



General Surgery

Instrumentation & Accessories

Table of Contents

Product Range at a Glance



Chapter 01

Diagnostik

p. 8 - 15

Diagnostics

p. 8 - 15

Diagnostic

p. 8 - 15

Diagnóstico

p. 8 - 15



Chapter 02

Anästhesie, Absaugung, Laryngoskopie

p. 16 - 21

Anesthesia, Aspiration, Laryngoscopes

p. 16 - 21

Anesthésie, Aspiration, Laryngoscopes

p. 16 - 21

Anestesia, Aspiración, Laringoscopios

p. 16 - 21



Chapter 03

Skalpellklingen, Skalpellgriffe, OP-Messer, Allgemeine Chirurgie

p. 22 - 30

Scalpelblades, Scalpelhandles, Operating Knives, Comon Surgery

p. 22 - 30

Bistouris, manches de bistouris, couteaux, chirurgie générale

p. 22 - 30

Hojasy mangos de bisturí, cuchillos, cirugía general

p. 22 - 30



Chapter 04

Chirurgische Scheren

p. 32 - 59

Surgical Scissors

p. 32 - 59

Ciseaux à chirurgie

p. 32 - 59

Tijeras para cirugía

p. 32 - 59



Chapter 05

Ophthalmologie und Mikroscheren

p. 60 - 64

Ophthalmology and Micro Scissors

p. 60 - 64

Ciseaux oculaires, micro-ciseaux

p. 60 - 64

Micro-tijeras, tijeras para oftalmología

p. 60 - 64



Chapter 06

Pinzetten

p. 66 - 78

Dressing and Tissue Forceps

p. 66 - 78

Pinces à dissection

p. 66 - 78

Pinzas de disección

p. 66 - 78

Chapter 07

Arterienklemmen

Haemostatic Forceps

Pincas hémostatiques

Pinzas hemostáticas

p. 80 - 110

p. 80 - 110

p. 80 - 110

p. 80 - 110

Chapter 08

Tuchklemmen, Korn- und Tupferzangen

Towel Clamps, Swab and Cotton Forceps

Pincas serre-tubes, pincas à champs, pincas à pansements et à polypes

Pinzas para tubos, pinzas de campo, pinzas para pólipos y esponjosp.

p. 112 - 119

p. 112 - 119

p. 112 - 119

112 - 119

Chapter 09

Wundhaken, Wundsperrer

Wound Retractors

Ecarteurs

Separadores

p. 120 - 154

p. 120 - 154

p. 120 - 154

p. 120 - 154

Chapter 10

Sonden, Spatel, Watteträger

Sounds, Spatula, Cotton Applicators

Porte-coton, sondes, stylets

Sondas, espátulas, porta-algodón

p. 156 - 161

p. 156 - 161

p. 156 - 161

p. 156 - 161

Chapter 11

Trokare

Trocars

Trocarts

Trócares

p. 162 - 167

p. 162 - 167

p. 162 - 167

p. 162 - 167

Chapter 12

Nadelhalter

Needle Holders

Porte-aiguilles

Porta-agujas

p. 168 - 182

p. 168 - 182

p. 168 - 182

p. 168 - 182

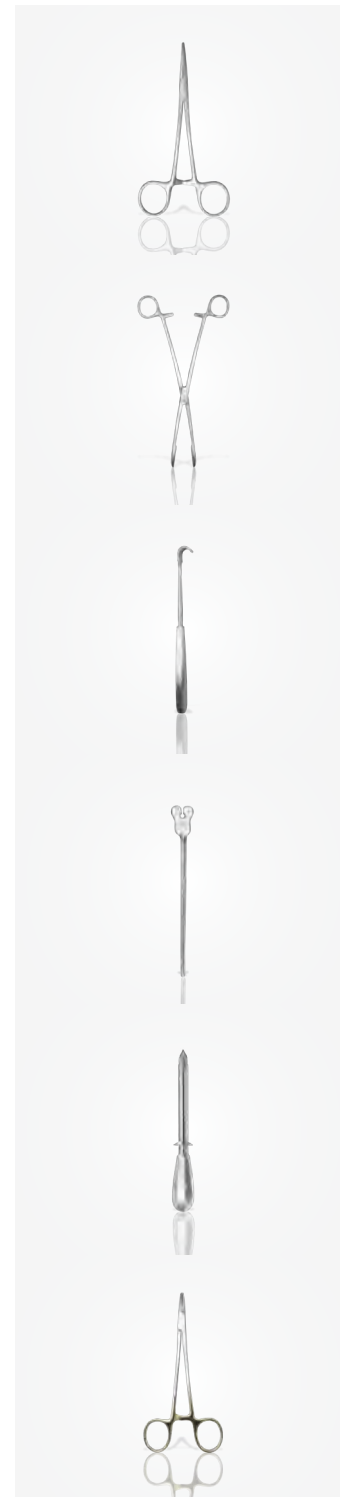

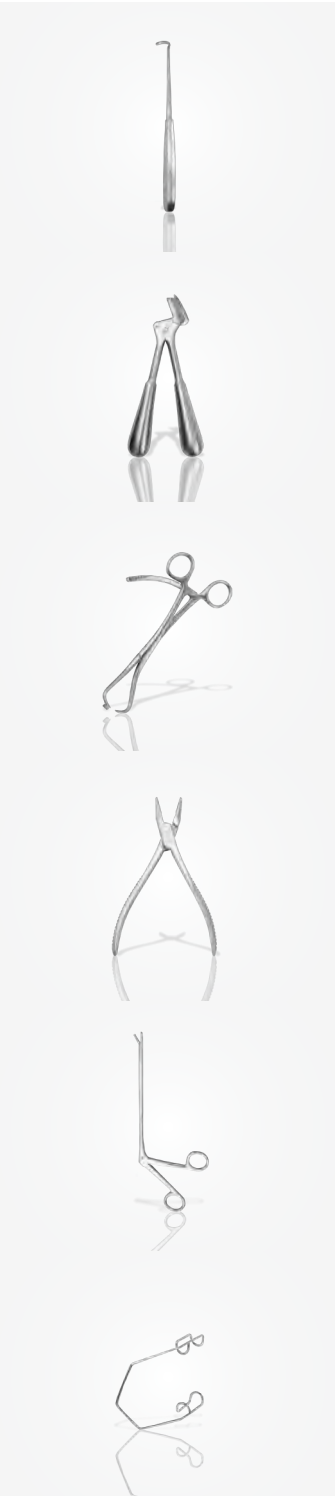

Chapter 13

Nahtinstrumente und Nähnadeln, Nahtbesteck, Sterilisationsinstrumente

p. 184 - 198

Suturing Instruments and Needles, Suturing Sets, Sterilizing Instruments

p. 184 - 198

Instruments et aiguilles à suture, instruments pour stérilisation

p. 184 - 198

Agujas e instrumentos de sutura, instrumentos para esterilización

p. 184 - 198

Chapter 14

Gipsverband, Elektrische Gipssäge

p. 200 - 204

Plaster of Paris, Electric Plaster Cast Cutter

p. 200 - 204

Appareil plâtres, scie électrique

p. 200 - 204

Vendajes enyesados, sierra eléctrica para yesos

p. 200 - 204

Chapter 15

Hohlmeißelzangen, Knochensplitter- und -halte-zangen, Knochenchirurgie

p. 206 - 246

Bone Rongeurs, Bone Cutting Forceps, Bone Holding Forceps, Bone Surgery

p. 206 - 246

Pincas gouges, pincas coupantes à os, daviens porte-os, chirurgie osseuse

p. 206 - 246

Pinzas-gubias, pinzas cortantes para huesos, cirugía ósea

p. 206 - 246

Chapter 16

Amputation, Handbohrer, Osteosynthese

p. 248 - 267

Amputation, Bone Drills, Osteosynthesis

p. 248 - 267

Amputation, perforateurs à main, ostéosynthèse

p. 248 - 267

Amputación, perforadores a mano, osteosíntesis

p. 248 - 267

Chapter 18

Neurochirurgie, Laminectomie, Gefäßchirurgie

p. 268 - 283

Neurosurgery, Laminectomy, Vascular Surgery

p. 268 - 283

Neurochirurgie, laminectomie, chirurgie vasculaire

p. 268 - 283

Neurocirugía, laminectomía, cirugía vascular

p. 268 - 283

Chapter 19

Ophthalmologie

p. 284 - 317

Ophthalmology

p. 284 - 317

Ophthalmologie

p. 284 - 317

Oftalmología

p. 284 - 317

Chapter 20

Otologie

Otology

Otologie

Otología

p. 318 - 340

p. 318 - 340

p. 318 - 340

p. 318 - 340

Chapter 21

Rhinologie

Rhinology

Rhinologie

Rinología

p. 342 - 366

p. 342 - 366

p. 342 - 366

p. 342 - 366

Chapter 22

Mund und Zunge

Mouth and Tongue

Bouche et langue

Boca y lengua

p. 368 - 375

p. 368 - 375

p. 368 - 375

p. 368 - 375

Chapter 23

Tonsillen

Tonsilectomy

Amygdales

Amígdalas

p. 376 - 382

p. 376 - 382

p. 376 - 382

p. 376 - 382

Chapter 24

Kehlkopf

Larynx

Larynx

Laringe

p. 384 - 388

p. 384 - 388

p. 384 - 388

p. 384 - 388

Chapter 25

Gastroskopie

Gastroscopy

Gastroscopie

Gastroscopía

p. 390 - 394

p. 390 - 394

p. 390 - 394

p. 390 - 394





Chapter 26

Tracheotomie, Kropf

Tracheostomy, Goitre

Trachéostomie, goitre

Traqueotomía, bocio

p. 396 - 400

p. 396 - 400

p. 396 - 400

p. 396 - 400

Chapter 27

Thorax, Rippenscheren, Rippenspreizer, Lungeninstrumente

Thorax, Rib Shears, Rib Spreader, Lung Instruments

Thorax, costotomes, ecarteur des côtes, poumon

Tórax, costótomos, separadores costales, pulmón

p. 402 - 414

p. 402 - 414

p. 402 - 414

p. 402 - 414

Chapter 28

Galle, Niere

Gall, Kidney

Voies biliaires, rein

Vesícula biliar, riñón

p. 416 - 422

p. 416 - 422

p. 416 - 422

p. 416 - 422

Chapter 29

Magen, Darm

Intestines, Stomach

Intestin, estomac

Intestinos, estómago

p. 424 - 435

p. 424 - 435

p. 424 - 435

p. 424 - 435

Chapter 30

Urologie

Urology

Urologie

Urología

p. 436 - 444

p. 436 - 444

p. 436 - 444

p. 436 - 444

Chapter 31

Rektum

Rectum

Rectum

Recto

p. 446 - 452

p. 446 - 452

p. 446 - 452

p. 446 - 452

Chapter 32

Gynäkologie

Gynecology

Gynécologie

Ginecología

p. 454 - 483

p. 454 - 483

p. 454 - 483

p. 454 - 483

Chapter 33

Geburtshilfe

Obstetrics

Obstétrique

Obstetricia

p. 484 - 492

p. 484 - 492

p. 484 - 492

p. 484 - 492

Chapter 34

Dermatologie

Dermatology

Dermatologie

Dermatología

p. 494 - 498

p. 494 - 498

p. 494 - 498

p. 494 - 498

Chapter 35

Sterilisierbehälter, Instrumentenschalen, Lösungsschalen, Nadeldosen

Trays, Instrument Cases, Solution Bowls, Needle Cases

Boîtes et plateaux à instruments, tambours à stérilisation, Boîtes à aiguilles

Tambores para esterilización, bandejas, cajas para agujas

p. 500 - 506

p. 500 - 506

p. 500 - 506

p. 500 - 506

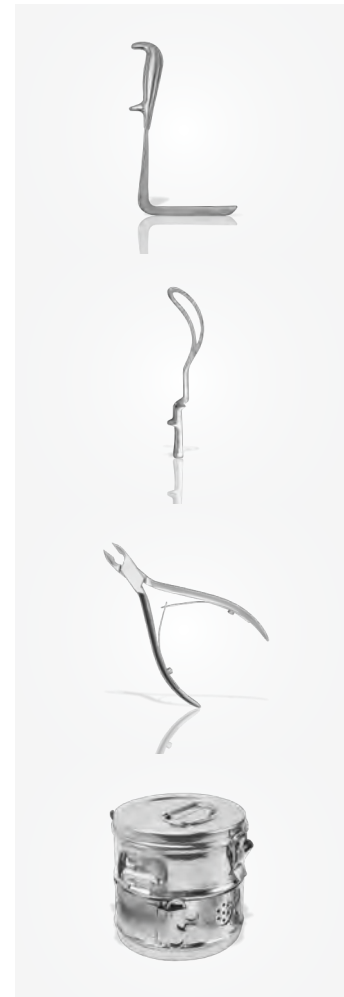

Chapter 01

Table of Contents

Diagnostik / **p. 8 - 15**

Diagnostics / **p. 8 - 15**

Diagnostic / **p. 8 - 15**

Diagnóstico / **p. 8 - 15**







01-1010.00



01-1109.00



01-1110.00



01-1111.00



COLLIN

01-1112.01

für Kinder
for children
pour enfants
para niños

01-1112.02

für Erwachsene
for adults
pour adultes
para adultos



FRANCKE

01-1113.00



01-1114.00



01-1200.00



01-1210.00



UNIVERSAL

01-1220.00

01

Stirnspiegel und Stirnlampen
Head Mirrors, Head Lights
Lampes frontales
Espejos y lámparas frontales



ZIEGLER
01-1300.90
Ø 90 mm



01-1300.91
Ø 90 mm



01-1300.92



CLAR
01-1310.00



CLAR
01-1312.00



01-1310.01



01-1312.01



01-1312.06



PINARD
01-1405.00

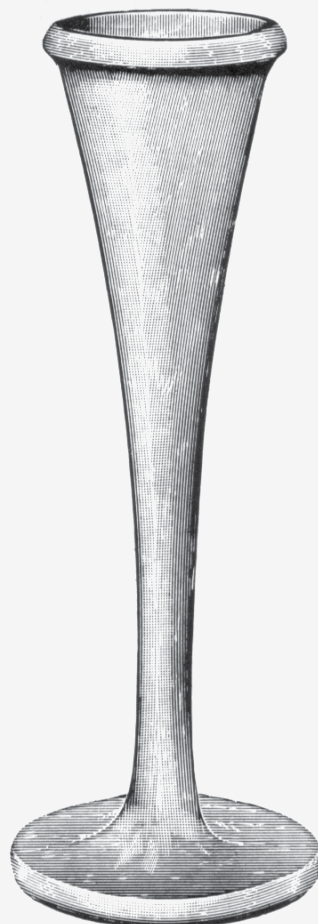

WINTER
01-1406.00

01

Perkussionshämmer
Percussion Hammers
 Marteaux-percuteurs
 Martillos de percusión



TAYLOR

01-1500.17

17 cm, 6 3/4"

01-1500.20

20 cm, 8"



TRAUBE

01-1504.16

16 cm, 6 1/4"



BABINSKY

01-1510.22

22 cm, 8 1/2"



TROEMNER

01-1511.24

24 cm, 9 1/2"



DEJERINE

01-1513.20

20 cm, 8"



DEJERINE

01-1514.20

20 cm, 8"



BERLINER

01-1515.17

17 cm, 6 3/4"

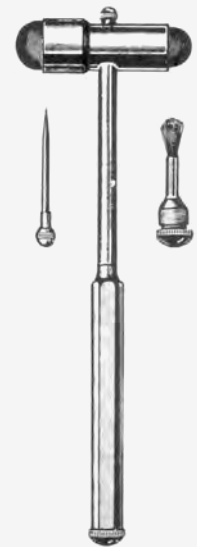

BUCK

01-1517.18

18 cm, 7"



BERTILLON
 01-1610.01



MOELTGEN
 01-1615.01



WARTENBERG
 01-1620.19
 19 cm, 7 1/2"



01-1625.10	10 cm, 4"
01-1625.20	20 cm, 8"
01-1625.30	30 cm, 12"
01-1625.50	50 cm, 20"



01-1627.15
 1,5 m

Chapter 02

Table of Contents

Anästhesie, Absaugung, Laryngoskopie / **p. 16 - 21**

Anesthesia, Aspiration, Laryngoscopes / **p. 16 - 21**

Anesthésie, Aspiration, Laryngoscopes / **p. 16 - 21**

Anestesia, Aspiración, Laringoscopios / **p. 16 - 21**





02

Absaugung
Aspiration
 Aspiration
 Aspiración



POOLE
02-1002.10
 Ø 10 mm, 30 Fr.



POOLE
02-1004.08
 Ø 8 mm, 23 Fr.



YANKAUER
02-1005.27
 27 cm, 10 1/2"



MAGILL



02-1010.17
 17 cm, 6 3/4"



02-1010.20
 20 cm, 8"

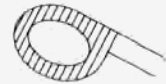

02-1010.25
 25 cm, 10"



MC INTOSH	
02-2011.00	Fig. 1 - 4
02-2013.00	Fig. 2 - 4

MC INTOSH cold light	
02-2021.00	Fig. 1 - 4
02-2023.00	Fig. 2 - 4

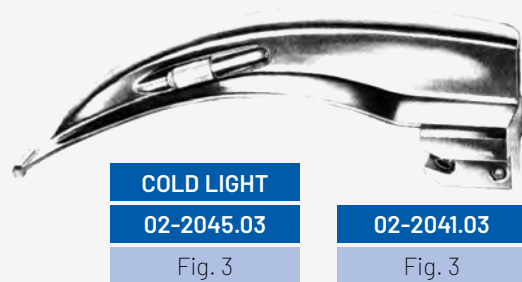

02

Laryngoskopie
Laryngoscopes
Laryngoscopes
Laringoscopios



FOREGGER

02-2032.00	Fig. 1 - 4
-------------------	------------

02-2030.00	Fig. 2 - 4
-------------------	------------



02-2046.00

Fig. 1



02-2046.01

Fig. 2



02-2046.03

Fig. 3



02-2046.04

Fig. 4



02-2050.28	28 mm
02-2050.37	37 mm



02-2051.01
Fig. 1



02-2051.02
Fig. 2 - 4



COLD LIGHT
02-2055.02



COLD LIGHT
02-2056.00

Chapter 03

Table of Contents

Skalpellsklingen, Skalpellsgriffe, OP-Messer, Allgemeine Chirurgie / **p. 22 - 30**

Scalpelblades, Scalpelhandles, Operating Knives, Comon Surgery / **p. 22 - 30**

Bistouris, manches de bistouris, couteaux, chirurgie générale / **p. 22 - 30**

Hojas y mangos de bisturí, cuchillos, cirugía general / **p. 22 - 30**





03

Skalpellgriffe- und Klingen, OP-Messer, allgemeine Chirurgie

Scalpellhandles, -blades, Knives

Manches de bistouris, lames

Mangos de bisturios, hojas



03-0100.03

No. 3



03-0100.13

No. 3L



03-0102.04

No. 4



03-0102.14

No. 4L



03-0103.07

No. 7



03-0103.17

No. 7K



03-0104.08

No. 8



03-0105.10



03-0105.11



03-0105.12



03-0106.12



03-0105.13



03-0105.14



03-0105.15



03-0106.15



03-0105.16



03-0105.17



03-0112.18



03-0112.19



03-0112.20



03-0112.21



03-0112.22



03-0112.23



03-0112.24



03-0113.24



03-0112.25



03-0112.34



03-0112.36



03-0113.36

03

Rasierklingenbrecher
Blade Breakers
Casse-lames
Rompe-hojas



TROUTMAN

03-0120.09

9 cm, 3 1/2"



TROUTMAN

03-0121.09

9 cm, 3 1/2"



Ø 8 mm

CASTROVIEJO

03-0124.13

13 cm, 5"



03-0220.01

03-0220.02

03-0220.03

03-0220.04

03-0220.05



03-0220.06

03-0220.07

03-0220.08

03-0220.09

03-0220.10



03

OP-Skalpelle mit Metallheft
Scalpels with Metal Handle
 Bistouris, manche metal
 Bisturías con mango metálico

Amputationsmesser
 Amputating Knives
 Couteaux à amputation
 Cuchillos para amputación



PARKER
03-0224.01
Fig. 1



PARKER
03-0224.02
Fig. 2



03-0318.13	13 cm, 5"
03-0318.16	16 cm, 6 1/4"
03-0318.19	19 cm, 7 1/2"
03-0318.22	22 cm, 8 3/4"
03-0318.28	28 cm, 11"



LISTON	
03-0320.17	17 cm, 6 3/4"
03-0320.20	20 cm, 8"



Resektionsmesser
 Resection Knives
 Couteaux à résection
 Cuchillos para resección

LANGENBECK
 03-0306.05



LANGENBECK
 03-0308.05



Knorpelmesser
 Cartilage Knife
 Couteaux à cartilage
 Cuchillo para cartílagos

VIRCHOW
 03-0510.25
 25 cm, 10"



Messer
 Knives
 cerveau
 cerebro

03-0590.16	16 cm, 6 1/4"
03-0590.20	20 cm, 8"
03-0590.24	24 cm, 9 1/2"



SCHINK
03-0420.00



03-0420.01

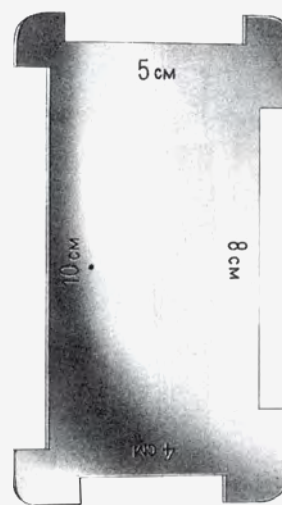

03-0420.02

Chapter 04

Table of Contents

Chirurgische Scheren / **p. 32 - 59**

Surgical Scissors / **p. 32 - 59**

Ciseaux à chirurgie / **p. 32 - 59**

Tijeras para cirugía / **p. 32 - 59**





04

Chirurgische Scheren
Operating Scissors
 Ciseaux à chirurgie
 Tijeras para cirugía



04-1120.10	10,5 cm, 4"
04-1120.11	11 cm, 4 1/4"
04-1120.13	13 cm, 5"
04-1120.14	14,5 cm, 5 1/2"
04-1120.15	15,5 cm, 6"
04-1120.16	16,5 cm, 6 1/2"
04-1120.18	18 cm, 7"
04-1120.20	20 cm, 8"



04-1130.10	10,5 cm, 4"
04-1130.11	11 cm, 4 1/4"
04-1130.13	13 cm, 5"
04-1130.14	14,5 cm, 5 1/2"
04-1130.15	15,5 cm, 6"
04-1130.16	16,5 cm, 6 1/2"
04-1130.18	18 cm, 7"
04-1130.20	20 cm, 8"



04-1140.10	10,5 cm, 4"
04-1140.11	11 cm, 4 1/4"
04-1140.13	13 cm, 5"
04-1140.14	14,5 cm, 5 1/2"
04-1140.15	15,5 cm, 6"
04-1140.16	16,5 cm, 6 1/2"
04-1140.18	18 cm, 7"
04-1140.20	20 cm, 8"



04-1121.10	10,5 cm, 4"
04-1121.11	11 cm, 4 1/4"
04-1121.13	13 cm, 5"
04-1121.14	14,5 cm, 5 1/2"
04-1121.15	15,5 cm, 6"
04-1121.16	16,5 cm, 6 1/2"
04-1121.18	18 cm, 7"
04-1121.20	20 cm, 8"



04-1131.10	10,5 cm, 4"
04-1131.11	11 cm, 4 1/4"
04-1131.13	13 cm, 5"
04-1131.14	14,5 cm, 5 1/2"
04-1131.15	15,5 cm, 6"
04-1131.16	16,5 cm, 6 1/2"
04-1131.18	18 cm, 7"
04-1131.20	20 cm, 8"



04-1141.10	10,5 cm, 4"
04-1141.11	11 cm, 4 1/4"
04-1141.13	13 cm, 5"
04-1141.14	14,5 cm, 5 1/2"
04-1141.15	15,5 cm, 6"
04-1141.16	16,5 cm, 6 1/2"



DEAVER



04-1224.14

14 cm, 5 1/2"



04-1225.14

14 cm, 5 1/2"



DEAVER



04-1242.14

14 cm, 5 1/2"



04-1243.14

14 cm, 5 1/2"



DEAVER



04-1256.14

14 cm, 5 1/2"



04-1257.14

14 cm, 5 1/2"



04-1220.14

14 cm, 5 1/2"

04

Chirurgische Scheren
Operating Scissors
 Ciseaux à chirurgie
 Tijeras para cirugía



MAYO

04-1260.14	14,5 cm, 5 1/2"
04-1260.17	17 cm, 6 3/4"
04-1260.23	23 cm, 9"



MAYO

04-1261.14	14,5 cm, 5 1/2"
04-1261.17	17 cm, 6 3/4"
04-1261.23	23 cm, 9"

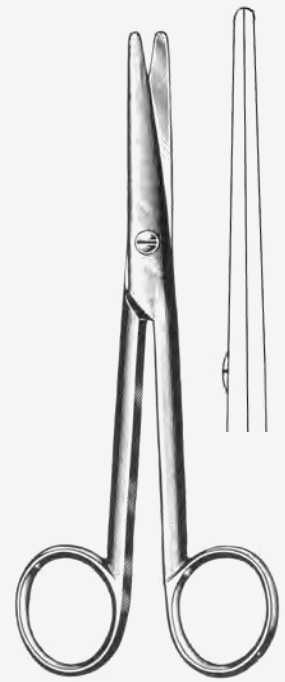

MAYO-STILLE

04-1270.15	15 cm, 5 3/4"
04-1270.17	17 cm, 6 3/4"

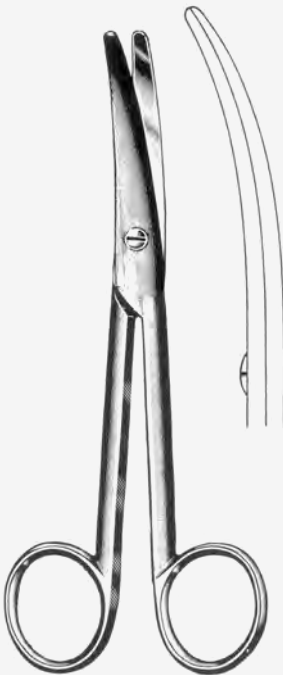

MAYO-STILLE

04-1271.15	15 cm, 5 3/4"
04-1271.17	17 cm, 6 3/4"

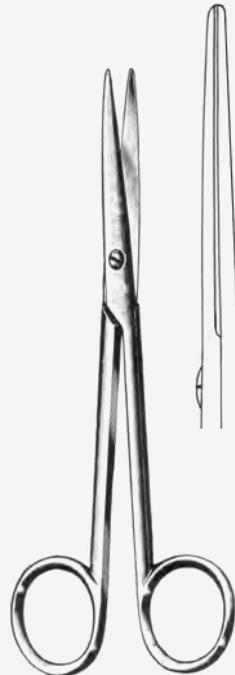

LEXER

04-1300.16	16 cm, 6 1/4"
04-1300.21	21 cm, 8 1/4"

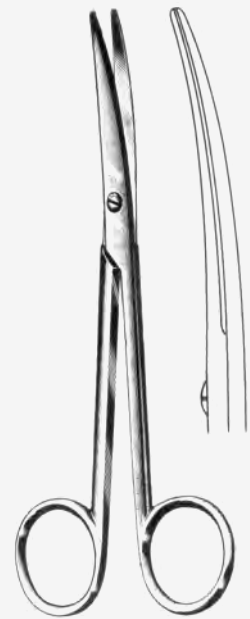

LEXER

04-1301.16	16 cm, 6 1/4"
04-1301.21	21 cm, 8 1/4"



LEXER-BABY



04-1310.10

10 cm, 4"



04-1311.10

10 cm, 4"



MAYO-NOBLE



04-1280.17

17 cm, 6 3/4"

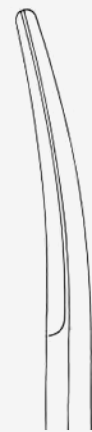

04-1281.17

17 cm, 6 3/4"

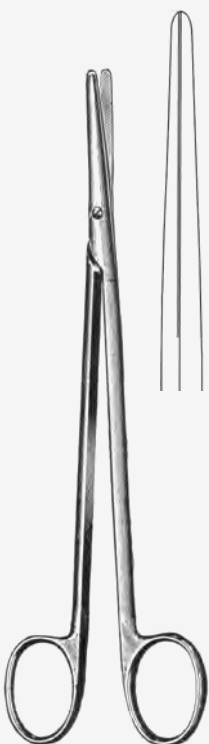

METZENBAUM

04-1320.11

10,5 cm, 4"

04-1320.15

15 cm, 5 3/4"

04-1320.18

18 cm, 7"

04-1320.20

20 cm, 8"

04-1320.23

23 cm, 9"

04-1320.25

25 cm, 10"

04-1320.28

28 cm, 11"

04-1320.30

30 cm, 12"



METZENBAUM

04-1321.11

10,5 cm, 4"

04-1321.15

15 cm, 5 3/4"

04-1321.18

18 cm, 7"

04-1321.20

20 cm, 8"

04-1321.23

23 cm, 9"

04-1321.25

25 cm, 10"

04-1321.28

28 cm, 11"

04-1321.30

30 cm, 12"

04

Chirurgische Scheren
Operating Scissors
 Ciseaux à chirurgie
 Tijeras para cirugía



04-1332.15	15 cm, 5 3/4"
04-1332.18	18 cm, 7"
04-1332.20	20 cm, 8"
04-1332.23	23 cm, 9"

METZENBAUM-FINO



04-1331.15	15 cm, 5 3/4"
04-1331.18	18 cm, 7"
04-1331.20	20 cm, 8"
04-1331.23	23 cm, 9"

METZENBAUM-FINO

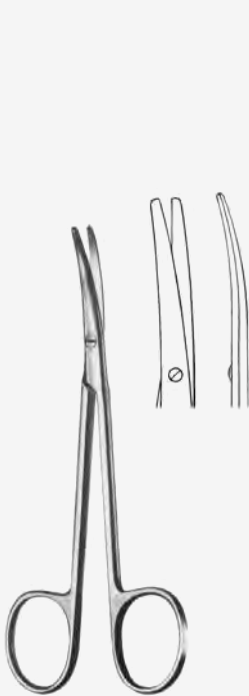

METZENBAUM

04-1339.12

12 cm, 5"



METZENBAUM-S

04-1341.18

18 cm, 7"

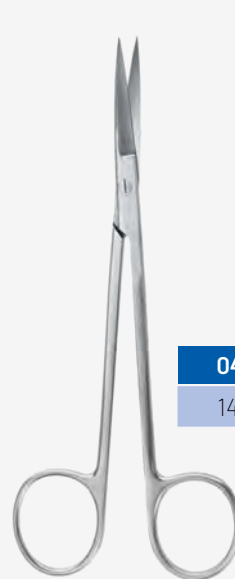

SANVENERO

04-1350.14

14 cm, 5 1/2"

04-1351.14

14 cm, 5 1/2"

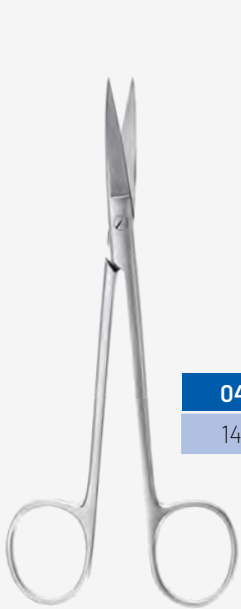

04-1352.14

14 cm, 5 1/2"

JOSEPH



04-1353.14

14 cm, 5 1/2"

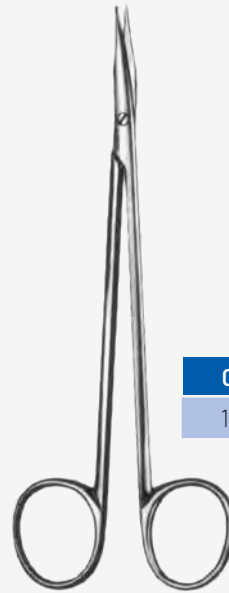

04-1370.15

15 cm, 5 3/4"

REYNOLDS



04-1371.15

15 cm, 5 3/4"

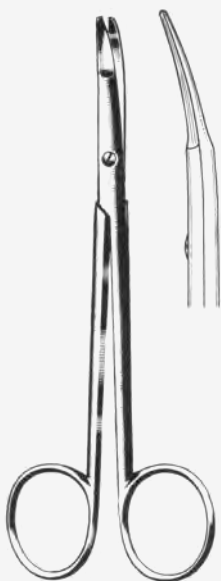

KILNER

04-1360.12

12 cm, 4 3/4"

04-1360.15

15 cm, 5 3/4"



04-1380.09

9 cm, 3 1/2"

04-1380.11

11 cm, 4 1/2"

Irisscheren
 Iris Scissors
 Ciseaux à iris
 Tijeras para iris

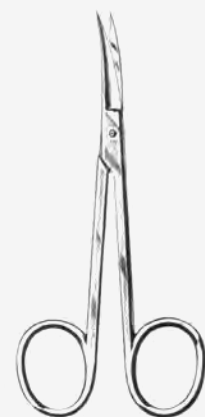

04-1381.09

9 cm, 3 1/2"

04-1381.11

11 cm, 4 1/2"

04

Chirurgische Scheren
Operating Scissors
 Ciseaux à chirurgie
 Tijeras para cirugía

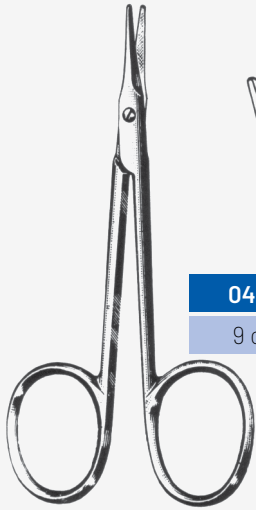

04-1391.09

9 cm, 3 1/2"



04-1393.09

9 cm, 3 1/2"

AEBLI

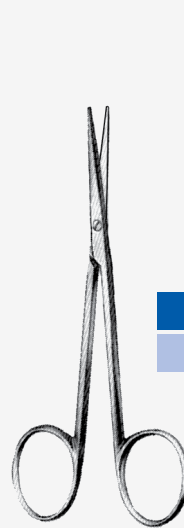

04-1400.11

11 cm, 4 1/4"



04-1401.11

11 cm, 4 1/4"

Strabismusscheren
 Strabismus Scissors
 Ciseaux à strabisme
 Tijeras para estrabismo

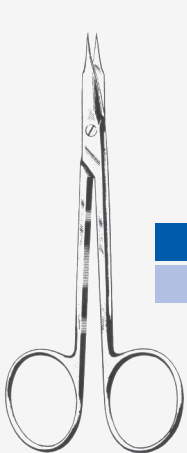

04-1394.11

11 cm, 4 1/4"



04-1395.11

11 cm, 4 1/4"

Sehnenscheren
 Tenotomy Scissors
 Ciseaux à ténotomie
 Tijeras para tenotomía

STEVENS



04-1396.11

11 cm, 4 1/4"



04-1397.11

11 cm, 4 1/4"

Sehnenscheren
 Tenotomy Scissors
 Ciseaux à ténotomie
 Tijeras para tenotomía

STEVENS

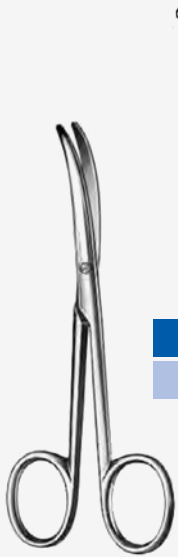

04-1406.11
 11 cm, 4 1/2"



04-1407.11
 11 cm, 4 1/2"

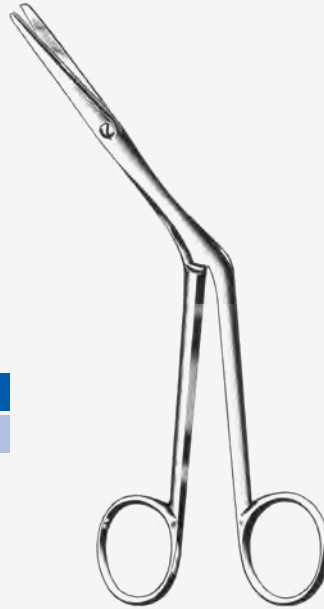

HEYMANN
04-1408.18
 18 cm, 7"



FOMON
04-1410.15
 15 cm, 5 3/4"



COTTLE
04-1415.16
 16 cm, 6 1/4"



DEAN
04-1435.17
 17 cm, 6 3/4"



Gezahnt
 Toothed
 Dentelée
 Dentada

DEAN
04-1437.17
 17 cm, 6 3/4"

04

Tonsillenscheren, Nasenscheren
Tonsil Scissors, Nasal Scissors
 Ciseaux pour les amygdales, Ciseaux nasaux
 Tijeras para amígdalas, Tijeras nasales

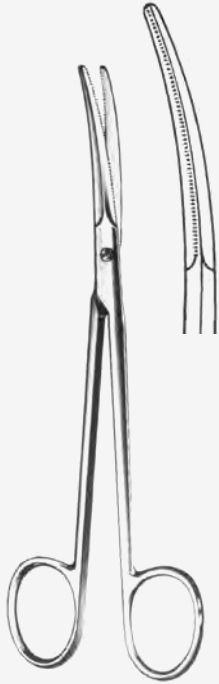

BEUSE
04-1431.14
 14 cm, 5 1/2"



BOETTCHER
04-1445.18
 18 cm, 7"

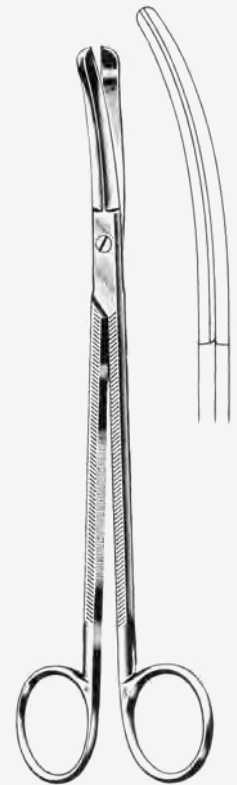

GOOD
04-1447.19
 19 cm, 7 1/2"



PRINCE
04-1449.17
 17 cm, 6 3/4"



04-1480.11
 11 cm, 4 3/4"

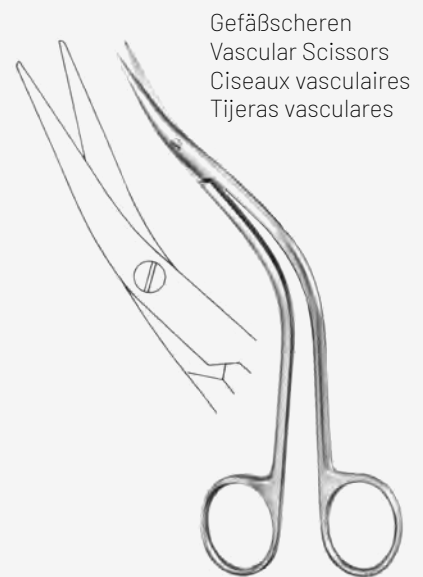

Gefäßscheren
 Vascular Scissors
 Ciseaux vasculaires
 Tijeras vasculares

DE BAKELY
04-1505.15 spitz / sharp
04-1507.15 stumpf / blunt

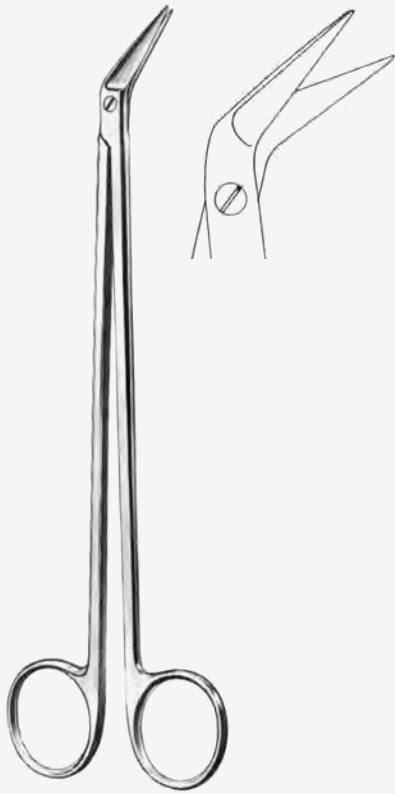

POTTS-DE MARTEL

04-1483.21 21 cm, 8 1/4"

04-1483.24 24 cm, 9 1/2"



POTTS-SMITH

19 cm, 7 1/2"



04-1490.25

25°

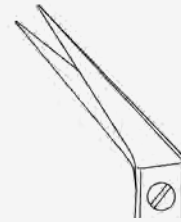

04-1490.40

40°

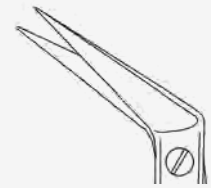

04-1490.60

60°



DE BAKEY



25°

04-1501.16 16 cm, 6 1/4"

04-1501.23 23 cm, 9"

04-1501.28 28 cm, 11"

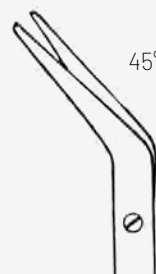

45°

04-1502.16 16 cm, 6 1/4"

04-1502.23 23 cm, 9"

04-1502.28 28 cm, 11"

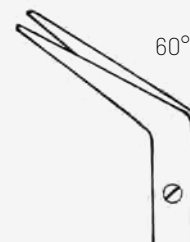

60°

04-1503.16 16 cm, 6 1/4"

04-1503.23 23 cm, 9"

04-1503.28 28 cm, 11"

04

Gynäkologische Scheren
Gynaecological Scissors
 Ciseaux gynécologiques
 Tijeras ginecológicas

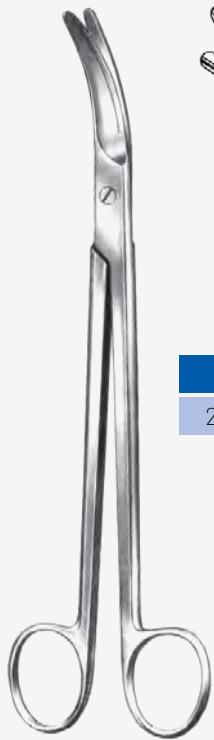

04-1521.22
 22,5 cm, 8 3/4"



04-1523.22
 22,5 cm, 8 3/4"

Parametriumscheren
 Parametrium Scissors
 Ciseaux à parametrium
 Tijeras para parametrio

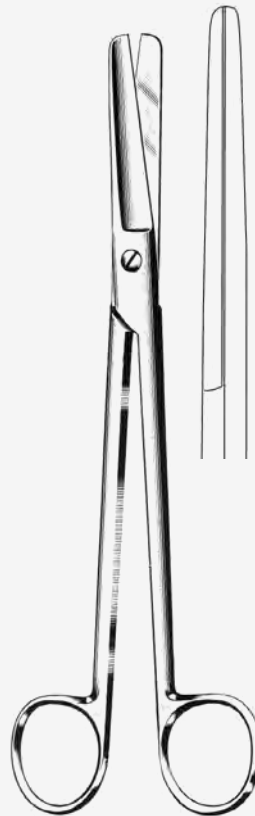

SIMS
04-1530.20 20 cm, 8"
04-1530.23 23 cm, 9"



SIMS
04-1531.20 20 cm, 8"
04-1531.23 23 cm, 9"

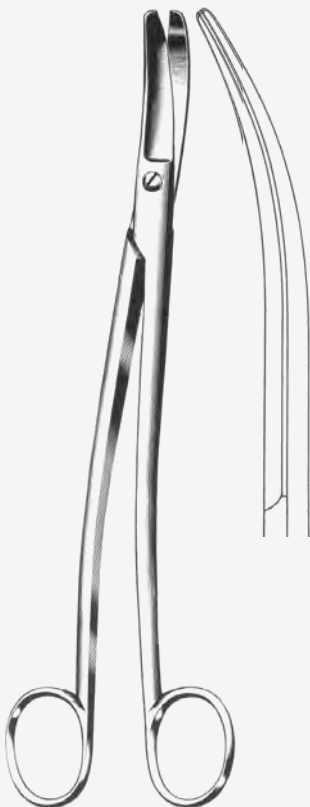

SIEBOLD
04-1543.24
 24 cm, 9 1/2"

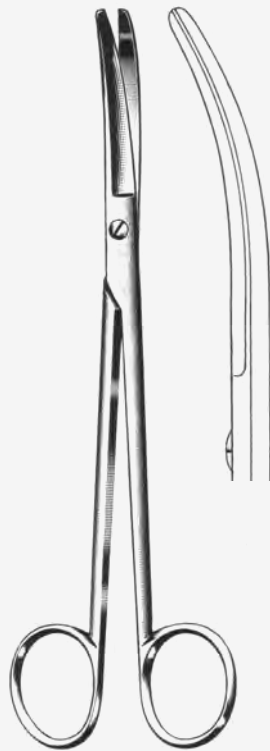

WERTHEIM
04-1545.22
 22,5 cm, 8 3/4"



DOYEN



04-1550.17
 17,5 cm, 7"



04-1551.17
 17,5 cm, 7"

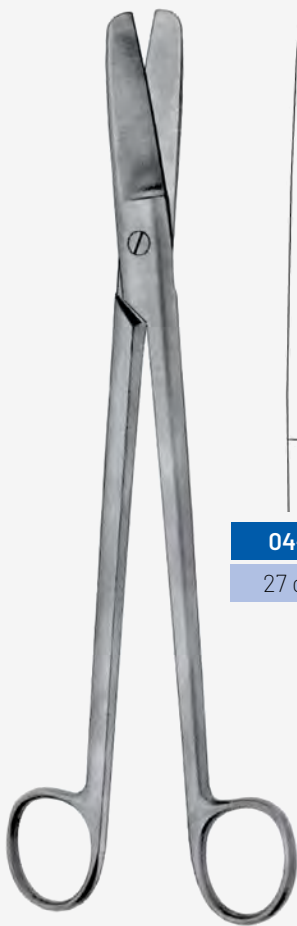

DUBOIS



04-1556.27
 27 cm, 10 1/2"



04-1557.27
 27 cm, 10 1/2"

Nabelschnurscheren
 Umbilical Cord Scissors
 Ciseaux pour le cordon ombilical
 Tijeras para el cordón umbilical

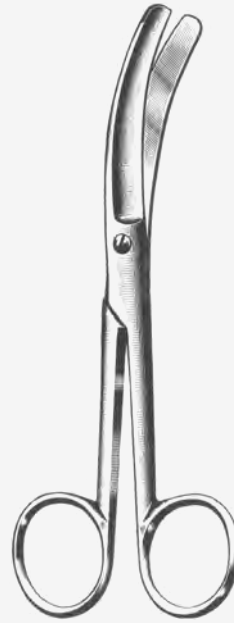

BUSCH
04-1571.16
 16 cm, 6 1/4"



SCHUMACHER
04-1573.15
 15 cm, 5 3/4"

Nabelschnurscheren
 Umbilical Cord Scissors
 Ciseaux pour le cordon ombilical
 Tijeras para el cordón umbilical



USA MODELL
04-1570.10
 10,5 cm, 4"

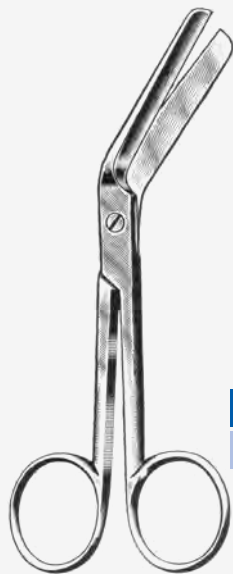

BRAUN-STADLER

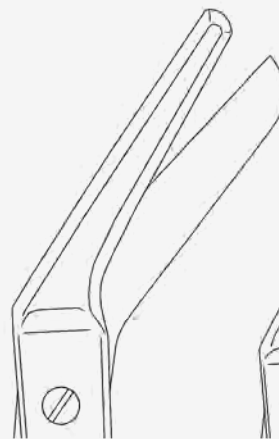

04-1580.14
 14,5 cm, 5 1/2"

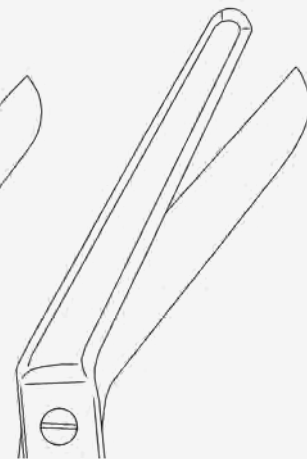

04-1580.22
 22 cm, 8 1/2"

Episiotomiescheren
 Episiotomy Scissors
 Ciseaux à épisiotomie
 Tijeras para episiotomía

04

Chirurgische Scheren, Präparierscheren
Operating Scissors, Dissecting Scissors
 Ciseaux à chirurgie, Ciseaux à dissection
 Tijeras para cirugía, Tijeras de disección



KELLY

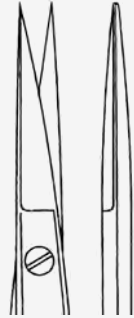

04-1560.16 16 cm, 6 1/4"
 04-1560.18 18 cm, 7"



04-1561.16 16 cm, 6 1/4"
 04-1561.18 18 cm, 7"



STRULLY
 04-1601.22
 22 cm, 8 1/2"



04-1590.11
 11 cm, 4 1/4"



04-1591.11
 11 cm, 4 1/4"



04-1592.15
 15 cm, 5 3/4"



04-1593.15
 15 cm, 5 3/4"



TOENNIS-ADSON

04-1610.18

18 cm, 7"

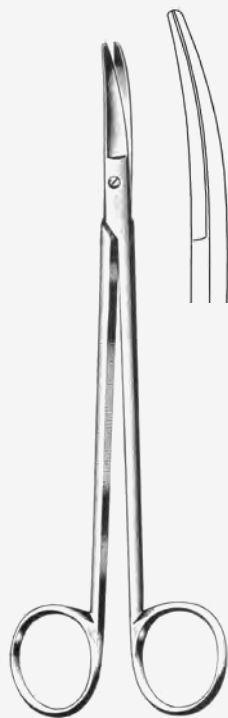

TOENNIS-ADSON

04-1611.18

18 cm, 7"



MC INDOE

04-1614.19

19 cm, 7 1/2"



DANDY

04-1617.17

17 cm, 6 3/4"



SCHMIEDEN-TAYLOR

04-1619.17

17 cm, 6 3/4"



THOREK

04-1623.19

19 cm, 7 1/2"



04-1623.25

25 cm, 10"

04

Präparierscheren, Thoraxscheren
Dissecting Scissors, Thorax Scissors
Ciseaux à dissection, Ciseaux thoraciques
Tijeras de disección, Tijeras torácicas



CRAFOORD

04-1621.30

30 cm, 12"

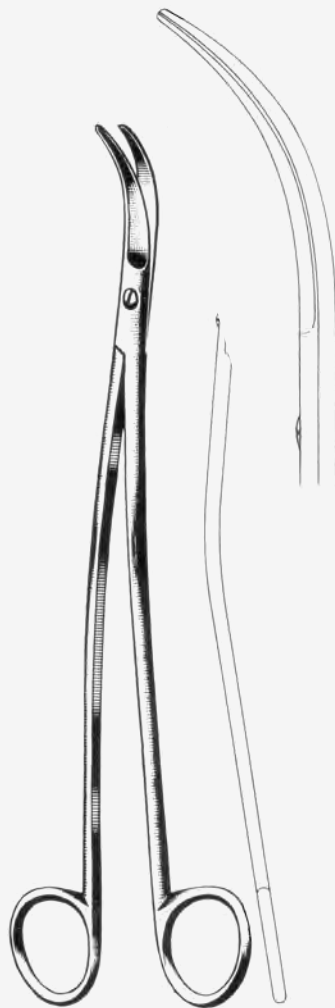

SATINSKY

04-1631.24

24,5 cm, 9 3/4"

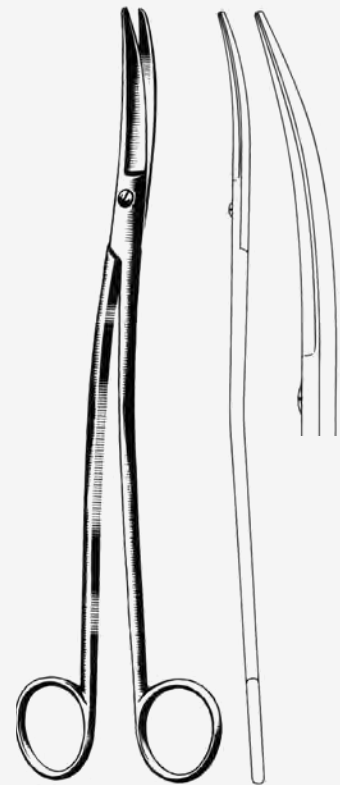

KLINKENBERGH-LOTH

04-1641.23

23 cm, 9"

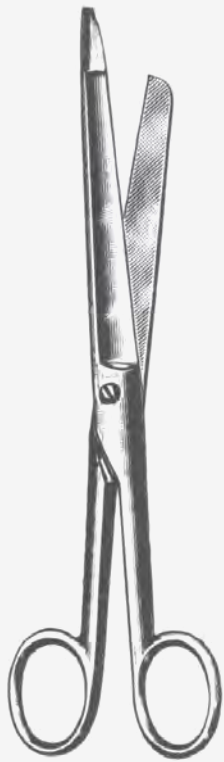

04-1650.21

21 cm, 8 1/4"

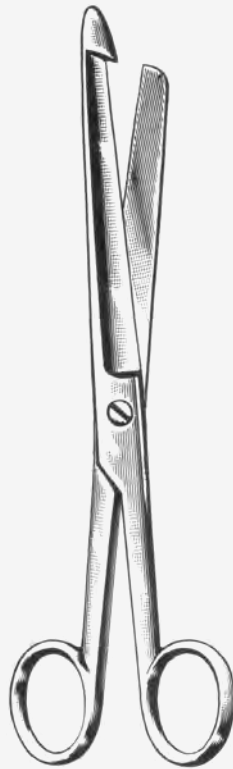

04-1652.21

21 cm, 8 1/4"

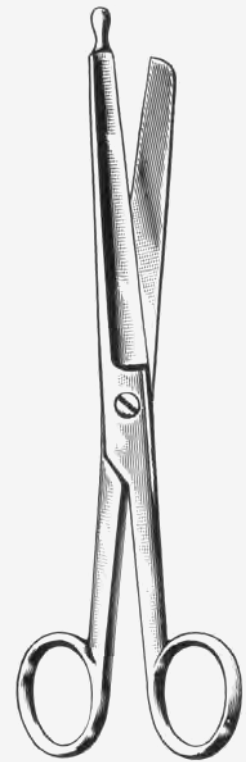

04-1654.21

21 cm, 8 1/4"



SPENCER

04-1660.09

9 cm, 3 1/2"



SPENCER

04-1662.11

11 cm, 4 1/4"



NORTHBENT

04-1663.13

13 cm, 5"



LITTAUER

04-1664.14

14 cm, 5 1/2"



HEATH

04-1669.15

15 cm, 5 3/4"

04

Zahnfleischscheren
Gum Scissors
Ciseaux pour gencive
Tijeras para encías



04-1670.13

13 cm, 5"



04-1671.13

13 cm, 5"



WAGNER

04-1674.12

12 cm, 4 3/4"



04-1675.12

12 cm, 4 3/4"



QUINBY

04-1677.12

12 cm, 4 3/4"



UNIVERSAL
04-1731.12
 12 cm, 4 3/4"



BEEBEE



04-1740.10
 10 cm, 4"



04-1741.10
 10 cm, 4"



04-1742.10
 10 cm, 4"



04-1743.10
 10 cm, 4"



SMITH
04-1748.15 15 cm, 5 3/4"
04-1748.16 16 cm, 6 1/4"
04-1748.18 18 cm, 7"
04-1748.20 20 cm, 8"



LISTER
04-1751.11 11 cm, 4 1/4"
04-1751.14 14 cm, 5 1/2"
04-1751.18 18 cm, 7"
04-1751.20 20 cm, 8"



BERGMANN
04-1761.23
 23 cm, 9"

04

Verbandscheren
Bandage Scissors
 Ciseaux à pansements
 Tijeras para vendajes



ESMARCH

04-1763.20	20 cm, 8"
04-1763.22	22 cm, 8 1/2"



BRUNS

04-1775.23	23 cm, 9"
-------------------	-----------



BRUNS

04-1777.23	23 cm, 9"
-------------------	-----------



KNOWLES

04-1770.14	14 cm, 5 1/2"
-------------------	---------------



LORENZ

04-1773.23	23 cm, 9"
-------------------	-----------



WALTON

04-1780.20	20 cm, 8"
-------------------	-----------



UNIVERSAL

04-1782.15	15 cm, 5 3/4"
04-1782.18	18 cm, 7"



04-1122.14 14,5 cm, 5 1/2"

04-1122.16 16,5 cm, 6 1/2"



04-1132.14 14,5 cm, 5 1/2"

04-1132.16 16,5 cm, 6 1/2"



04-1142.14 14,5 cm, 5 1/2"

04-1142.16 16,5 cm, 6 1/2"



04-1123.14 14,5 cm, 5 1/2"

04-1123.16 16,5 cm, 6 1/2"



04-1133.14 14,5 cm, 5 1/2"

04-1133.16 16,5 cm, 6 1/2"



04-1143.14 14,5 cm, 5 1/2"

04-1143.16 16,5 cm, 6 1/2"

04

Scheren mit Hartmetallschneiden
Scissors with Tungsten Carbide Edges
 Ciseaux avec des lames en tungstène
 Tijeras con filos de carburo de tungsteno



04-1234.14

14 cm, 5 1/2"

04-1235.14

14 cm, 5 1/2"

DEAVER



04-1252.14

14 cm, 5 1/2"

04-1253.14

14 cm, 5 1/2"

DEAVER



MAYO

04-1264.14 14,5 cm, 5 1/2"

04-1264.17 17 cm, 6 3/4"

04-1264.23 23 cm, 9"

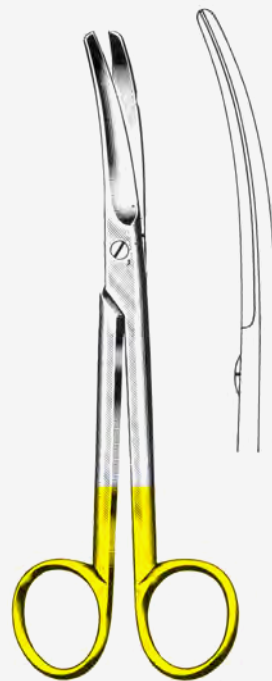

MAYO

04-1265.14 14,5 cm, 5 1/2"

04-1265.17 17 cm, 6 3/4"

04-1265.23 23 cm, 9"



MAYO-STILLE

04-1274.15	15 cm, 5 3/4"
04-1274.17	17 cm, 6 3/4"



MAYO-STILLE

04-1275.15	15 cm, 5 3/4"
04-1275.17	17 cm, 6 3/4"

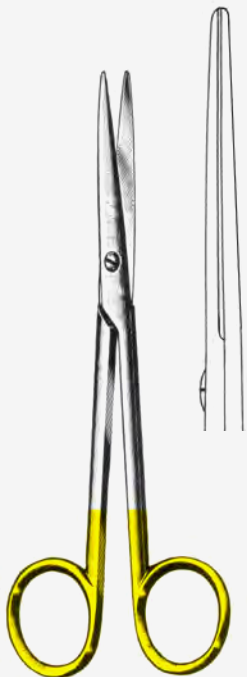

LEXER

04-1304.16	16 cm, 6 1/4"
04-1304.21	21 cm, 8 1/4"

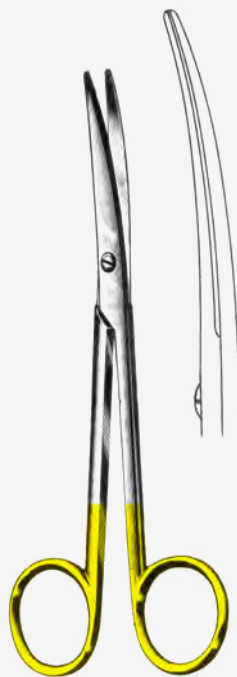

LEXER

04-1305.16	16 cm, 6 1/4"
04-1305.21	21 cm, 8 1/4"

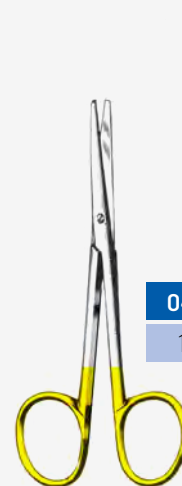

LEXER-BABY

04-1314.10	10 cm, 4"
-------------------	-----------

04-1315.10	10 cm, 4"
-------------------	-----------

04

Scheren mit Hartmetallschneiden
Scissors with Tungsten Carbide Edges
 Ciseaux avec des lames en tungstène
 Tijeras con filos de carburo de tungsteno

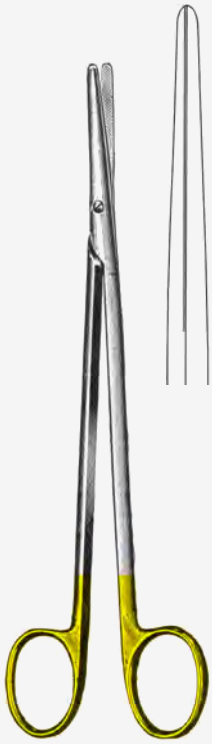

04-1324.11	10,5 cm, 4"
04-1324.15	15 cm, 5 3/4"
04-1324.18	18 cm, 7"
04-1324.20	20 cm, 8"
04-1324.23	23 cm, 9"
04-1324.25	25 cm, 10"
04-1324.28	28 cm, 11"
04-1324.30	30 cm, 12"

METZENBAUM



04-1325.11	10,5 cm, 4"
04-1325.15	15 cm, 5 3/4"
04-1325.18	18 cm, 7"
04-1325.20	20 cm, 8"
04-1325.23	23 cm, 9"
04-1325.25	25 cm, 10"
04-1325.28	28 cm, 11"
04-1321.30	30 cm, 12"

METZENBAUM

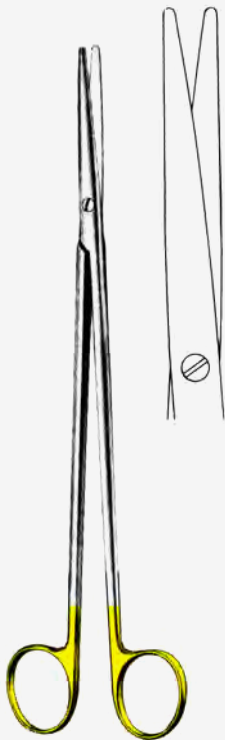

04-1336.15	15 cm, 5 3/4"
04-1336.18	18 cm, 7"
04-1336.20	20 cm, 8"
04-1336.23	23 cm, 9"
04-1336.25	25 cm, 10"
04-1336.28	28 cm, 11"

METZENBAUM-FINO



04-1337.15	15 cm, 5 3/4"
04-1337.18	18 cm, 7"
04-1337.20	20 cm, 8"
04-1337.23	23 cm, 9"
04-1337.25	25 cm, 10"
04-1337.28	28 cm, 11"

METZENBAUM-FINO

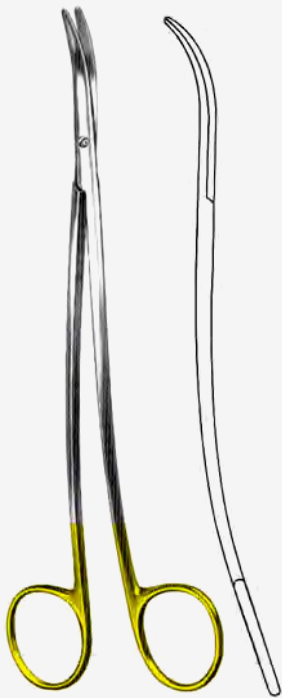

METZENBAUM-S
 04-1345.18
 18 cm, 7"



KILNER
 04-1364.12 12 cm, 4 3/4"
 04-1364.15 15 cm, 5 3/4"

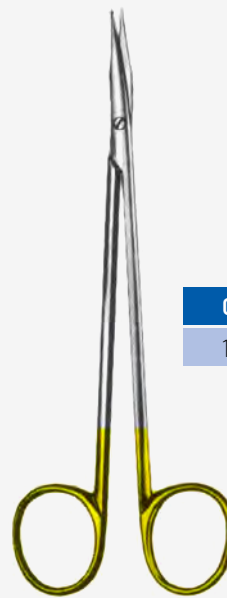

REYNOLDS

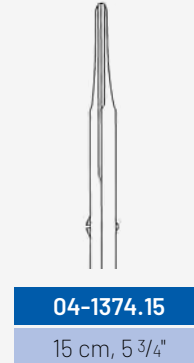

04-1374.15
 15 cm, 5 3/4"

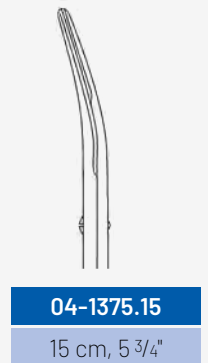

04-1375.15
 15 cm, 5 3/4"



Irisscheren
 Iris Scissors
 Ciseaux à iris
 Tijeras para iris

04-1384.11
 11 cm, 4 1/4"



04-1385.11
 11 cm, 4 1/4"



04-1404.11
 11 cm, 4 1/4"



04-1405.11
 11 cm, 4 1/4"

Strabismusscheren
 Strabismus Scissors
 Ciseaux à strabisme
 Tijeras para estrabismo

04

Scheren mit Hartmetallschneiden
Scissors with Tungsten Carbide Edges
 Ciseaux avec des lames en tungstène
 Tijeras con filos de carburo de tungsteno

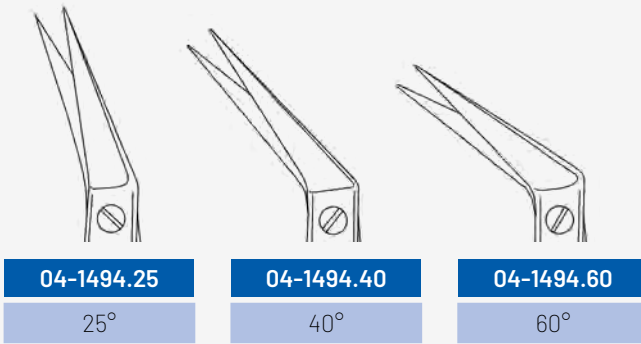

POTTS-SMITH
 19 cm, 7 1/2"



Parametriumscheren
 Parametrium Scissors
 Ciseaux à parametrium
 Tijeras para parametrio

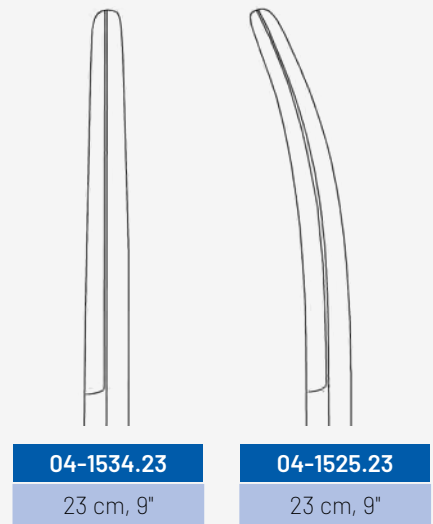
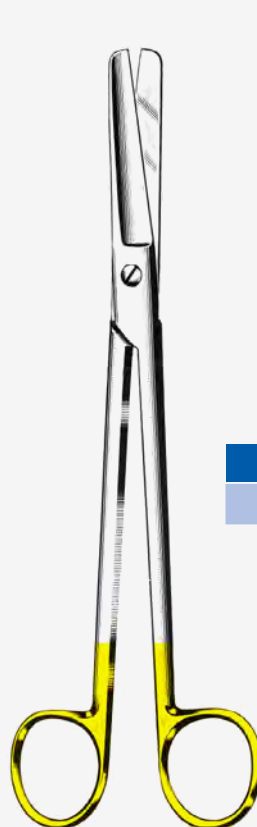

SIMS



UNIVERSAL

04-1735.12

12 cm, 4 3/4"



LISTER

04-1755.18

18 cm, 7"



BRUNS

04-1779.23

23 cm, 9"

Chapter 05

Table of Contents

Ophthalmologie und Mikroscheren / **p. 60 - 64**

Ophthalmology and Micro Scissors / **p. 60 - 64**

Ciseaux oculaires, micro-ciseaux / **p. 60 - 64**

Micro-tijeras, tijeras para oftalmología / **p. 60 - 64**





05

Augen- und Mikroscheren
Ophthalmic and Micro Scissors
Ciseaux oculaires et pour microchirurgie
Tijeras para oftalmología y microcirugía



WESTCOTT

05-1120.11

11 cm, 4 1/4"



WESTCOTT

05-1122.11

11 cm, 4 1/4"



NOYES

05-1124.12

12 cm, 4 3/4"



BARRAQUER

05-1131.10

5,5 cm, 2 1/4"



MC GUIRE

05-1133.10

10 cm, 4"

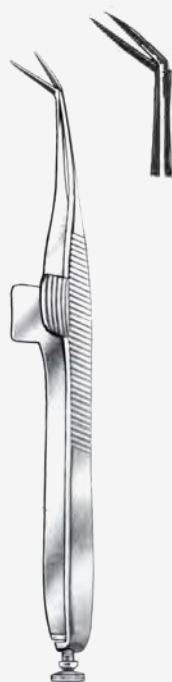

WECKER

05-1125.11

11 cm, 4 1/4"

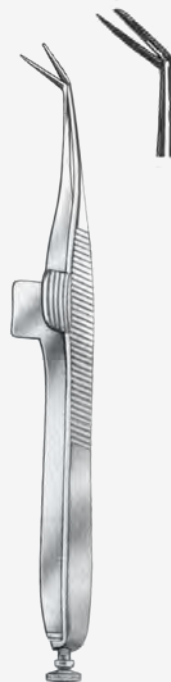

WECKER

05-1127.11

11 cm, 4 1/4"

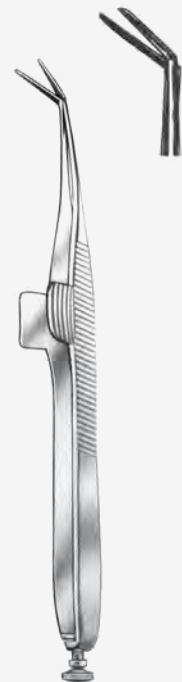

WECKER

05-1129.11

11 cm, 4 1/4"



CASTROVIEJO

05-1135.10

10 cm, 4"



CASTROVIEJO

05-1137.10

10 cm, 4"



VANNAS

05-1140.08

8 cm, 3 1/4"



VANNAS

05-1141.08

8 cm, 3 1/4"



CASTROVIEJO

05-1143.11

11 cm, 4 1/4"



CASTROVIEJO

05-1145.11

11 cm, 4 1/4"



CASTROVIEJO

05-1147.11

11 cm, 4 1/4"

05

Augen- und Mikroscheren
Ophthalmic and Micro Scissors
Ciseaux oculaires et pour microchirurgie
Tijeras para oftalmología y microcirugía

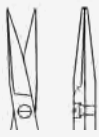

05-1152.18

18 cm, 7"



05-1153.18

18 cm, 7"

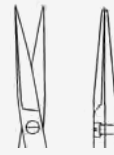

05-1156.18

18 cm, 7"

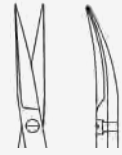

05-1157.18

18 cm, 7"

Chapter 06

Table of Contents

Pinzetten / **p.66 - 78**

Dressing and Tissue Forceps / **p. 66 - 78**

Pinces à dissection / **p. 66 - 78**

Pinzas de disección / **p. 66 - 78**





06

Anatomische Pinzetten
Dissecting Forceps
 Pincés à dissection
 Pinzas de disección



06-0200.10	10,5 cm, 4 1/2"
06-0200.11	11,5 cm, 4 1/2"
06-0200.13	13 cm, 5"
06-0200.14	14,5 cm, 5 1/2"
06-0200.16	16 cm, 6 1/4"
06-0200.18	18 cm, 7"
06-0200.20	20 cm, 8"
06-0200.25	25 cm, 10"
06-0200.30	30 cm, 12"



06-0208.11	11,5 cm, 4 1/2"
06-0208.13	13 cm, 5"
06-0208.14	14,5 cm, 5 1/2"
06-0208.16	16 cm, 6 1/4"
06-0208.18	18 cm, 7"
06-0208.20	20 cm, 8"
06-0208.25	25 cm, 10"
06-0208.30	30 cm, 12"



USA-MODELL	
06-0312.12	12 cm, 4 3/4"
06-0312.13	13 cm, 5"
06-0312.14	14,5 cm, 5 1/2"
06-0312.15	15,5 cm, 6"
06-0312.18	18 cm, 7"
06-0312.21	21 cm, 8 1/4"
06-0312.25	25 cm, 10"



STILLE	
06-0320.15	15 cm, 5 3/4"
06-0320.17	17 cm, 6 3/4"

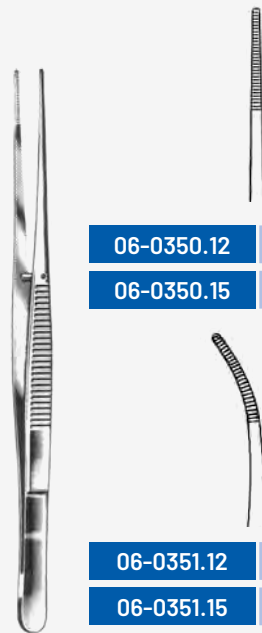

SEMKEN

06-0350.12	12,5 cm, 5"
06-0350.15	15 cm, 5 3/4"
06-0351.12	12,5 cm, 5"
06-0351.15	15 cm, 5 3/4"



MC INDOE	
06-0360.15	15 cm, 5 3/4"



GERALD
06-0370.18
18 cm, 7"



GERALD
06-0371.18
18 cm, 7"



GERALD
06-0373.18
18 cm, 7"



CUSHING
06-0390.17
17 cm, 6 3/4"



ADSON	
06-0380.12	12 cm, 4 3/4"
06-0380.15	15 cm, 5 3/4"



ADSON-MICRO	
06-0386.12	12 cm, 4 3/4"



POTTS-SMITH	
06-0420.18	18 cm, 7"
06-0420.21	21 cm, 8 1/4"
06-0420.25	25 cm, 10"

06

Pinzetten mit Hartmetalleinlagen
Forceps with Tungsten Carbide Inserts
Pincés à dissection avec mors en tungstène
Pinzas de disección con bocas de carburo de tungsteno



06-0212.14	14,5 cm, 5 1/2"
06-0212.16	16 cm, 6 1/4"



ADSON	
06-0384.12	12 cm, 4 3/4"
06-0384.15	15 cm, 5 3/4"



POTTS-SMITH	
06-0424.18	18 cm, 7"
06-0424.21	21 cm, 8 1/4"
06-0424.25	25 cm, 10"



06-1200.10	10,5 cm, 4 3/4"
06-1200.11	11,5 cm, 4 1/2"
06-1200.13	13 cm, 5"
06-1200.14	14,5 cm, 5 1/2"
06-1200.16	16 cm, 6 1/4"
06-1200.18	18 cm, 7"
06-1200.20	20 cm, 8"
06-1200.25	25 cm, 10"
06-1200.30	30 cm, 12"



06-1208.11	11,5 cm, 4 1/2"
06-1208.13	13 cm, 5"
06-1208.14	14,5 cm, 5 1/2"
06-1208.16	18 cm, 6 1/4"
06-1208.18	16 cm, 7"
06-1208.20	20 cm, 8"
06-1208.25	25 cm, 10"



USA-MODELL	
06-1312.12	12 cm, 4 3/4"
06-1312.13	13 cm, 5"
06-1312.14	14,5 cm, 5 1/2"
06-1312.15	15,5 cm, 6"
06-1312.18	18 cm, 7"
06-1312.21	21 cm, 8 1/4"
06-1312.25	25 cm, 10"



06-1223.13	13 cm, 5"
06-1223.14	14,5 cm, 5 1/2"
06-1223.16	16 cm, 6 1/4"
06-1223.18	18 cm, 7"
06-1223.20	20 cm, 8"
06-1223.25	25 cm, 10"



06-1234.13	13 cm, 5"
06-1234.14	14,5 cm, 5 1/2"
06-1234.16	16 cm, 6 1/4"



06-1245.13	13 cm, 5"
06-1245.14	14,5 cm, 5 1/2"
06-1245.16	16 cm, 6 1/4"

06

Chirurgische Pinzetten
Tissue Forceps
 Pincas quirúrgicas
 Pinzas quirúrgicas



1 x 2

STILLE

06-1320.15

15 cm, 5 3/4"



1 x 2

LANE

06-1332.14

14,5 cm, 5 1/2"



2 x 3

LANE

06-1334.14

14,5 cm, 5 1/2"



1 x 2

GILLIES

06-1366.15

15,5 cm, 6"

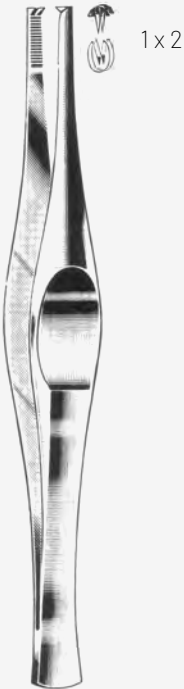

1 x 2

FERRIS-SMITH

06-1342.18

18 cm, 7"

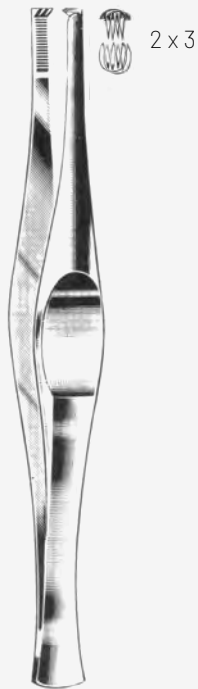

2 x 3

FERRIS-SMITH

06-1344.18

18 cm, 7"



1 x 2

SEMKEN

06-1350.12

12,5 cm, 5"

06-1350.15

15 cm, 5 3/4"

06-1351.12

12,5 cm, 5"

06-1351.15

15 cm, 5 3/4"



GERALD
06-1370.18
18 cm, 7"

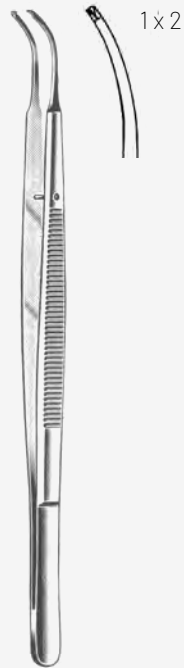

GERALD
06-1371.18
18 cm, 7"



GERALD
06-1373.18
18 cm, 7"



CUSHING
06-1390.17
17 cm, 6 3/4"



ADSON	
06-1380.12	12 cm, 4 3/4"
06-1380.15	15 cm, 5 3/4"



ADSON-MICRO	
06-1386.12	12 cm, 4 3/4"



POTTS-SMITH	
06-1420.18	18 cm, 7"
06-1420.21	21 cm, 8 1/4"
06-1420.25	25 cm, 10"

06

Faßpinzetten
Grasping Forceps
 Pincés pour saisir les tissus
 Pinzas para agarrar



GRAEFE

06-5020.10

10,5 cm, 4"



LERCHE

06-5146.15

15 cm, 5 3/4"



ADLERKREUTZ

06-5110.15

15 cm, 5 3/4"

06-5110.20

20 cm, 8"



RUSS. MODELL

06-5210.15

15 cm, 5 3/4"

06-5210.20

20 cm, 8"

06-5210.25

25 cm, 10"

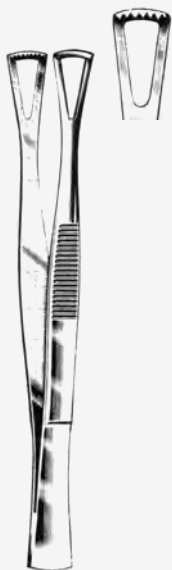

DUVAL

06-5314.07

14,5 cm, 5 1/2"



DUVAL-COLLIN

06-5320.20

20 cm, 8"



BROWN-ADSON

06-5340.12

12 cm, 4 3/4"



BROWN

06-5344.16

16 cm, 6 1/4"

06-5344.20

20 cm, 8"

06-5344.25

25 cm, 10"



SINGLEY

06-5260.23

23 cm, 9"



NELSON

06-5270.23

23 cm, 9"



WANGENSTEEN

06-5330.23

23 cm, 9"

06

Splitterpinzetten
Splinter Forceps
 Pincas à écharde
 Pinzas para espinas

No. 3



MOD SWITZERLAND

06-5862.11

11,5 cm, 4 1/4"

No. 4



MOD SWITZERLAND

06-5864.11

11,5 cm, 4 1/4"

No. 5



MOD SWITZERLAND

06-5866.11

11,5 cm, 4 1/4"

No. 7



MOD SWITZERLAND

06-5867.11

11,5 cm, 4 1/4"



06-5920.09

9 cm, 3 1/2"

06-5920.11

11 cm, 4 1/4"



FEILCHENFELD

06-5902.07 7 cm, 2 3/4"

06-5902.09 9 cm, 3 1/2"

06-5902.11 11,5 cm, 4 1/2"



06-5907.10

10,5 cm, 4"



06-5906.10

10,5 cm, 4"



06-5909.10

10,5 cm, 4"



06-5908.10

10,5 cm, 4"



CARMALT



PEET
06-5935.11
11,5 cm, 4 1/4"



STIEGLITZ



06-5932.13
13,5 cm, 5 1/4"

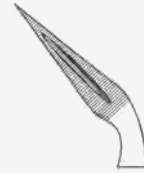

06-5933.13
13,5 cm, 5 1/4"

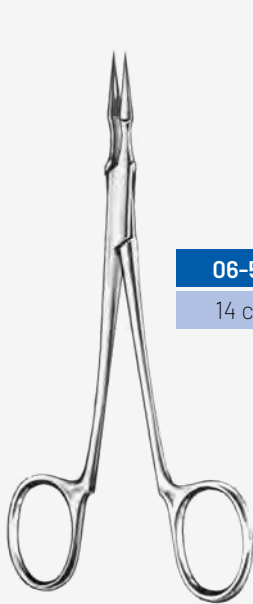

ARCHER



06-5934.14
14 cm, 5 1/2"

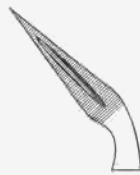

06-5935.14
14 cm, 5 1/2"



RALK
06-5938.15
15 cm, 5 3/4"

06

Pinzetten für die Mikrochirurgie, Atraumatische Pinzetten
Microsurgery Forceps, Atraumatic Forceps
 Pincés à microchirurgie, Pincés atraumáticos
 Pinzas para microcirugía, Pinzas atraumáticas



06-7022.12	12 cm, 4 3/4"
06-7022.15	15 cm, 5 3/4"
06-7022.18	18 cm, 7"



06-7023.12	12 cm, 4 3/4"
06-7023.15	15 cm, 5 3/4"
06-7023.18	18 cm, 7"



2,0 mm



06-8032.16	16 cm, 6 1/4"
06-8032.20	20 cm, 8"

COOLEY



1,5 mm



06-8016.16	16 cm, 6 1/4"
06-8016.20	20 cm, 8"
06-8016.24	24 cm, 9 1/2"

2,0 mm



06-8028.16	16 cm, 6 1/4"
06-8028.20	20 cm, 8"
06-8028.24	24 cm, 9 1/2"
06-8028.30	30 cm, 12"

2,0 mm



06-8029.16	16 cm, 6 1/4"
06-8029.20	20 cm, 8"
06-8029.24	24 cm, 9 1/2"
06-8029.30	30 cm, 12"

2,7 mm



06-8014.16	16 cm, 6 1/4"
06-8014.20	20 cm, 8"
06-8014.24	24 cm, 9 1/2"
06-8014.30	30 cm, 12"

3,5 mm



06-8030.16	16 cm, 6 1/4"
06-8030.20	20 cm, 8"
06-8030.24	24 cm, 9 1/2"
06-8030.30	30 cm, 12"

DE BAKEY

Chapter 07

Table of Contents

Arterienklemmen / **p. 80 - 110**

Haemostatic Forceps / **p. 80 - 110**

Pinces hémostatiques / **p. 80 - 110**

Pinzas hemostáticas / **p. 80 - 110**





07

Arterienklemmen
Hemostatic Forceps
 Pincas hémostatiques
 Pinzas hemostáticas



DE BAKEY



07-0070.07

7,5 cm, 3"



07-0070.08

8,5 cm, 3 1/2"



07-0070.10

10,5 cm, 4"



07-0070.12

12 cm, 4 3/4"



07-0071.07

7,5 cm, 3"



07-0071.08

8,5 cm, 3 1/2"



07-0071.10

10,5 cm, 4"

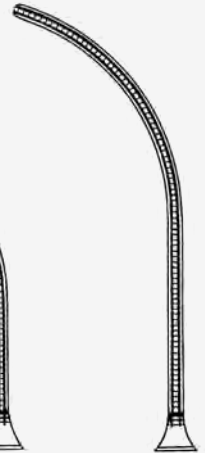

07-0071.12

12 cm, 4 3/4"



GLOVER



07-0150.06

6 cm, 2 1/2"



07-0150.07

7 cm, 2 3/4"



07-0150.09

9 cm, 3 1/2"



07-0150.11

11 cm, 4 1/4"



07-0151.06

5,5 cm, 2 1/4"



07-0151.07

6,5 cm, 2 3/4"



07-0151.09

8,5 cm, 3 1/2"



07-0151.11

10,5 cm, 4"



07-0160.04

3,5 cm, 1 1/2"



07-0160.05

5,5 cm, 2 1/4"



07-0161.04

3,5 cm, 1 1/2"



07-0161.05

5,5 cm, 2 1/4"



DIEFFENBACH



07-0170.50

5 cm, 2"



07-0170.55

5,5 cm, 2 1/4"



07-0170.65

6,5 cm, 2 3/4"



07-0170.70

7 cm, 3"



07-0170.75

7,5 cm, 3 1/4"



07-0170.90

9 cm, 3 1/2"



07-0171.50

5 cm, 2"



07-0171.55

5,5 cm, 2 1/4"



07-0171.65

6,5 cm, 2 3/4"



07-0171.70

7 cm, 3"



07-0171.75

7,5 cm, 3 1/4"



07-0171.90

9 cm, 3 1/2"



JOHNS-HOPKINS

07

Arterienklemmen
Hemostatic Forceps
Pinces hémostatiques
Pinzas hemostáticas



07-0520.10

10 cm, 4"



07-0521.10

10 cm, 4"

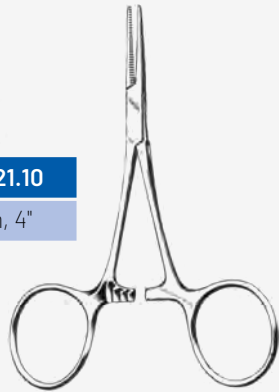

HARTMANN



07-0522.10

10 cm, 4"



07-0523.10

10 cm, 4"

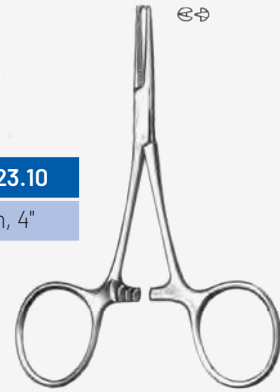

HARTMANN



07-0600.12

12,5 cm, 5"



07-0601.12

12,5 cm, 5"



MICRO-MOSQUITO



07-0602.12

12,5 cm, 5"



07-0603.12

12,5 cm, 5"

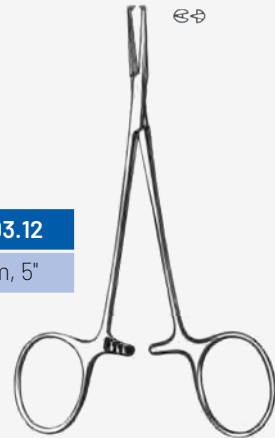

MICRO-MOSQUITO



HALSTEAD-MOSQUITO

07-0620.12	12,5 cm, 5"
07-0620.14	14 cm, 5 1/2"
07-0620.18	18 cm, 7"
07-0620.21	21 cm, 8 1/4"



HALSTEAD-MOSQUITO

07-0621.12	12,5 cm, 5"
07-0621.14	14 cm, 5 1/2"
07-0621.18	18 cm, 7"
07-0621.21	21 cm, 8 1/4"



HALSTEAD-MOSQUITO

07-0622.12	12,5 cm, 5"
07-0622.14	14 cm, 5 1/2"
07-0622.18	18 cm, 7"
07-0622.21	21 cm, 8 1/4"



HALSTEAD-MOSQUITO

07-0623.12	12,5 cm, 5"
07-0623.14	14 cm, 5 1/2"
07-0623.18	18 cm, 7"
07-0623.21	21 cm, 8 1/4"

07

Arterienklemmen
Hemostatic Forceps
Pinces hémostatiques
Pinzas hemostáticas



07-0800.14

14 cm, 5 1/2"



07-0801.14

14 cm, 5 1/2"



KELLY



07-0802.16

16 cm, 6 1/2"



07-0803.16

16 cm, 6 1/2"



KELLY-RANKIN



07-0820.14

14 cm, 5 1/2"



07-0821.14

14 cm, 5 1/2"

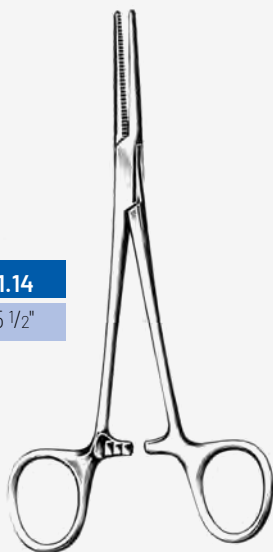

CRILE



07-0822.14

14 cm, 5 1/2"



07-0823.14

14 cm, 5 1/2"



CRILE



07-0826.16

16 cm, 6 1/2"



07-0827.16

16 cm, 6 1/2"



CRILE-RANKIN



07-0828.16

16 cm, 6 1/2"



07-0829.16

16 cm, 6 1/2"

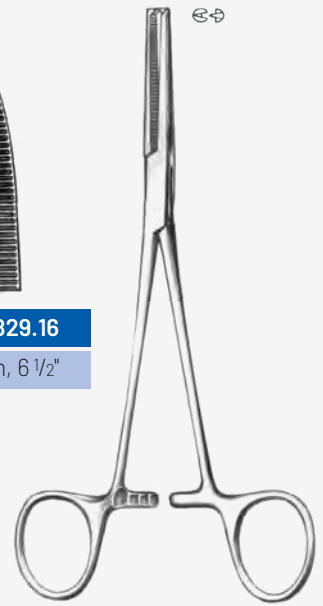

CRILE-RANKIN



07-0726.14

14 cm, 5 1/2"



07-0727.14

14 cm, 5 1/2"



PROVIDENCE-HOSPITAL



07-0930.14

14 cm, 5 1/2"



07-0931.14

14 cm, 5 1/2"



PEAN

07

Arterienklemmen
Hemostatic Forceps
Pincas hémostatiques
Pinzas hemostáticas



07-0940.13

13 cm, 5"



07-0940.14

14 cm, 5 1/2"



07-0940.16

16 cm, 6 1/2"



07-0940.18

18 cm, 7"



07-0940.20

20 cm, 8"



07-0940.22

22 cm, 8 1/2"



07-0940.24

24 cm, 9 1/2"



07-0940.26

26 cm, 10 1/4"



07-0940.28

28 cm, 11"



07-0940.30

30 cm, 12"



ROCHESTER-PEAN

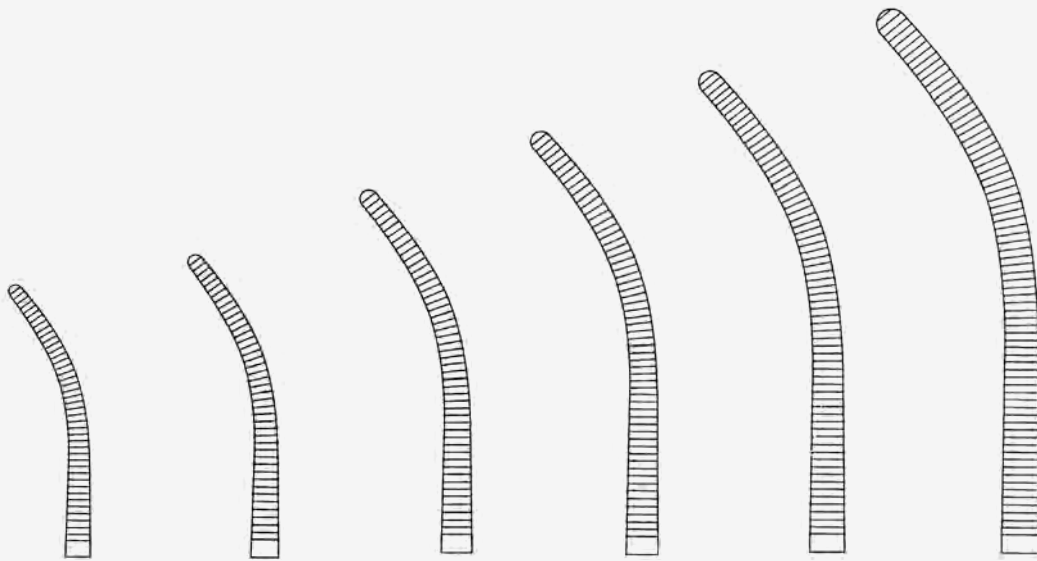

07-0941.13	07-0941.14	07-0941.16	07-0941.18	07-0941.20	07-0941.22
13 cm, 5"	14 cm, 5 1/2"	16 cm, 6 1/2"	18 cm, 7"	20 cm, 8"	22 cm, 8 1/2"

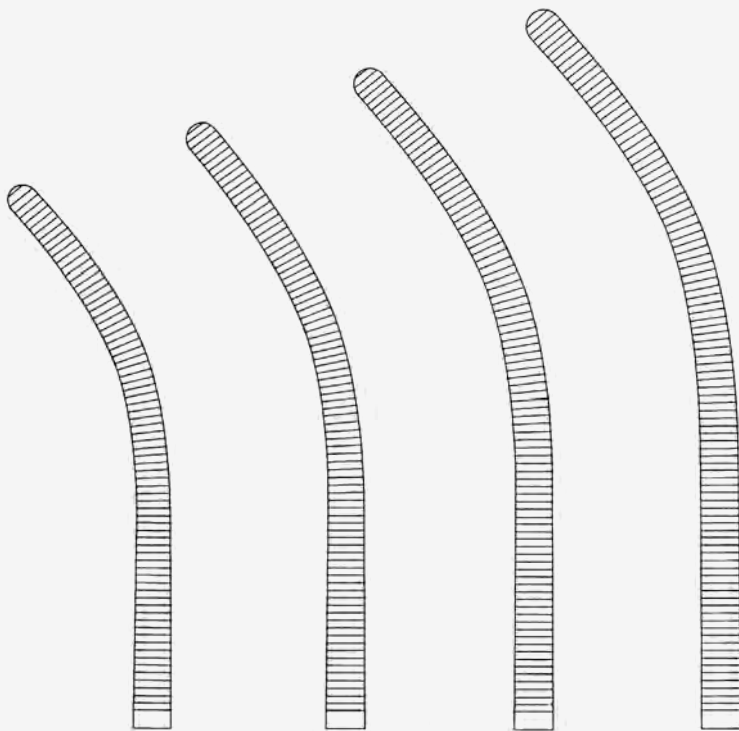

07-0941.24	07-0941.26	07-0941.28	07-0941.30
24 cm, 9 1/2"	26 cm, 10 1/4"	28 cm, 11"	30 cm, 12"



ROCHESTER-PEAN

07

Arterienklemmen
Hemostatic Forceps
 Pinces hémostatiques
 Pinzas hemostáticas



07-1030.13
 13 cm, 5"



07-1030.14
 14 cm, 5 1/2"



07-1030.16
 16 cm, 6 1/2"

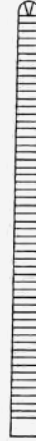

07-1030.18
 18 cm, 7"



07-1030.20
 20 cm, 8"



07-1030.22
 22 cm, 8 1/2"



07-1030.24
 24 cm, 9 1/2"



07-1030.26
 26 cm, 10 1/4"



07-1030.28
 28 cm, 11"



07-1030.30
 30 cm, 12"



ROCHESTER-UCHSNER

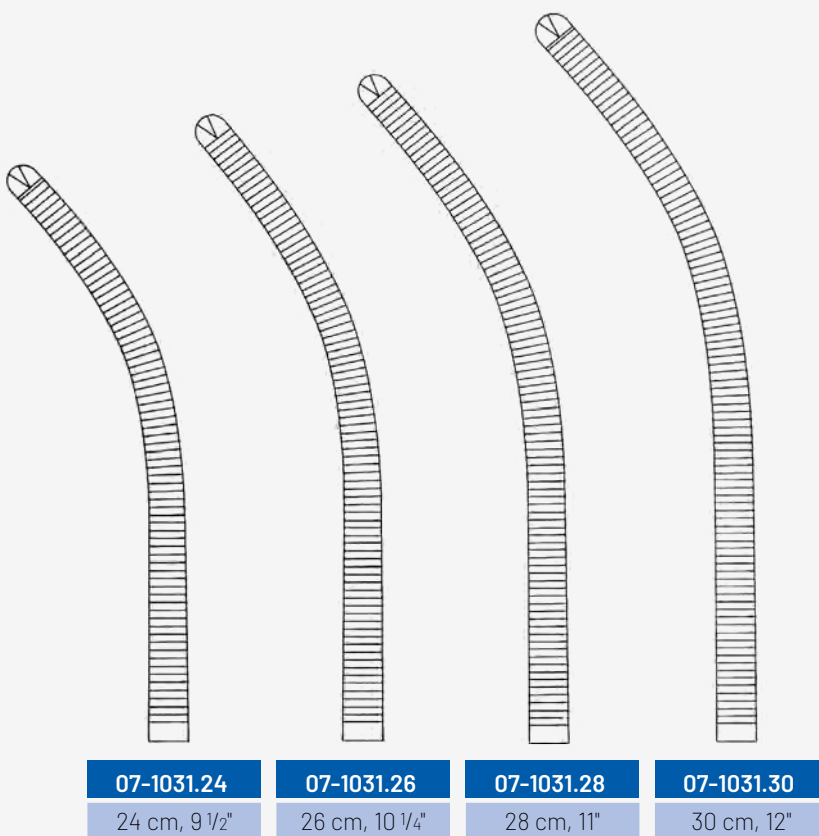
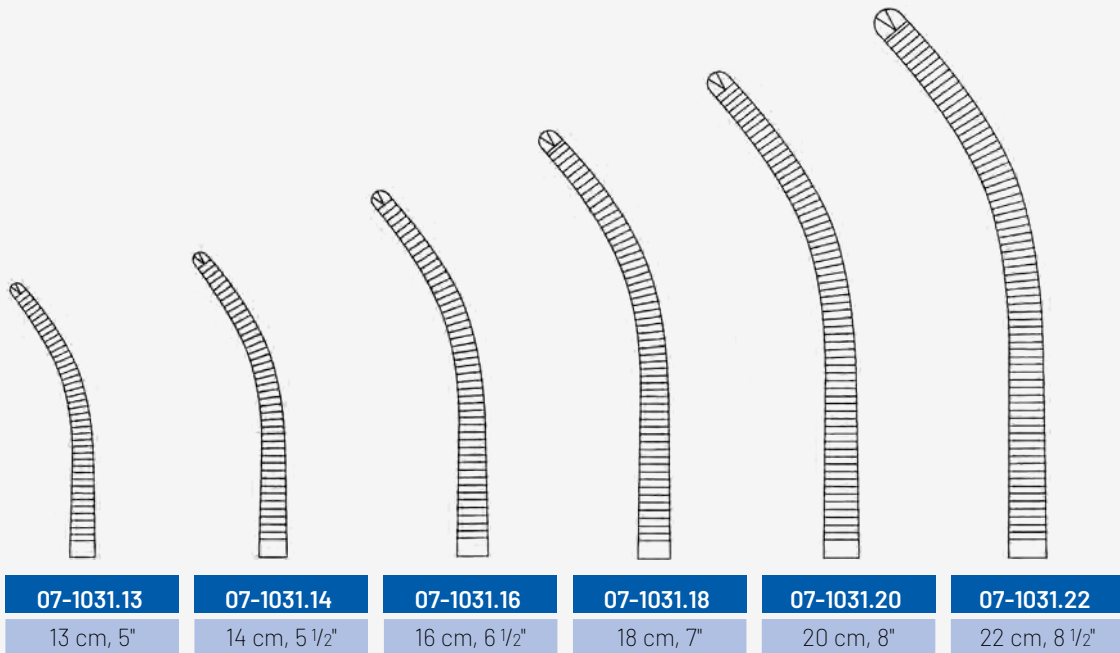

ROCHESTER-OCHSNER

07

Arterienklemmen
Hemostatic Forceps
Pincas hémostatiques
Pinzas hemostáticas



07-1028.14

14 cm, 5 1/2"



07-1029.14

14 cm, 5 1/2"



KOCHER



07-1050.14

14 cm, 5 1/2"



07-1051.14

14 cm, 5 1/2"



SPENCER-WELLS



07-0860.16

16 cm, 6 1/2"



07-0861.16

16 cm, 6 1/2"



07-0860.20

20 cm, 8"



07-0861.20

20 cm, 8"

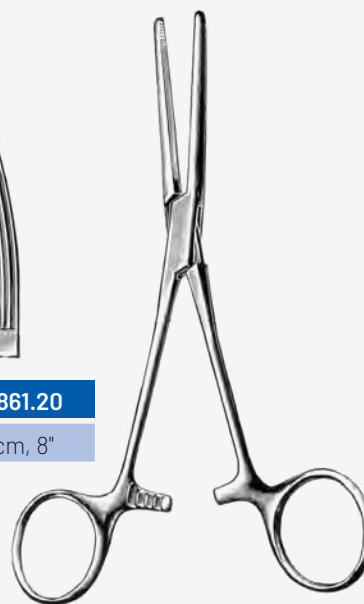

ROCHESTER-CARMALT

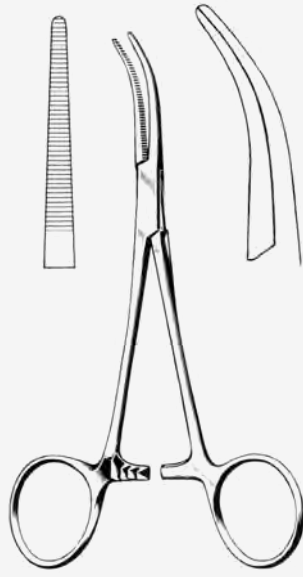

DANDY
07-0671.14
 14 cm, 5 1/2"

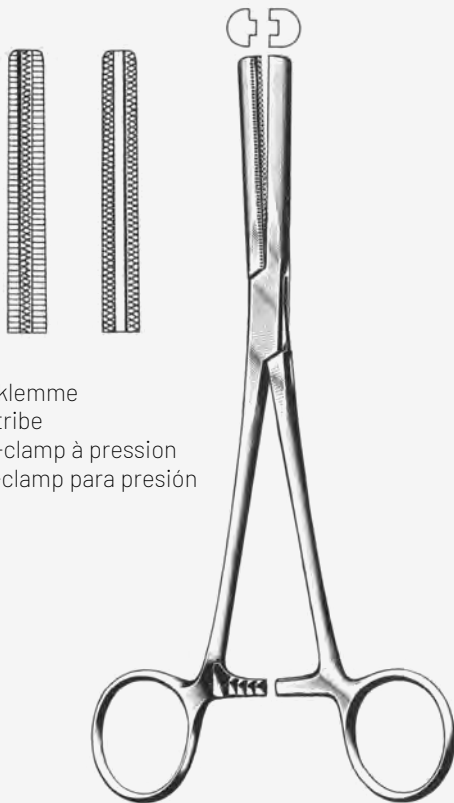

Druckklemme
 Angiotribe
 Pince-clamp à pression
 Pinza-clamp para presión

FERGUSON
07-4524.16
 16 cm, 6 1/2"



Druckklemme
 Angiotribe
 Pince-clamp à pression
 Pinza-clamp para presión

FERGUSON
07-4525.16
 16 cm, 6 1/2"

07

Arterienklemmen, Gewebefäßzangen

Hemostatic Forceps, Intestinal Tissue Forceps

Pinces hémostatiques, Pinces pour saisir le tissu

Pinzas hemostáticas, Pinzas para coger tejidos

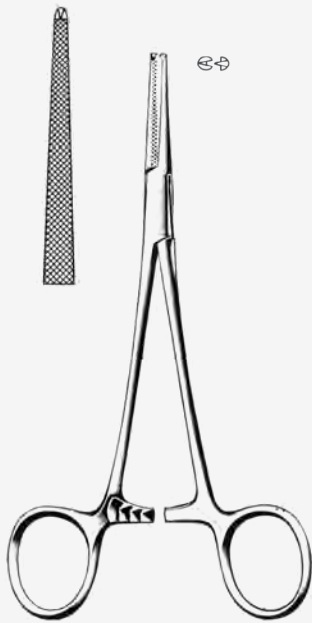

LOVELACE

07-4377.15

15,5 cm, 6"



PENNINGTON

07-4372.15

15 cm, 5 3/4"



PRATT

07-4504.15

15 cm, 5 3/4"



DeMARTEL

07-4501.14

14 cm, 5 1/2"



WILLET-MARTEL

07-4501.19

19 cm, 7 1/2"

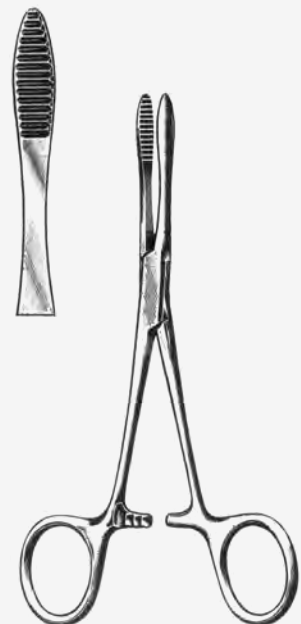

PEAN

07-0920.14

14 cm, 5 1/2"

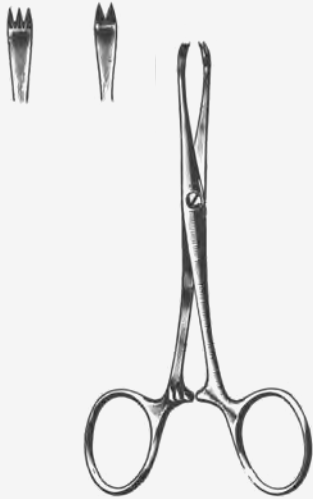

CHAPUT

07-4312.13

13 cm, 5"



TUFFIER

07-4310.13

13 cm, 5"



COLLIN

07-4350.14

14 cm, 5 1/2"



COLLIN

07-4542.16

16 cm, 6 1/2"

07

Arterienklemmen
Hemostatic Forceps
Pincas hémostatiques
Pinzas hemostáticas



07-0710.15

15 cm, 5 3/4"



07-0711.15

15 cm, 5 3/4"



LERICHE



07-0712.15

15 cm, 5 3/4"



07-0713.15

15 cm, 5 3/4"



LERICHE



07-0774.20

20 cm, 8"



07-0775.20

20 cm, 8"



BENGOLEA



07-0776.20

20 cm, 8"



07-0777.20

20 cm, 8"

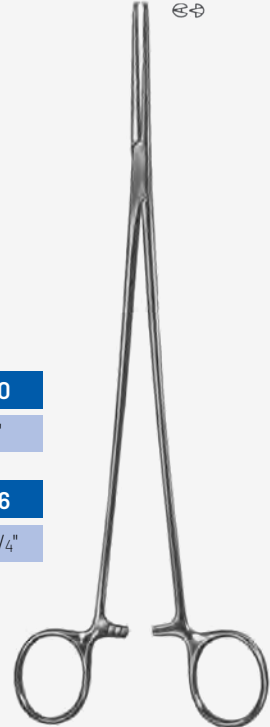

BENGOLEA



07-0730.20

20 cm, 8"



07-0731.20

20 cm, 8"



07-0733.20

20 cm, 8"



HEISS



07-0650.19

19 cm, 7 1/2"



07-0651.19

19 cm, 7 1/2"



ADSON



07-0652.19

19 cm, 7 1/2"

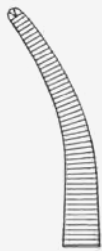

07-0653.19

19 cm, 7 1/2"

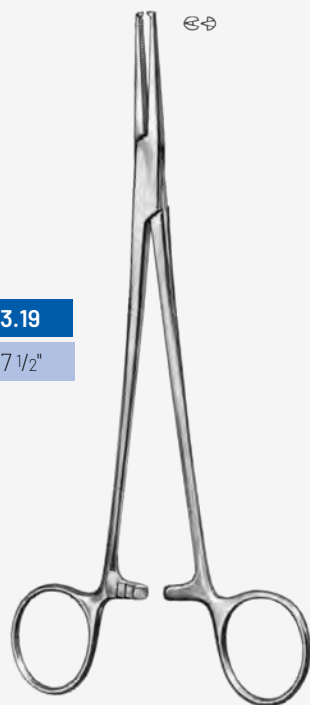

ADSON



ADSON-BABY

07-0655.18

18,5 cm, 7 1/4"

07

Präparier- und Ligaturklemmen
Dissecting and Ligature Forceps
 Pincès à dissection et à ligatures
 Pinzas para disección y ligaduras

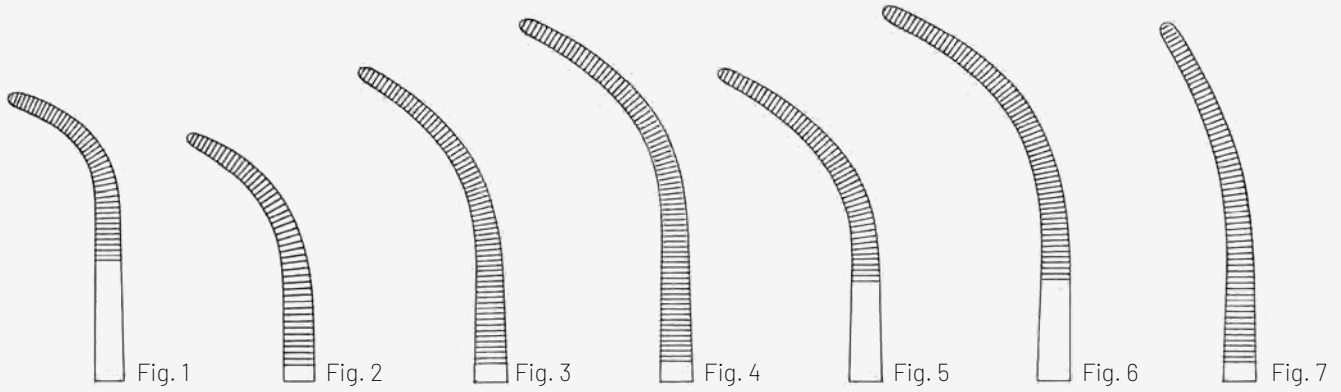

07-1711.01	07-1711.02	07-1711.03	07-1711.04	07-1711.05	07-1711.06	07-1711.07
21 cm, 8 1/4"	21 cm, 8 1/4"	21 cm, 8 1/4"	21 cm, 8 1/4"	21 cm, 8 1/4"	21 cm, 8 1/4"	21 cm, 8 1/4"
07-1713.01	07-1713.02	07-1713.03	07-1713.04	07-1713.05	07-1713.06	07-1713.07
27 cm, 10 1/2"	27 cm, 10 1/2"	27 cm, 10 1/2"	27 cm, 10 1/2"	27 cm, 10 1/2"	27 cm, 10 1/2"	27 cm, 10 1/2"



OVERHOLT-GEISSENDOERFER



07-1743.13

13 cm, 5"



07-1743.16

16 cm, 6 1/4"



07-1743.18

18 cm, 7"



07-1743.20

20 cm, 8"



07-1743.23

23 cm, 9"



07-1743.25

25 cm, 10"



07-1743.28

28 cm, 11"

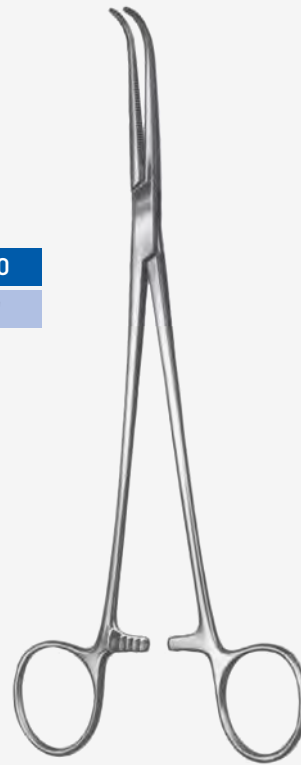

GEMINI



07-1745.18

18 cm, 7"

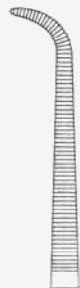

07-1745.22

22 cm, 8 1/2"



07-1745.25

25 cm, 10"



07-1745.28

28 cm, 11"



GEMINI (MIXTER)

07

Präparier- und Ligaturklemmen
Dissecting and Ligature Forceps
Pincès à dissection et à ligatures
Pinzas para disección y ligaduras

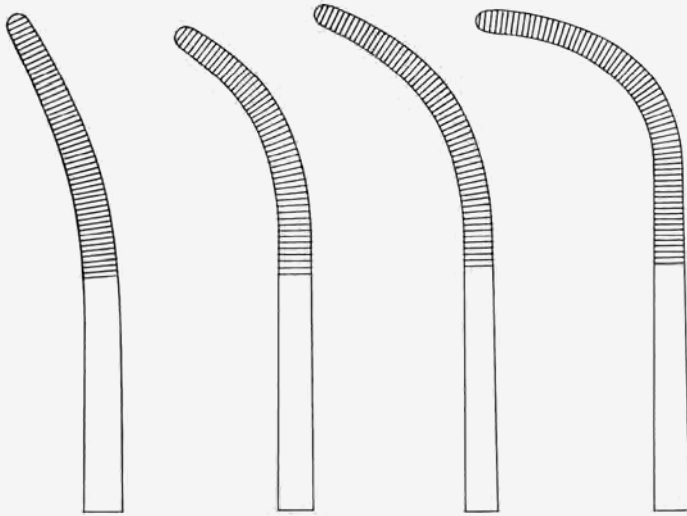

07-1701.01
23 cm, 9"

07-1701.02
23 cm, 9"

07-1701.03
23 cm, 9"

07-1701.04
23 cm, 9"

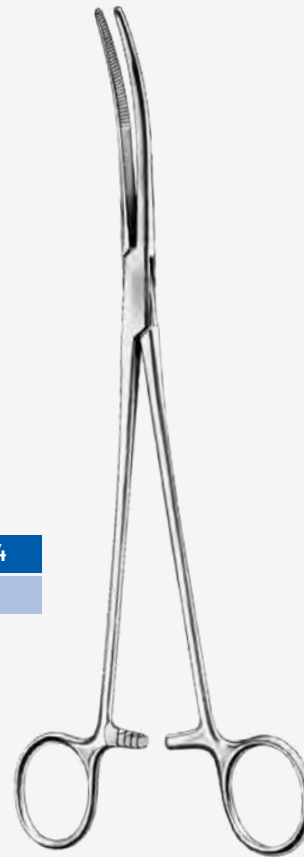

RUMMEL

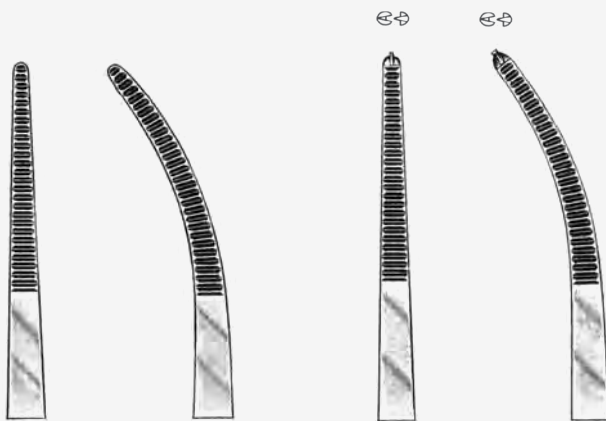

07-1080.21
21 cm, 8 1/4"

07-1081.21
21 cm, 8 1/4"

07-1082.21
21 cm, 8 1/4"

07-1083.21
21 cm, 8 1/4"

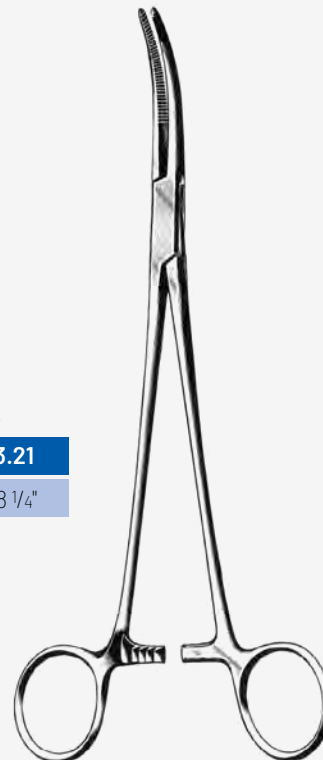

TOENNIS



07-1070.22

22 cm, 8 1/2"



07-1071.22

22 cm, 8 1/2"

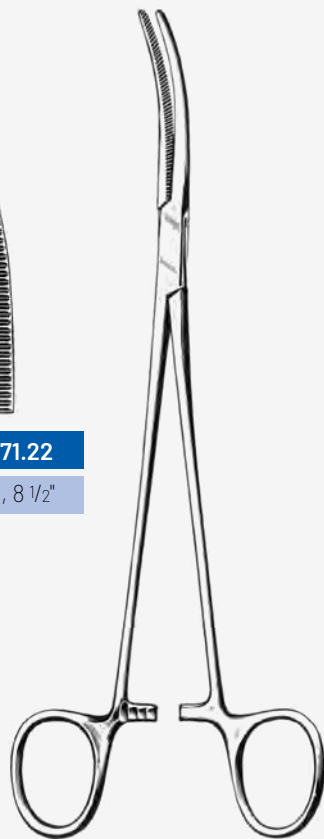

ROBERTS



07-1066.24

24 cm, 9 1/2"



07-1067.24

24 cm, 9 1/2"

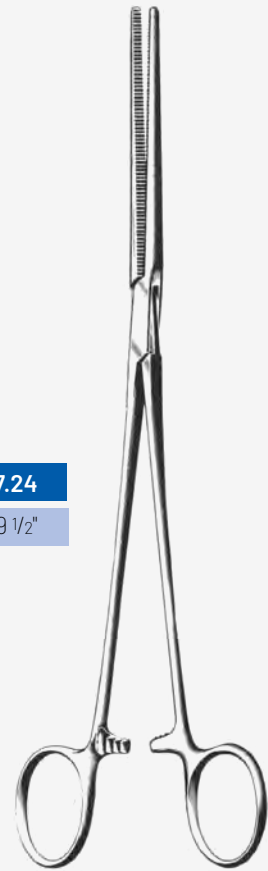

SAROT

07

Präparier- und Ligaturklemmen
Dissecting and Ligature Forceps
Pinces à dissection et à ligatures
Pinzas para disección y ligaduras



CRAFOORD
07-0751.24
24 cm, 9 1/2"

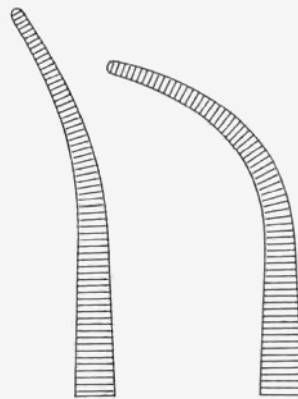

07-1059.01 **07-1059.02**
29,5 cm, 11 1/2" 29,5 cm, 11 1/2"



ZENKER



LAWRENCE

07-1115.28

28 cm, 11"



MEEKER

07-1109.28

28 cm, 11"



MIXTER

07-1573.22

22 cm, 8 1/2"

07

Arterien-, Gallenkanal-, Nierenstielklemmen
Hemostatic, Gall Duct and Kidney Pedicle Forceps
 Pincas hémostatiques, pédicule renal et voies biliares
 Pinzas hemostáticas, pedículo renal y vías biliares



MIXTER

07-1583.14	14 cm, 5 1/2"
07-1583.16	16 cm, 6 1/4"
07-1583.18	18 cm, 7"
07-1583.23	23 cm, 10"



MIXTER-BABY

07-1521.14	14 cm, 5 1/2"
-------------------	---------------



MIXTER-BABY

07-1521.18	18 cm, 7"
-------------------	-----------



MIXTER-O'SHAUGHNESSY

07-1523.15	07-1523.18
15,5 cm, 6"	18 cm, 7"



07-1563.22	07-1563.25	07-1563.28
22 cm, 8 1/2"	25 cm, 10"	28 cm, 11"



MIXTER

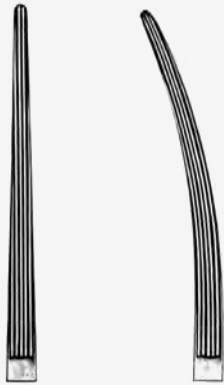

07-0840.15

15 cm, 5 3/4"



07-0841.15

15 cm, 5 3/4"

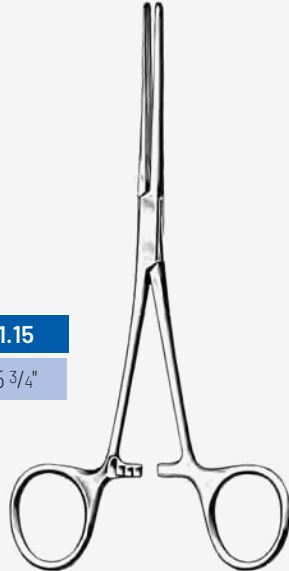

BAINBRIDGE



LAHEY

07-1551.19

19 cm, 7 1/2"



LAHEY

07-1551.23

23 cm, 9"

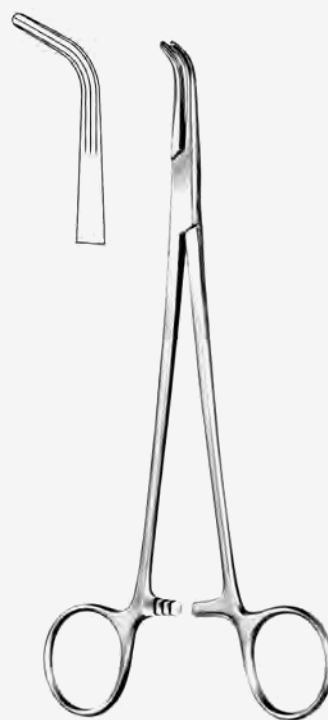

LOWER

07-4825.18

18 cm, 7"



JOHNS-HOPKINS

07-1559.20

20 cm, 8"

07

Arterien-, Gallenkanal-, Nierenstielklemmen
Hemostatic, Gall Duct and Kidney Pedicle Forceps
 Pincès hémostatiques, pédicule renal et voies biliaires
 Pinzas hemostáticas, pedículo renal y vías biliaires



DESJARDINS
07-4837.21
 21 cm, 8 1/4"



DESJARDINS
07-4841.21
 21 cm, 8 1/4"



MIXTER
07-1539.26
 16,5 cm, 6 1/2"



MOYNIHAN
07-4865.23
 23 cm, 9"

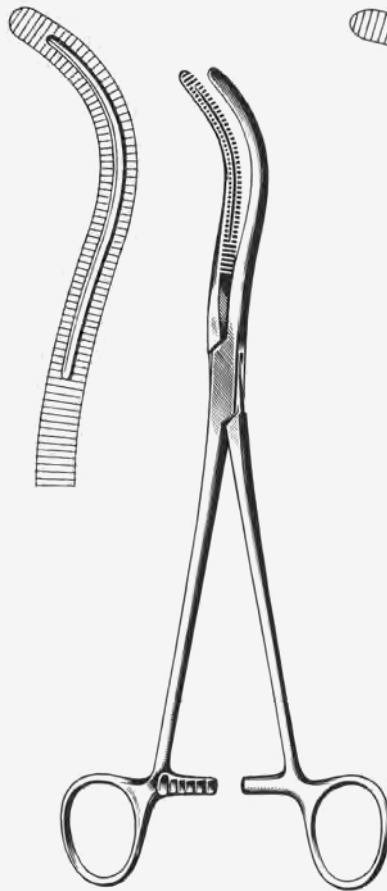

STILLE
07-4601.23
 23 cm, 9"

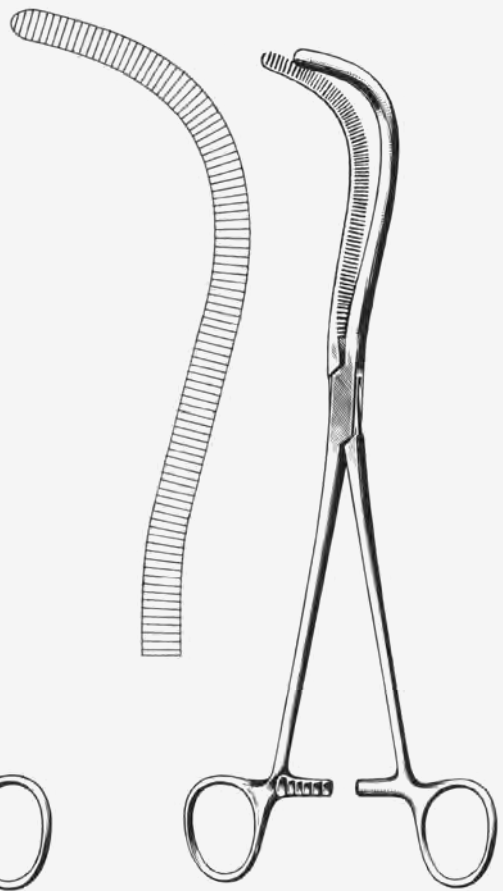

MAYO-GUYON
07-4627.23
 23 cm, 9"



GUYON
07-4626.23
 23 cm, 9"

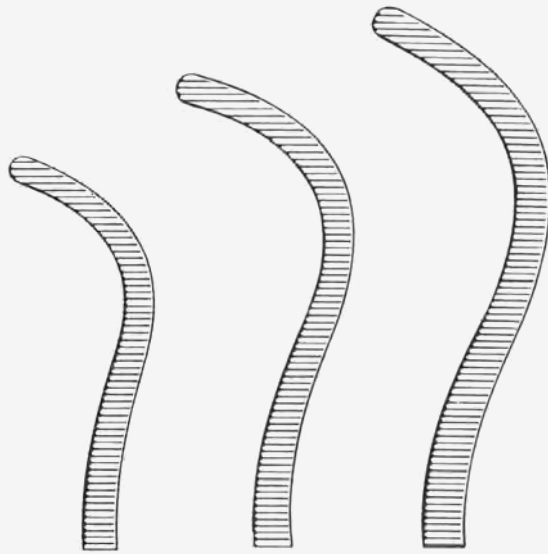

07-4623.20
 20 cm, 8"

07-4623.22
 22 cm, 8 1/2"

07-4623.24
 24 cm, 9 1/2"

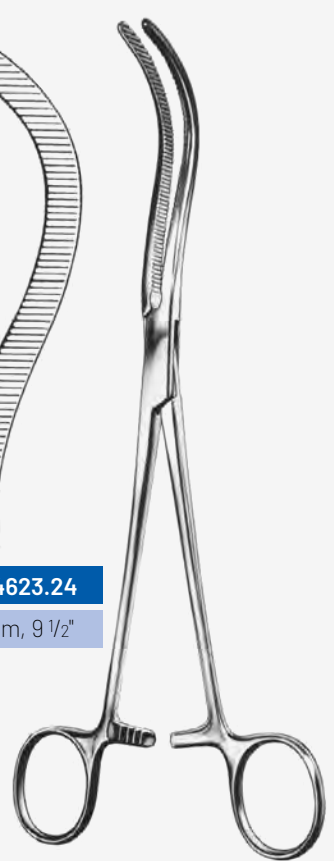

GUYON

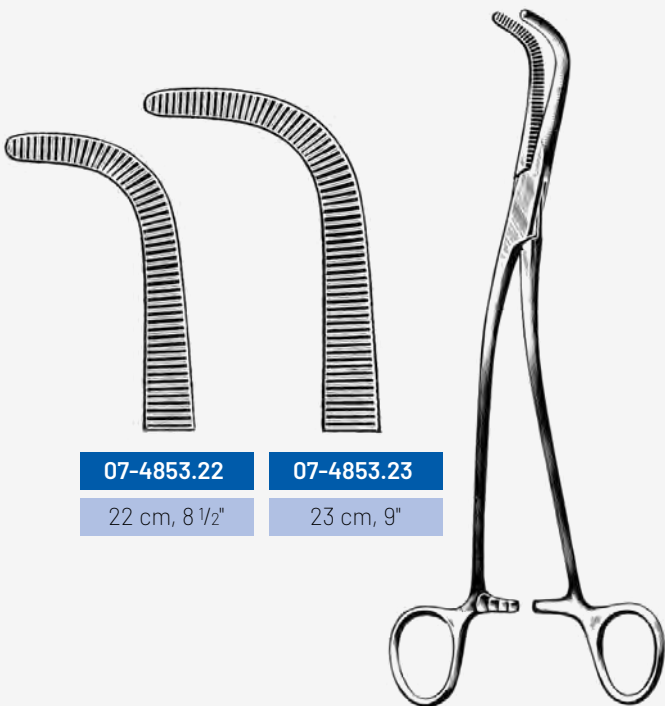

07-4853.22
 22 cm, 8 1/2"

07-4853.23
 23 cm, 9"

GRAY

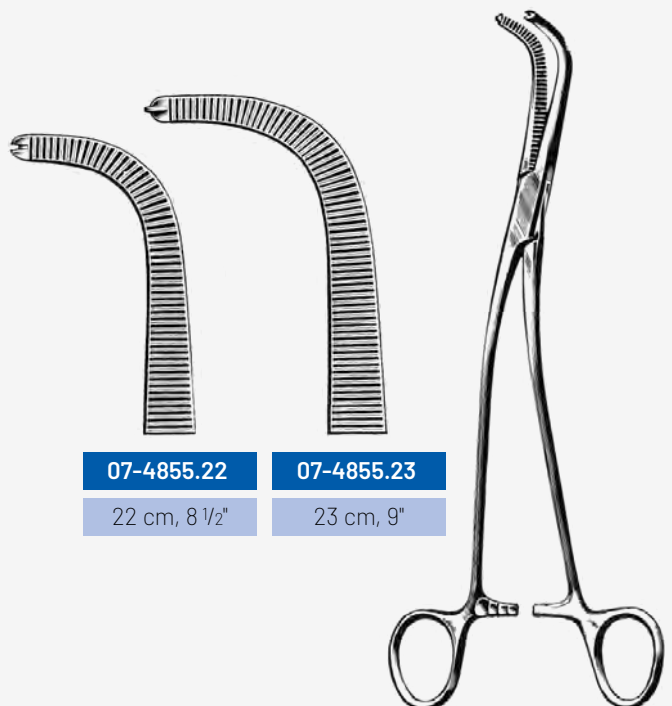

07-4855.22
 22 cm, 8 1/2"

07-4855.23
 23 cm, 9"

GRAY

07

Nierenstielklemmen, Peritoneumklemmen, Hyterektomieklemmen

Kidney Pedicle Forceps, Peritoneum Forceps, Hyterectomy Forceps

Clamps rénaux, Pincas-clamps pour le péritoine, Pincas à hystérectomie

Pinzas-clamps renales, Pinzas-clamps para peritoneo, Pinzas-clamps para histerectomía



HERRICK

07-4621.23

23 cm, 9"



WERTHEIM-CULLEN

07-6127.21

21,5 cm, 8 1/4"

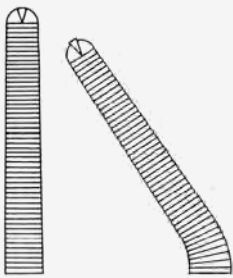

07-6100.21

21 cm, 8 1/4"

07-6101.21

21 cm, 8 1/4"

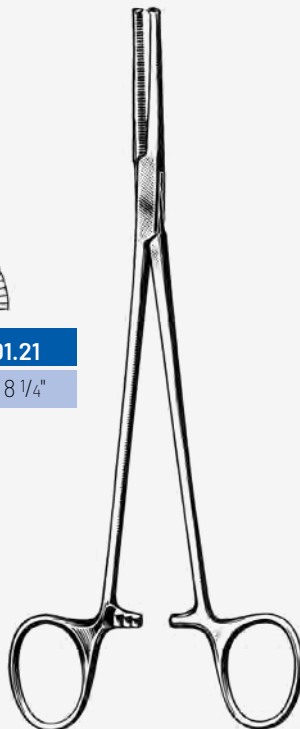

PHANEUF



07-6135.23

23 cm, 9"

07-6136.23

23 cm, 9"



WERTHEIM

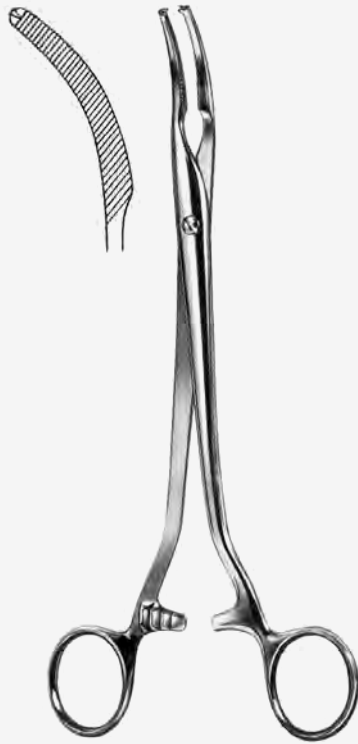

MICULICZ
07-6223.20
 20 cm, 8"



07-6243.20
 20 cm, 8"

07-6245.20
 20 cm, 8"



FAURE

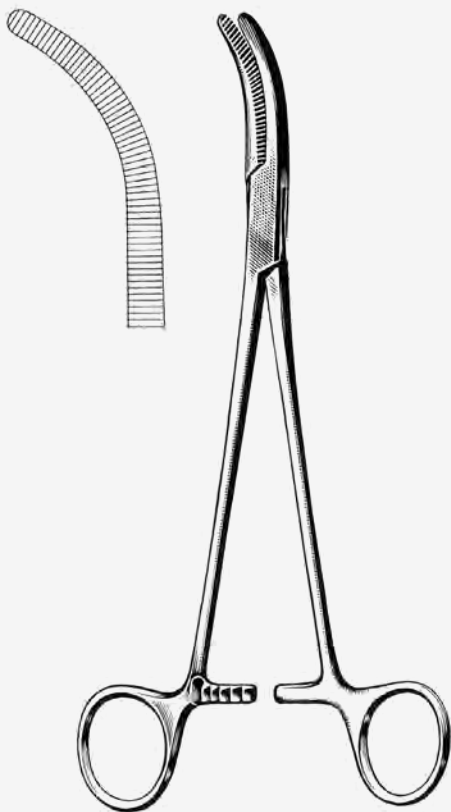

WERTHEIM
07-4613.25
 25 cm, 10"



HEANEY
07-6321.20
 20 cm, 8"



HEANEY
07-6323.20
 20 cm, 8"

07

Schlauchklemmen
Tubing Clamps
Pincas serre-tubes
Pinzas-clamps para tubos



MOD. BERLIN

07-9906.14

14,5 cm, 5 1/2"

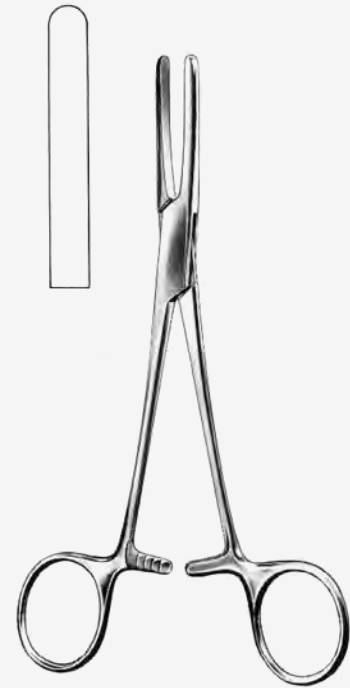

PRESBYTERIAN-HOSPITAL

07-9912.16

16 cm, 6 1/4"



07-9900.15

15 cm, 5 3/4"



07-9900.18

18 cm, 7"



07-9900.20

20 cm, 8"

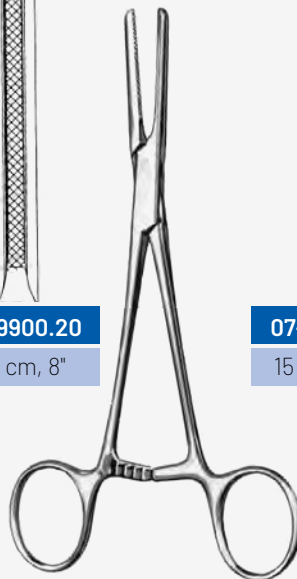

07-9902.15

15 cm, 5 3/4"



07-9902.18

18 cm, 7"



07-9902.20

20 cm, 8"



Chapter 08

Table of Contents

Tuchklemmen, Korn- und Tupferzangen / **p. 154 - 156**

Towel Clamps, Swab and Cotton Forceps / **p. 154 - 156**

Pinces serre-tubes, pincers à champs, pincers à pansements et à polypes / **p. 154 - 156**

Pinzas para tubos, pinzas de campo, pinzas para pólipos y esponjas / **p. 154 - 156**





08

Tuchklemmen
Towel clamps
Pincés à champs
Pinzas de campo



SCHAEDEL

08-9021.09

9 cm, 3 1/2"



JONES

08-9013.09

9 cm, 3 1/2"



JONES-CLIP

08-9015.09

9 cm, 3 1/2"



BACKHAUS

08-9065.09

9 cm, 3 1/2"

08-9065.11

11 cm, 4 1/2"

08-9065.13

13 cm, 5"

08-9065.15

15 cm, 5 3/4"



BACKHAUS-CLIP

08-9067.11

11 cm, 4 1/2"



ROEDER

08-9069.13

13 cm, 5"



LORNA

08-9111.11

11 cm, 4 1/2"

08-9111.13

13 cm, 5"



BALL AND SOCKET

08-9121.13

13 cm, 5"



BERNHARD

08-9101.16

16,5 cm, 6 1/2"



MOYNIHAN

08-9103.19

19 cm, 7 1/2"



DOYEN

08-9043.18

18 cm, 7"



LANE

08-9050.20

20 cm, 8"

08

Tupferzangen
Dressing Forceps
 Pincas à pansement
 Pinzas para taponos



GROSS-MAIER

08-9380.20 20 cm, 8"

08-9380.25 25 cm, 10"



GROSS-MAIER

08-9381.20 20 cm, 8"

08-9381.25 25 cm, 10"



ULRICH

08-9510.22 22 cm, 8 1/2"

08-9510.25 25 cm, 10"



ULRICH

08-9511.22 22 cm, 8 1/2"

08-9511.25 25 cm, 10"

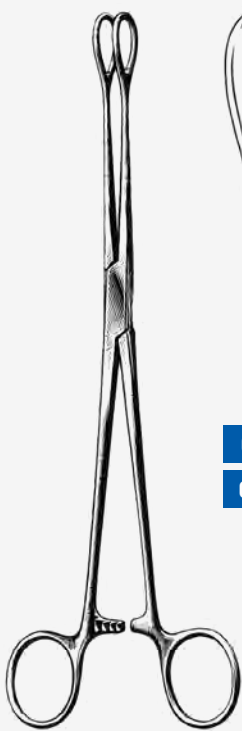

08-9520.18	18 cm, 7"	08-9521.18
08-9520.25	25 cm, 10"	08-9521.25

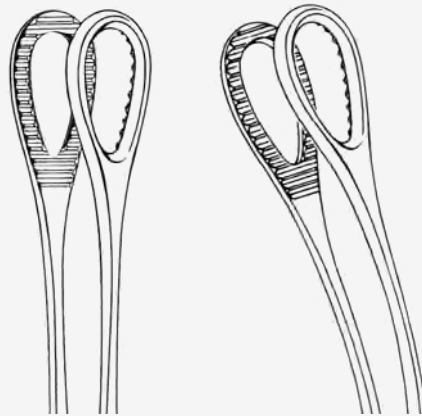
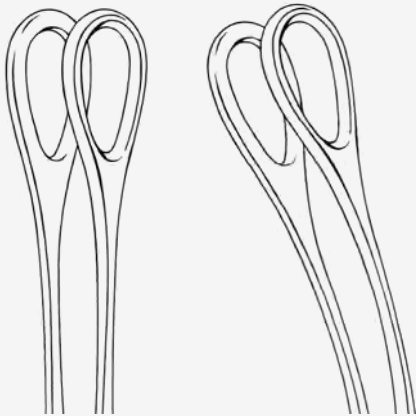

08-9522.18	18 cm, 7"	08-9523.18
08-9522.20	20 cm, 8"	08-9523.20
08-9522.25	25 cm, 10"	08-9523.25

FOERSTER

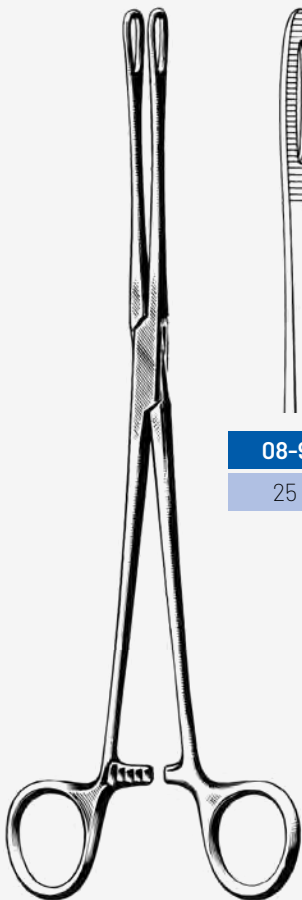

08-9544.25
25 cm, 10"

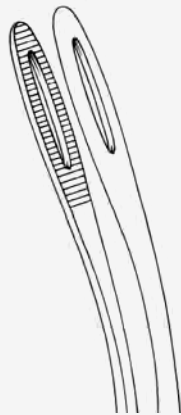

08-9545.25
25 cm, 10"

FOERSTER



RAMPLEY
08-9546.25
25 cm, 10"

08

Schwammzangen
Sponge Holding Forceps
Pinces porte-éponges
Pinzas porta-esponjas



BRYANT
08-9547.13
13 cm, 5"



LISTER
08-9306.13
13 cm, 5"

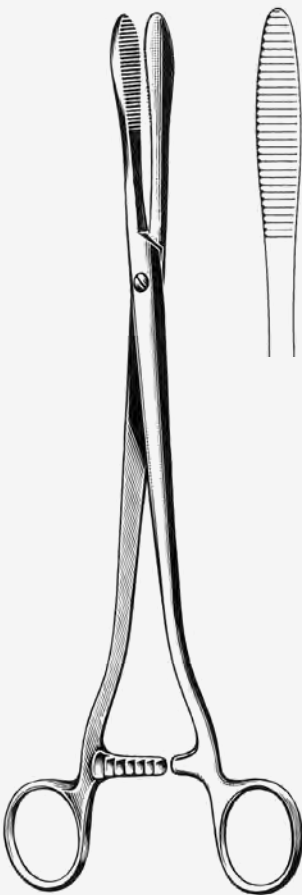

COLLIN
08-9500.25
25 cm, 10"

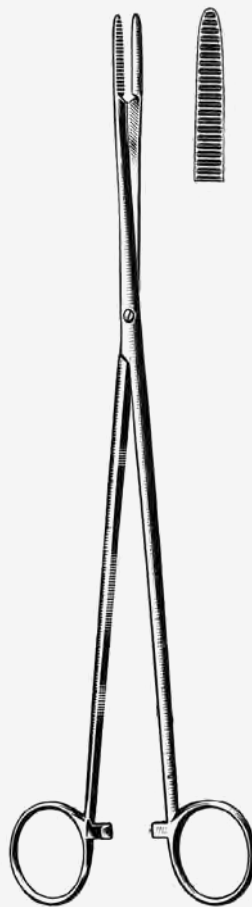

PELKMANN
08-9346.25
25 cm, 10"



CHERON
08-9503.25
25 cm, 10"

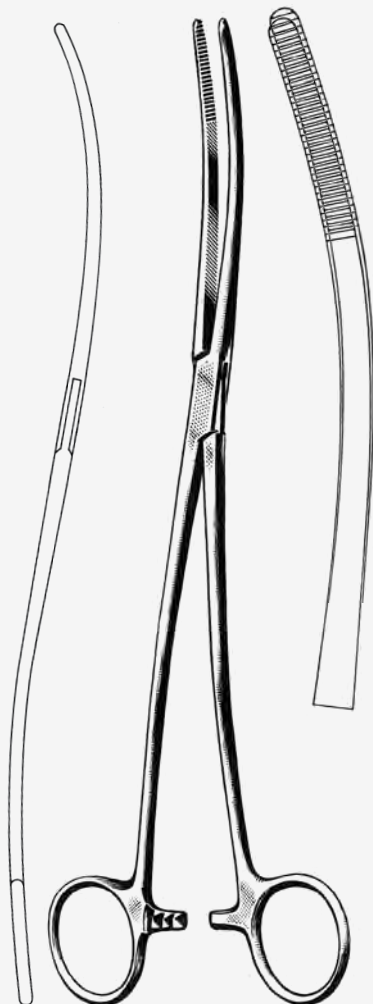

BOZEMANN

08-9570.26

26 cm, 10 1/4"

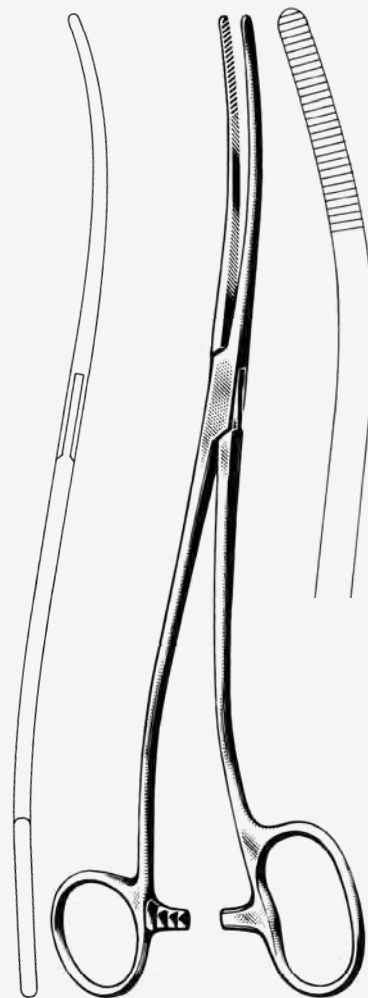

BOZEMANN-DOUGLAS

08-9579.26

26 cm, 10 1/4"

Chapter 09

Table of Contents

Wundhaken, Wundsperrer / **p. 120 - 154**

Wound Retractors / **p. 120 - 154**

Ecarteurs / **p. 120 - 154**

Separadores / **p. 120 - 154**





09

Wundhaken
Retractors
Ecarteurs
Separadores



Satz/Set/
Jeu/Juego

FARABEUF

09-2543.00



Satz/Set/
Jeu/Juego

FARABEUF

09-2545.00

Satz/Set/
Jeu/Juego



Satz/Set/
Jeu/Juego

PARKER

09-2563.00

PARKER

09-2568.00



Satz/Set/
Jeu/Juego

MATHIEU

09-2589.00

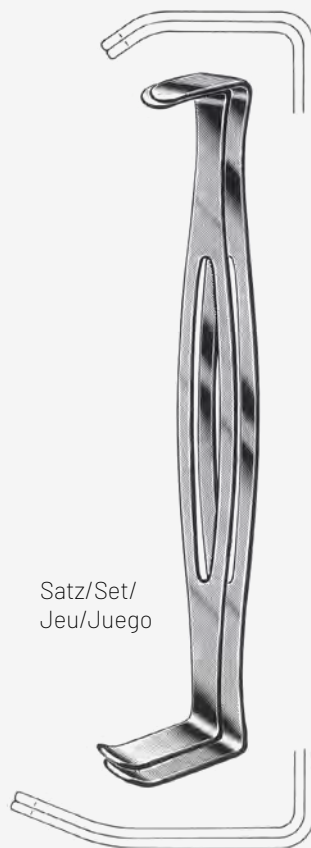

Satz/Set/
Jeu/Juego

PARKER-LANGENBECK

(US-ARMY)

09-2591.00



Satz/Set/
Jeu/Juego

ROUX

09-2516.00

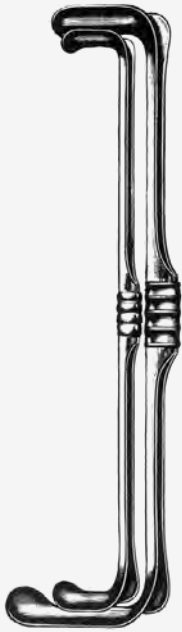

RICHARDSON-EASTMAN

09-2075.00



RICHARDSON



09-2074.28

28 x 20 mm



09-2074.36

36 x 28 mm



09-2074.44

44 x 38 mm



52 x 22 mm

RICHARDSON

09-2074.52



65 x 50 mm

KELLY

09-2076.65

26 cm, 10 1/4"

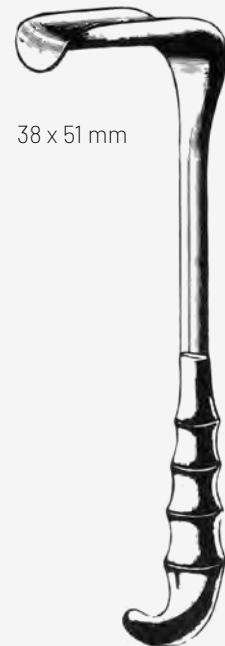

38 x 51 mm

KELLY

09-2078.38

26 cm, 10 1/4"



BABY-ROUX
09-2516.13
 13 cm, 5"



ROUX-MINI
09-2516.25
 15 cm, 5 3/4"



CRILE
09-2517.11
 11,5 cm, 4 1/2"



COLLIN-HARTMANN
09-2395.16
 16 cm, 6 1/4"



GOELET
09-2500.19
 19 cm, 7 1/2"



SENN
09-0610.16
 16 cm, 6 1/4"

spitz/sharp/
 pointu/agudo

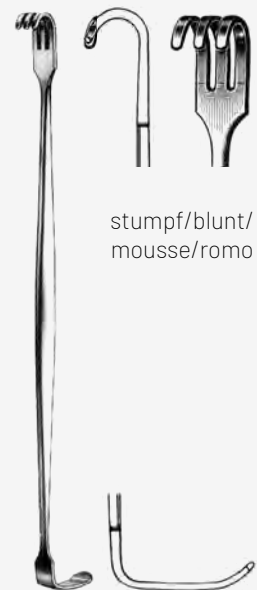

SENN
09-0611.16
 16 cm, 6 1/4"

stumpf/blunt/
 mousse/romo



09-2780.12	12 x 200 mm
09-2780.17	17 x 200 mm
09-2780.25	25 x 250 mm



09-2763.25	25 x 330 mm
09-2763.32	32 x 330 mm
09-2763.40	40 x 330 mm
09-2763.50	50 x 330 mm



HABERER	
09-2766.18	17/25 x 200 mm
09-2766.30	25/30 x 250 mm
09-2766.37	37/45 x 300 mm



REVERDIN	
09-2751.28	28 cm, 11"



HARRINGTON	
09-2232.25	25 x 320 mm
09-2232.40	40 x 320 mm
09-2232.62	62 x 320 mm



DEAVER	
09-2241.25	25 x 310 mm
09-2241.38	38 x 310 mm
09-2241.50	50 x 310 mm



DEAVER
09-2240.01
18 cm, 7"

DEAVER
09-2240.02
21,5 cm, 8 1/4"

DEAVER
09-2240.03
23 cm, 9"

DEAVER
09-2240.04
30 cm, 12"

DEAVER
09-2240.05
33 cm, 13"



DEAVER
09-2240.06
36 cm, 14"

DEAVER
09-2240.07
30 cm, 12"

DEAVER
09-2240.08
30 cm, 12"

DEAVER
09-2240.09
30 cm, 12"



09-0350.12

12 cm, 4 3/4"

spitz
sharp
pointu
agudo

Irishäkchen
Iris Hooks
Crochets à iris
Ganchos para iris

GRAEFE



09-0351.12

12 cm, 4 3/4"

stumpf
blunt
mousse
romo



09-0362.01

12 cm, 4 3/4"

Fig. 1

Irishäkchen
Iris Hooks
Crochets à iris
Ganchos para iris

GUTHRIE



09-0362.02

12 cm, 4 3/4"

Fig. 2



FRAZIER

09-0136.13

13 cm, 5"

09-0136.18

18 cm, 7"



JOSEPH

1 mm

09-0516.01

16 cm, 6 1/4"

2 mm

09-0516.02

16 cm, 6 1/4"

5 mm

09-0516.05

16 cm, 6 1/4"

7 mm

09-0516.07

16 cm, 6 1/4"

10 mm

09-0516.10

16 cm, 6 1/4"

09

Wundhaken
Retractors
 Ecarteurs
 Separadores

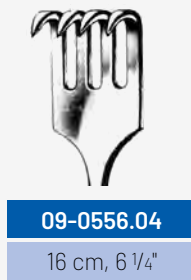
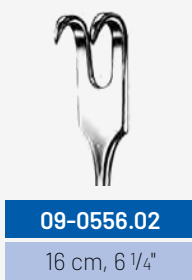
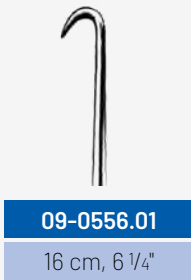

spitz
sharp
pointu
agudo

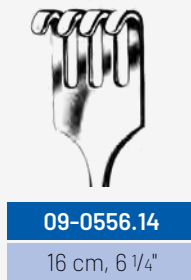
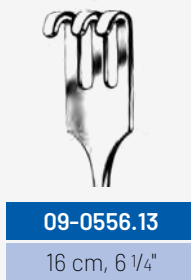
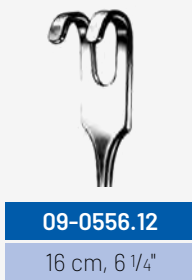

stumpf
blunt
mousse
romo



spitz
sharp
pointu
agudo



stumpf
blunt
mousse
romo

8 mm



09-0940.08

20 cm, 8"

10 mm



09-0940.10

20 cm, 8"

12 mm



09-0940.12

20 cm, 8"

14 mm



09-0940.14

20 cm, 8"

16 mm



09-0940.16

20 cm, 8"

18 mm



09-0940.18

20 cm, 8"



CUSHING

09-0850.20

20 cm, 8"

12 mm



09-0856.12

16 cm, 6 1/4"

14 mm



09-0856.14

16 cm, 6 1/4"

16 mm



09-0856.16

16 cm, 6 1/4"

18 mm



09-0856.18

16 cm, 6 1/4"



DESMARRES



CUSHING



CUSHING

09-0850.21

21,5 cm, 8 1/4"

09

Wundhaken
Retractors
 Ecarteurs
 Separadores



10 x 6 mm



09-0836.16

16 cm, 6 1/4"

20 x 6 mm



09-0836.26

16 cm, 6 1/4"

SENN-GREEN



18 x 7 mm



09-1071.01

18 cm, 7"

16 x 5 mm



09-1071.02

18 cm, 7"

7 x 4 mm



09-1071.03

18 cm, 7"

7 x 4 mm



09-1071.04

18 cm, 7"

10 x 3 mm



09-1071.05

18 cm, 7"

7 x 9 mm



09-1071.06

18 cm, 7"

MEYERDING

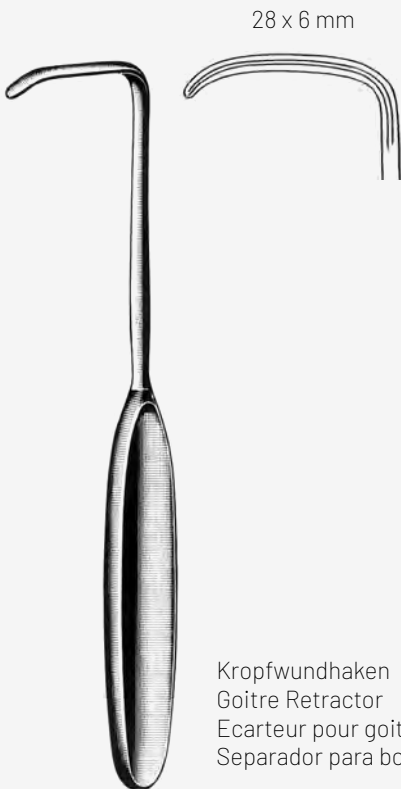

28 x 6 mm



Kropfwundhaken
 Goitre Retractor
 Ecarteur pour goitre
 Separador para bocio

LAHEY

09-1239.28

19 cm, 7 1/2"



12 x 14 mm



LITTLE

09-1242.12

20 cm, 8"



09-0591.02

11,5 cm, 4 1/2"



09-0591.12

11,5 cm, 4 1/2"



09-0591.02

11,5 cm, 4 1/2"



09-0591.12

11,5 cm, 4 1/2"



09-0591.03

11,5 cm, 4 1/2"



09-0591.13

11,5 cm, 4 1/2"



09-0591.04

11,5 cm, 4 1/2"



09-0591.14

11,5 cm, 4 1/2"



09-0591.06

11,5 cm, 4 1/2"



09-0591.16

11,5 cm, 4 1/2"



VOLKMANN



09-1061.01

21,5 cm, 8 1/4"



09-1061.11

21,5 cm, 8 1/4"



09-1061.01

21,5 cm, 8 1/4"



09-1061.11

21,5 cm, 8 1/4"



09-1061.02

21,5 cm, 8 1/4"



09-1061.12

21,5 cm, 8 1/4"



09-1061.03

21,5 cm, 8 1/4"



09-1061.13

21,5 cm, 8 1/4"



09-1061.04

21,5 cm, 8 1/4"



09-1061.14

21,5 cm, 8 1/4"



09-1061.06

21,5 cm, 8 1/4"



09-1061.16

21,5 cm, 8 1/4"



VOLKMANN

09

Wundhaken
Retractors
Ecarteurs
Separadores

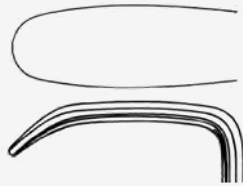

09-1172.01

30 x 11 mm

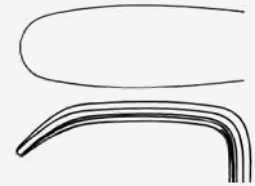

09-1181.01

30 x 11 mm

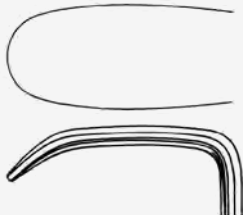

09-1172.02

30 x 14 mm

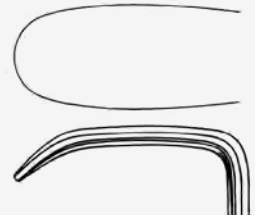

09-1181.02

30 x 14 mm

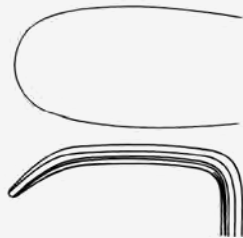

09-1172.03

30 x 16 mm

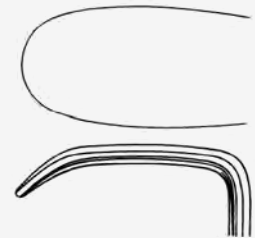

09-1181.03

30 x 16 mm

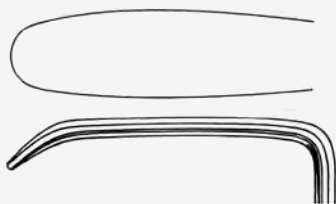

09-1172.04

40 x 11 mm

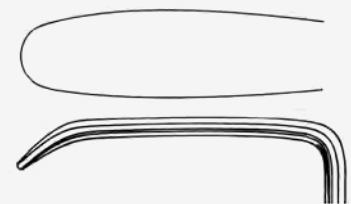

09-1181.04

40 x 11 mm

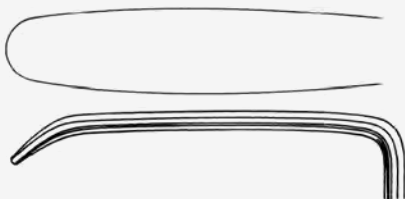

09-1172.05

50 x 11 mm

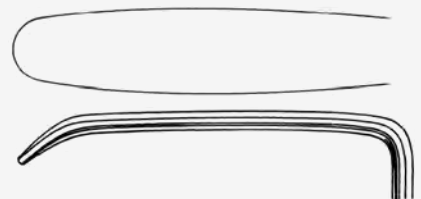

09-1181.05

50 x 11 mm



LANGENBECK

22 cm, 8 1/2"



LANGENBECK

21 cm, 8 1/4"



60 x 20 mm

LANGENBECK

09-1191.60

21 cm, 8 1/4"

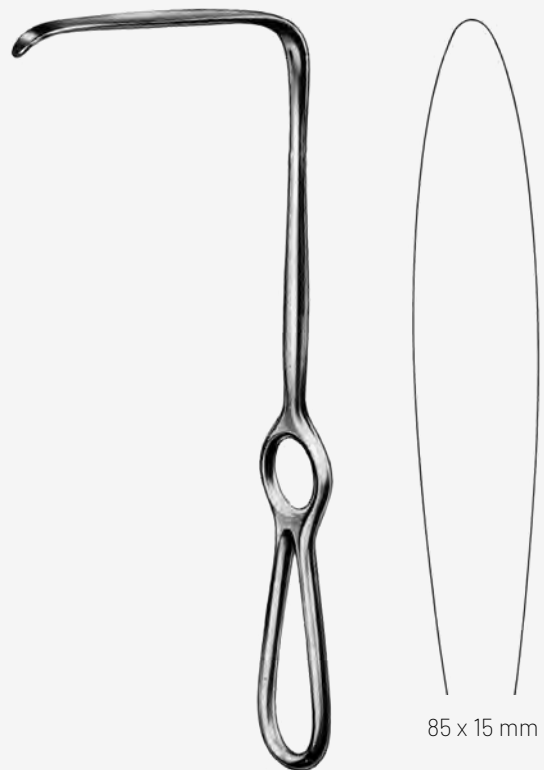

85 x 15 mm

LANGENBECK

09-1221.85

21 cm, 8 1/4"



KOCHER-LANGENBECK

21 cm, 8 1/4"

09-1233.00	23 x 8 mm
09-1233.01	25 x 6 mm
09-1233.02	35 x 8 mm
09-1233.03	35 x 11 mm
09-1233.04	35 x 15 mm
09-1233.05	40 x 11 mm
09-1233.06	55 x 11 mm
09-1233.07	70 x 14 mm
09-1233.08	80 x 12 mm
09-1233.09	80 x 16 mm



09-1254.18	40 x 18 mm
09-1254.20	60 x 20 mm
09-1254.25	60 x 25 mm
09-1254.30	75 x 30 mm
09-1254.40	75 x 40 mm

KOCHER
 23 cm, 9"



KOCHER
 19 cm, 7 1/2"



09-1273.19
 19 x 12 mm



09-1273.21
 21 x 14 mm

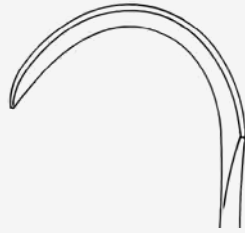

09-1275.10	40 x 10 mm
09-1275.15	40 x 15 mm
09-1275.20	40 x 20 mm

KOCHER
 22 cm, 8 1/2"



Schilddrüsenhaken
 Thyroid Gland Retractor
 Ecarteur pour la thyroïde
 Separador para glándula tiroidea

GREEN
 09-2050.22
 22 cm, 8 1/2"



14 x 17 mm



09-2010.14
 21,5 cm, 8 1/4"

20 x 22 mm



09-2010.20
 22 cm, 8 1/2"

26 x 30 mm



09-2010.26
 23,5 cm, 9 1/4"

MIDDELDORPF

09

Wundhaken
Retractors
Ecarteurs
Separadores



09-1155.40

40 x 40 mm



09-1155.50

45 x 50 mm



OLLIER

09-1145.08

22,5 cm, 8 3/4"



ISRAEL

25 cm, 10"



09-1155.60

50 x 60 mm

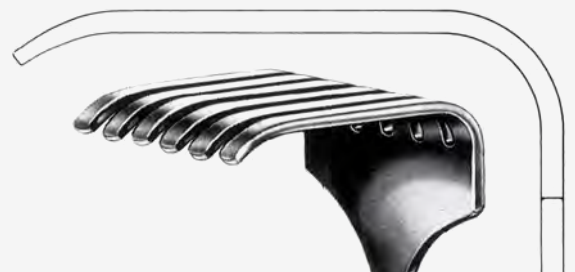

09-1155.70

70 x 70 mm



09-1124.08
 40 x 30 mm

09-1124.18
 40 x 30 mm

KOERTE
 23,5 cm, 9 1/4"

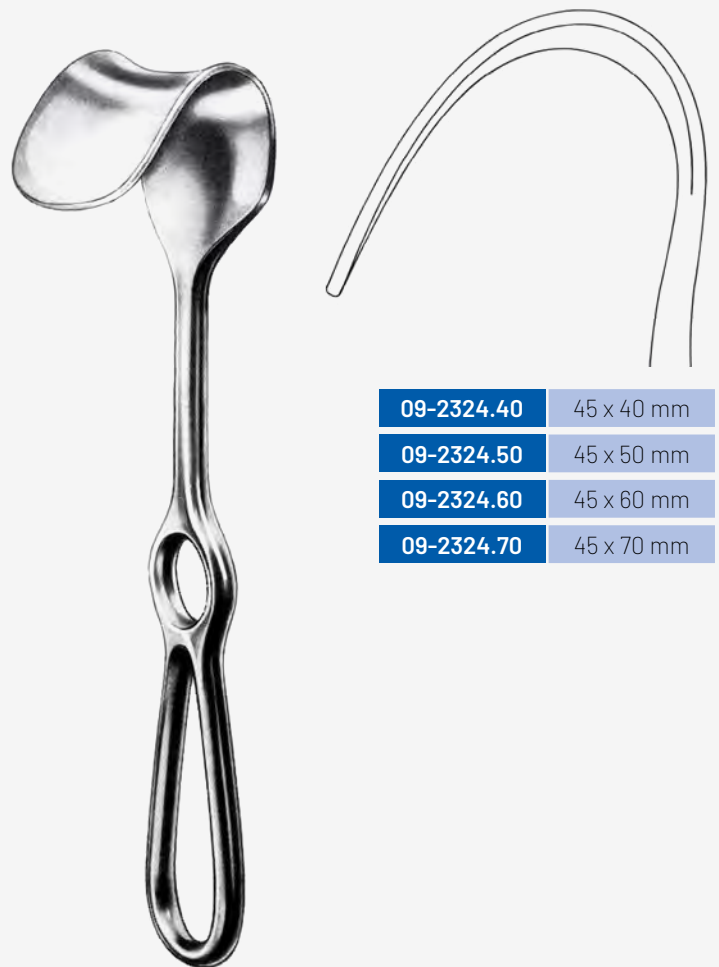

09-2324.40	45 x 40 mm
09-2324.50	45 x 50 mm
09-2324.60	45 x 60 mm
09-2324.70	45 x 70 mm

FRITSCH
 24 cm, 9 1/2"

**KOCHER**

09-2345.45 80 x 45 mm

09-2345.55 80 x 55 mm

09-2345.65 80 x 65 mm

25 cm, 10"

70 x 25 mm

**KOCHER**

09-2342.25

22,5 cm, 8 3/4"

50 x 85 mm

**DOYEN**

09-2335.85

25 cm, 10"

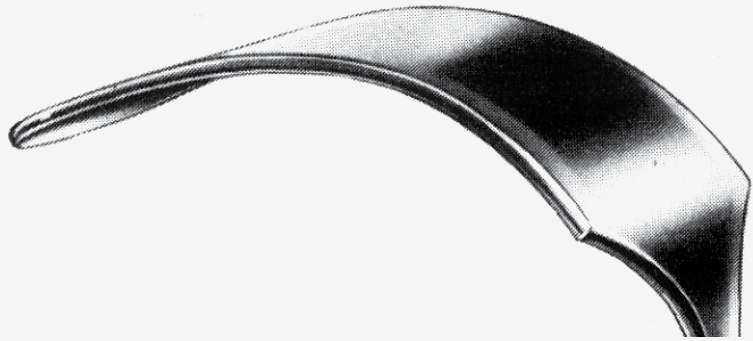

09-2361.35

95 x 35 mm

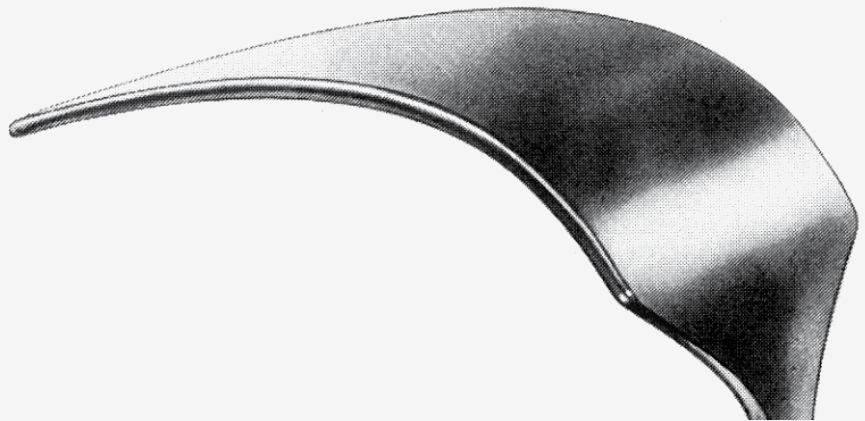

09-2361.50 120 x 50 mm

09-2361.55 150 x 50 mm

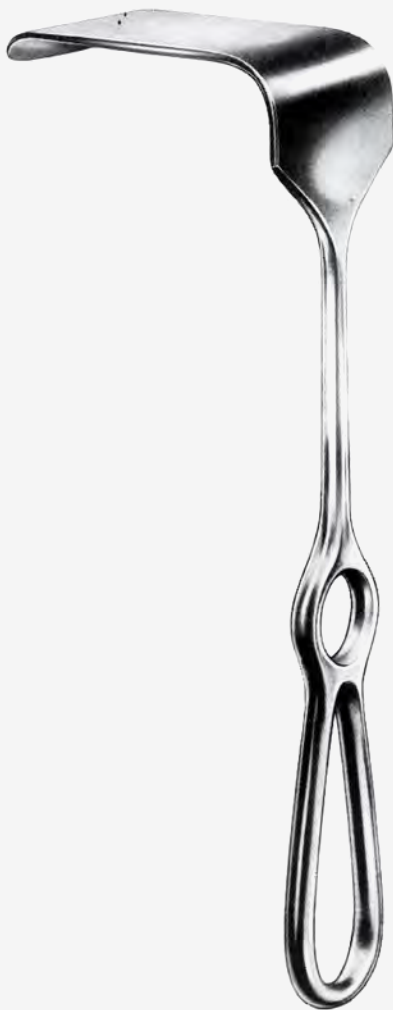

MIKULICZ

26 cm, 10 1/4"

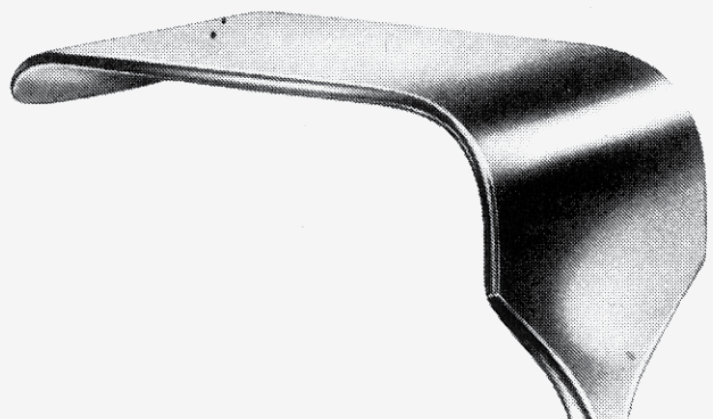

09-2361.60

90 x 50 mm

09

Wundhaken
Retractors
Ecarteurs
Separadores

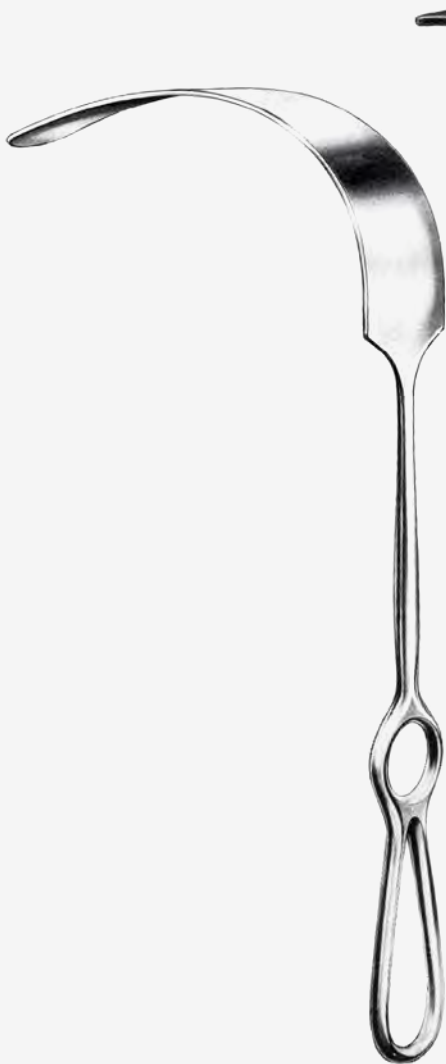

KELLY

09-2371.38 160 x 38 mm

09-2371.57 160 x 57 mm

27 cm, 10 1/2"

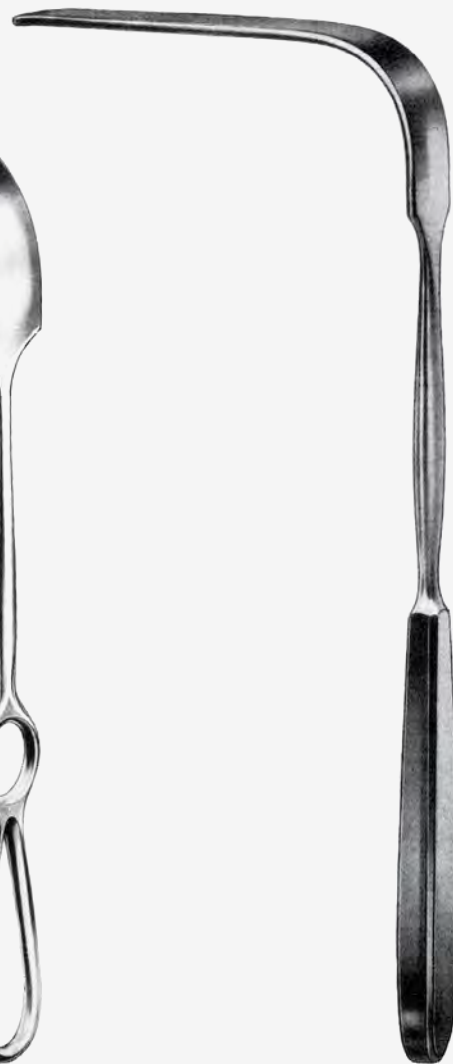

SIMON

09-2268.22 115 x 22 mm

09-2268.27 117 x 27 mm

28 cm, 11"

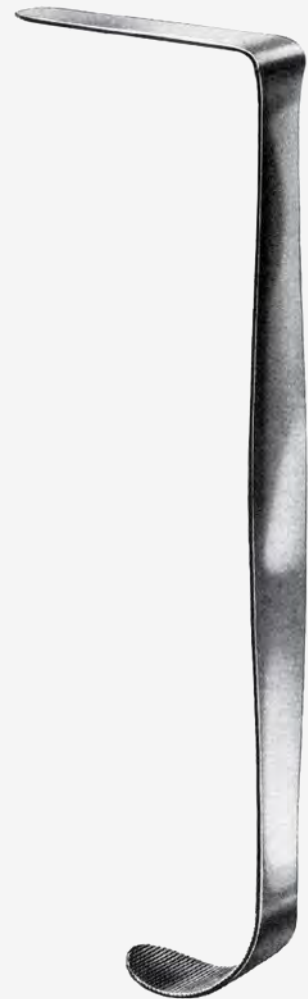

HEANEY

09-2269.45 45 x 25 mm

09-2269.73 73 x 28 mm

09-2269.82 82 x 28 mm

27 cm, 10 1/2"



CORYLLOS

09-2252.22 82 x 22 mm

09-2252.38 115 x 38 mm

09-2252.45 108 x 45 mm

09-2252.65 115 x 65 mm

22,5 cm, 8 3/4"



SAUERBRUCH

09-2255.45 45 x 15 mm

09-2255.60 60 x 23 mm

09-2255.75 75 x 20 mm

25 cm, 10"



125 x 37 mm

SAUERBRUCH

09-2255.25

25 cm, 10"



Scapula-Haken
Scapula Retractor
Ecarteur à omoplate
Separador para escápula

DAVIDSON

09-2061.50

75 x 50 mm



Scapula-Haken
Scapula Retractor
Ecarteur à omoplate
Separador para escápula

DAVIDSON

09-2061.90

75 x 90 mm

stumpf
blunt
mousse
romo

scharf
sharp
pointu
agudo

Wundspreizer, selbsthaltend
Self-retaining Retractors
Ecarteurs autostatiques
Separadores autostáticos

09



FINSEN

09-5134.34

09-5134.44

7 cm, 2 3/4"



ALM

09-5107.04

09-5107.14

7 cm, 2 3/4"



ALM

09-5110.04

09-5110.14

10 cm, 3 3/4"



JANSEN

09-5312.03

09-5312.13

10 cm, 3 3/4"



KAUPP

09-5130.04

09-5130.14

10 cm, 3 3/4"



WEITLANER

09-5211.23

09-5211.43

11,5 cm, 4 1/2"

09

Wundspreizer, selbsthaltend
Self-retaining Retractors
 Ecarteurs autostatiques
 Separadores autostáticos

 stumpf
 blunt
 mousse
 romo

 scharf
 sharp
 pointu
 agudo



WEITLANER-WULLSTEIN

09-5213.34

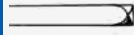

09-5213.44

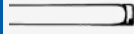

13 cm, 5"



PLESTER

09-5363.11

11 cm, 4 1/4"



PLESTER

09-5364.11

11 cm, 4 1/4"



WEITLANER

09-5214.34



09-5214.44

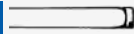

14 cm, 5 1/2"



WEITLANER

09-5216.34



09-5216.44

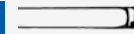

16 cm, 6 1/4"



WEITLANER

09-5220.34



09-5220.44

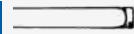

20 cm, 8"

stumpf
blunt
mousse
romo

scharf
sharp
pointu
agudo

Wundspreizer, selbsthaltend
Self-retaining Retractors
Ecarteurs autostatiques
Separadores autostáticos

09

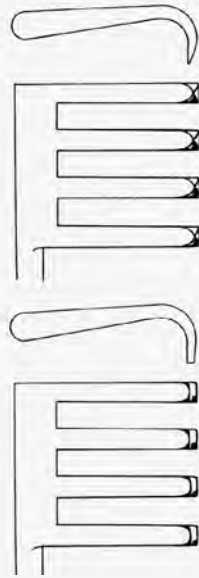

3 x 4

5 x 4

4 x 4



ADSON

09-5620.44

09-5620.84

19 cm, 7 1/2"



ADSON

09-5626.44

09-5626.84

26,5 cm, 10 1/2"



ADSON

09-5693.45

32 cm, 12 3/4"

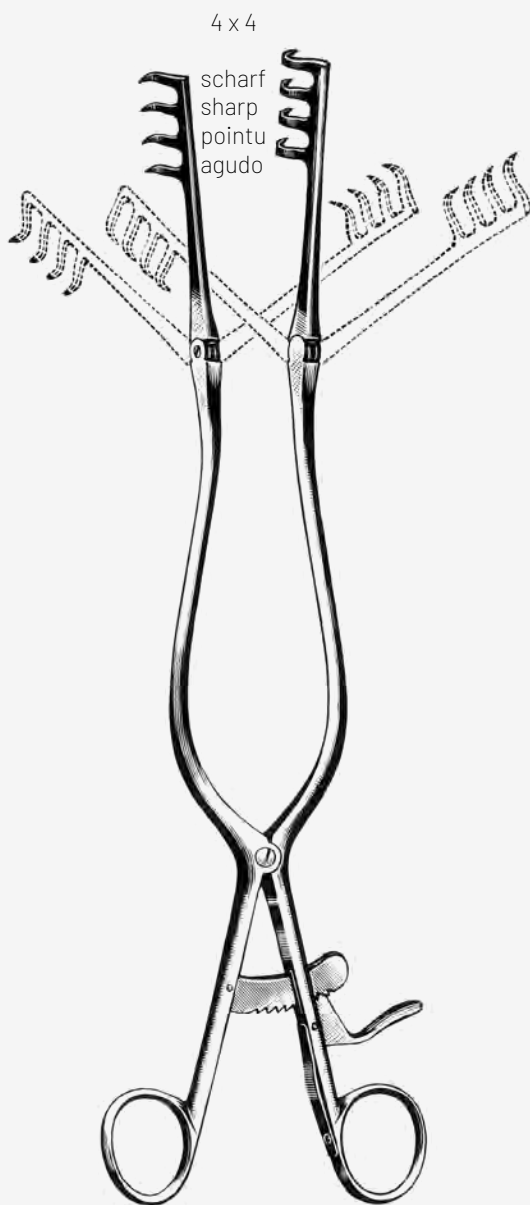

BECKMANN
09-5681.44
 31 cm, 12 1/2"



BECKMANN-EATON
09-5702.77
 32 cm, 12 3/4"

 stumpf
 blunt
 mousse
 romo

 scharf
 sharp
 pointu
 agudo

Wundspreizer, selbsthaltend
Self-retaining Retractors
 Ecarteurs autostatiques
 Separadores autostáticos

09



MOLLISON

09-5445.44

15 cm, 5 3/4"



DARLING

09-5854.18

18 cm, 7"



DARLING

09-5855.18

18 cm, 7"

09

Wundspreizer, selbsthaltend
Self-retaining Retractors
 Ecarteurs autostatiques
 Separadores autostáticos

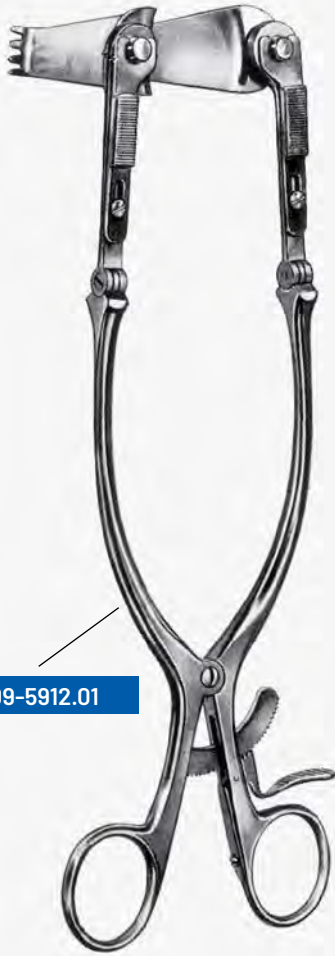

09-5912.01

CLOWARD

25 cm, 10"



09-5912.40

40 mm



09-5912.45

45 mm



09-5912.50

50 mm



09-5912.55

55 mm



09-5912.60

60 mm

09-5912.00

Satz / Set / Jeu / Juego

09-5912.01 - 09-5912.60

09-5912.95

Satz / Set / Jeu / Juego

09-5912.40 - 09-5912.60



09-5910.01

CLOWARD

17 cm, 6 3/4"



09-5910.40

40 mm



09-5910.45

45 mm



09-5910.50

50 mm



09-5910.55

55 mm



09-5910.60

60 mm

09-5910.00

Satz / Set / Jeu / Juego

09-5910.01 - 09-5910.60

09-5910.95

Satz / Set / Jeu / Juego

09-5910.40 - 09-5910.60



GELPI

09-6830.09	9 cm, 3 1/2"
09-6830.14	14 cm, 5 1/2"
09-6830.16	16 cm, 6 1/4"
09-6830.18	18 cm, 7"



GELPI

09-6832.18	18 cm, 7"
-------------------	-----------



RIGBY

09-6831.18	18 cm, 7"
-------------------	-----------

09

Bauchdeckenhalter
Abdominal Retractors
Ecarteurs abdominaux
Separadores abdominales

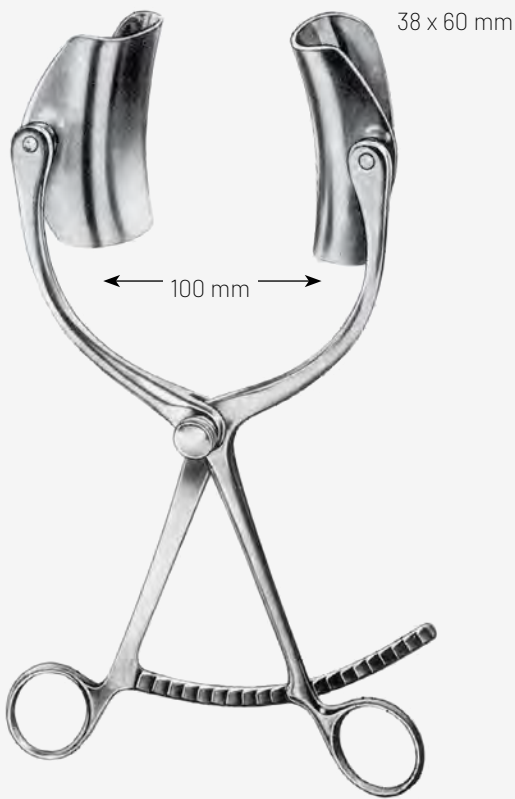

COLLIN

09-6040.10



COLLIN

09-6041.60



COLLIN

09-6041.80

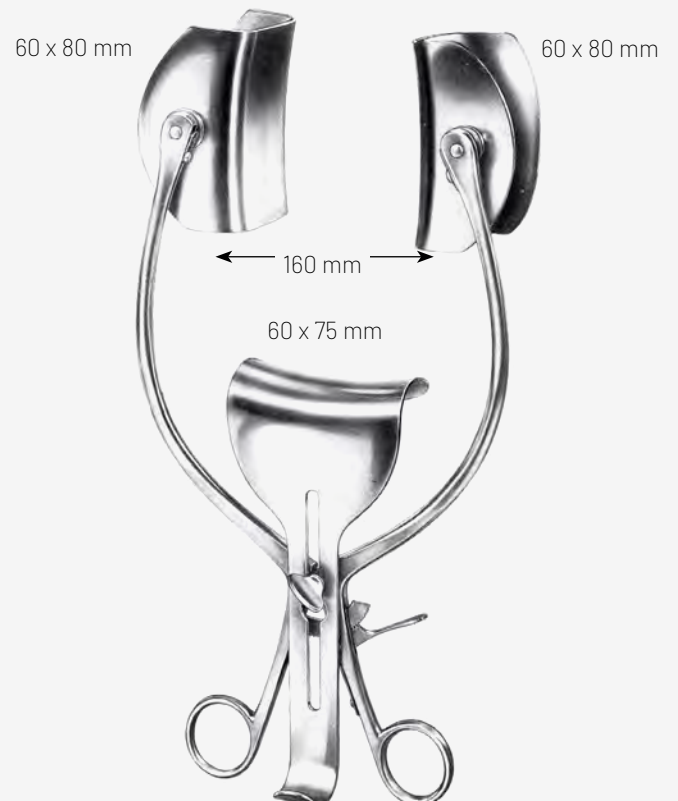

COLLIN-LOKTITE

09-6050.10

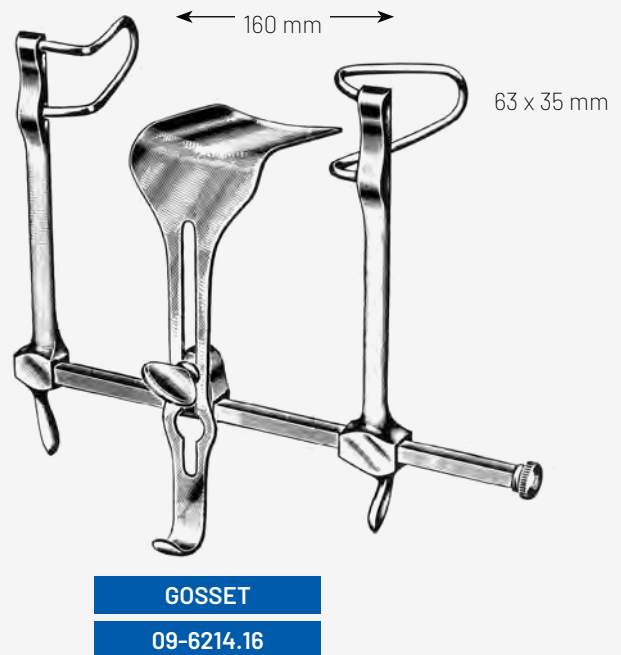
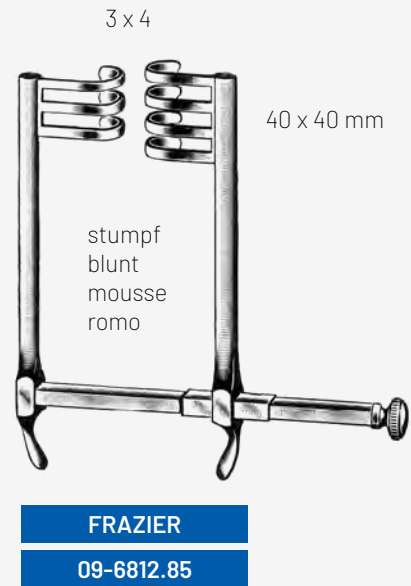

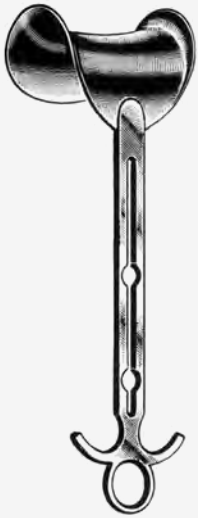

BALFOUR

09-6230.45 45 x 80 mm

09-6230.70 70 x 85 mm

09-6230.80 80 x 90 mm

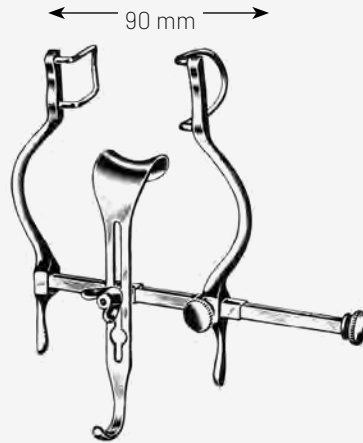

BALFOUR-BABY

09-6232.09

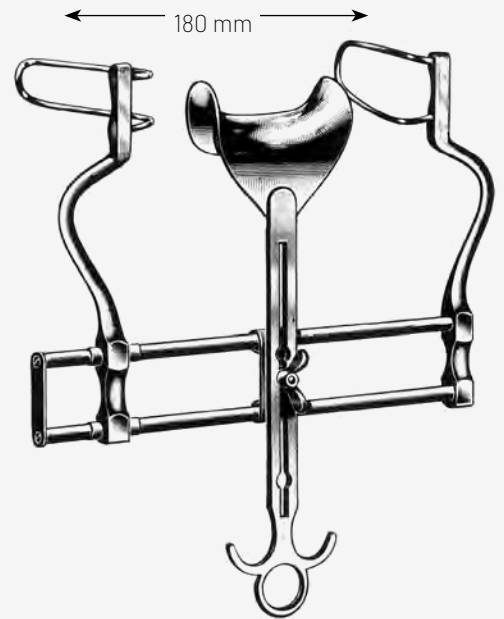

BALFOUR

09-6240.18



BALFOUR

09-6244.20

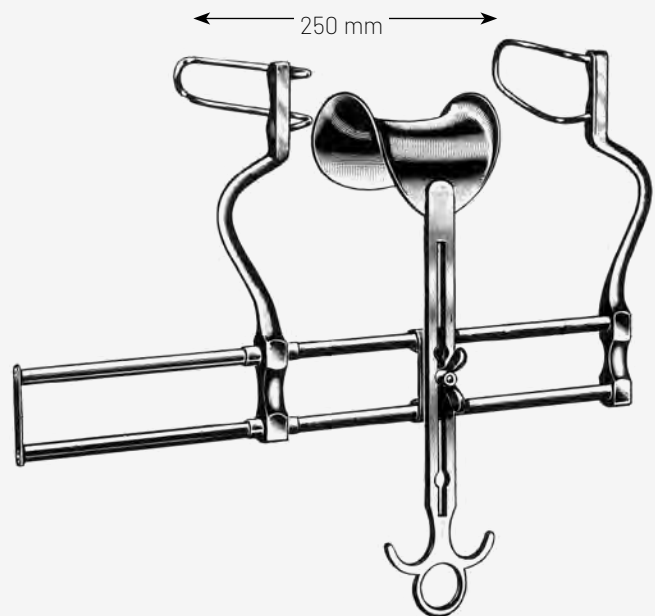

BALFOUR

09-6244.25



KIRSCHNER

09-6330.10



KIRSCHNER

09-6320.10

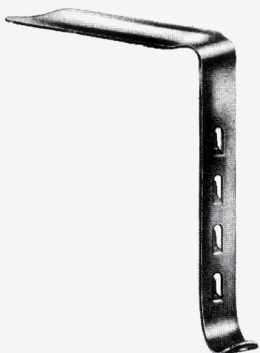

KIRSCHNER

09-6324.10

105 x 35 mm

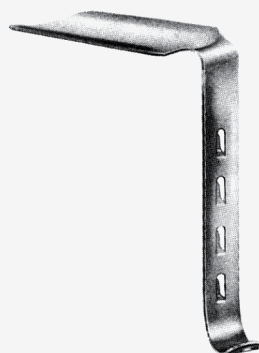

KIRSCHNER

09-6324.98

98 x 50 mm



KIRSCHNER

09-6320.55

40 x 55 mm



KIRSCHNER

09-6320.65

50 x 65 mm



Muskelhaken
Muscle Hooks
Ecarteurs musculaires
Ganchos musculares

09-7924.10

10,5 cm, 4 1/4"



Muskelhaken
Muscle Hooks
Ecarteurs musculaires
Ganchos musculares

09-7915.03

Chapter 10

Table of Contents

Sonden, Spatel, Watteträger / **p. 120 - 154**

Sounds, Spatula, Cotton Applicators / **p. 120 - 154**

Porte-coton, sondes, stylets / **p. 120 - 154**

Sondas, espátulas, porta-algodón / **p. 120 - 154**

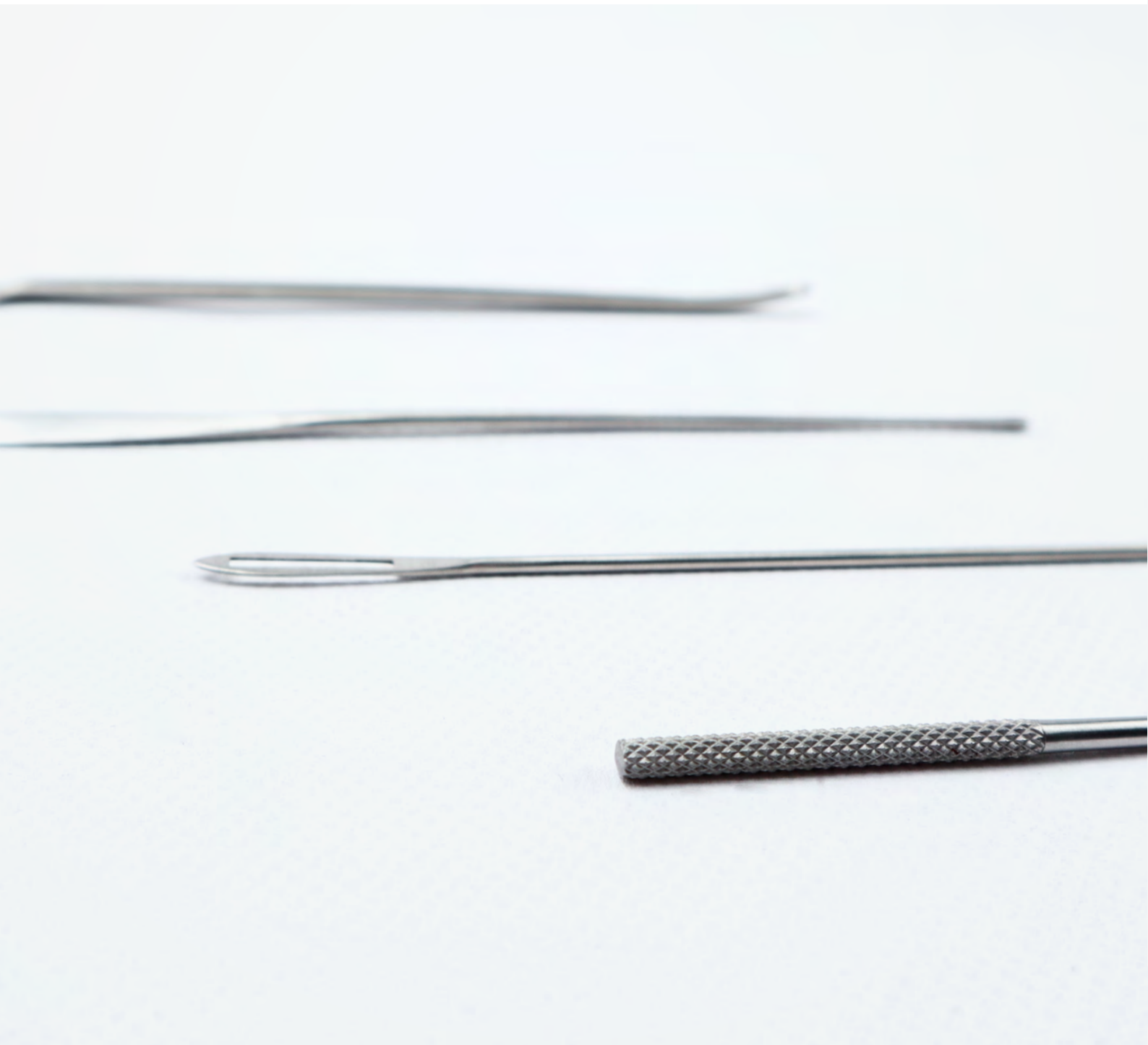



10

Sonden
Probes, Directors
 Stylets, sondes
 Estiletos, sondas

Ø 2 mm



10-0010.11	11,5 cm, 4 1/2"
10-0010.13	13 cm, 5"
10-0010.14	14,5 cm, 5 1/2"
10-0010.16	16 cm, 6 1/4"
10-0010.18	18 cm, 7"
10-0010.20	20 cm, 8"
10-0010.25	25 cm, 10"

Ø 1 mm



10-0052.11	11,5 cm, 4 1/2"
10-0052.13	13 cm, 5"
10-0052.14	14,5 cm, 5 1/2"
10-0052.16	16 cm, 6 1/4"
10-0052.18	18 cm, 7"
10-0052.20	20 cm, 8"
10-0052.25	25 cm, 10"

Ø 2 mm



10-0053.11	11,5 cm, 4 1/2"
10-0053.13	13 cm, 5"
10-0053.14	14,5 cm, 5 1/2"
10-0053.16	16 cm, 6 1/4"
10-0053.18	18 cm, 7"
10-0053.20	20 cm, 8"
10-0053.25	25 cm, 10"



10-0065.14	14,5 cm, 5 1/2"
10-0065.16	16 cm, 6 1/4"



10-0100.13	13 cm, 5"
10-0100.14	14,5 cm, 5 1/2"
10-0100.16	16 cm, 6 1/4"
10-0100.18	18 cm, 7"
10-0100.20	20 cm, 8"



10-0110.13	13 cm, 5"
10-0110.14	14,5 cm, 5 1/2"
10-0110.16	16 cm, 6 1/4"
10-0110.18	18 cm, 7"



DOYEN
10-0101.14
 14,5 cm, 5 1/2"



STACKE
10-0082.10
 10 cm, 4 1/4"

silber
 silver
 argent
 plata



10-0502.13 13 cm, 5"
10-0502.14 14 cm, 5 1/2"

Varizenbesteck
 Varicose vein probe set
 Trousse à varices
 Juego para várices

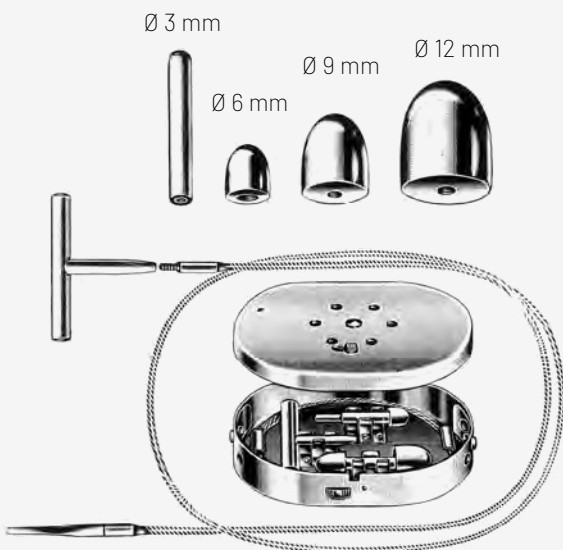

NABATOFF
10-5650.00
 Satz / Set / Jeu / Juego



10-5650.03
 Ø 3 mm



10-5650.06
 Ø 6 mm



10-5650.09
 Ø 9 mm



10-5650.12
 Ø 12 mm



10-5650.15
 Ø 15 mm



10-5650.02
 Ø 3 mm

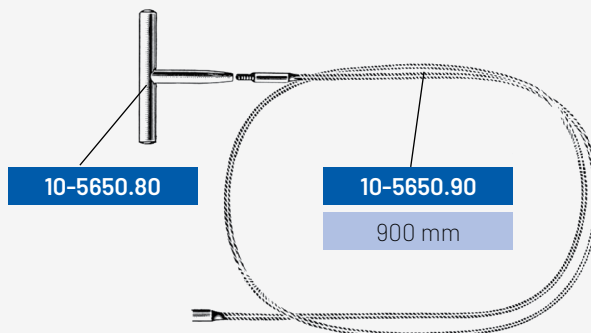

10-5650.80

10-5650.90
 900 mm

10

Wundspreizer, selbsthaltend
Self-retaining Retractors
Ecarteurs autostatiques
Separadores autostáticos



4 mm



6 mm



7 mm



8 mm



10 mm



12 mm



14 mm

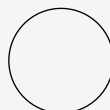

10-5681.04	4 mm
10-5681.06	6 mm
10-5681.07	7 mm
10-5681.08	8 mm
10-5681.10	10 mm
10-5681.12	12 mm
10-5681.14	14 mm

10-5682.12
für / for / pour / para
10.5681.04 - 10.5681.14

Ø 1,2 mm



FARREL

10-0712.12	12 cm, 4 3/4"
10-0712.14	14 cm, 5 1/2"
10-0712.16	16 cm, 5 1/2"
10-0712.18	18 cm, 7"
10-0712.23	23 cm, 9"

Ø 1,2 mm



FARREL

10-0732.12	12 cm, 4 3/4"
10-0732.14	14 cm, 5 1/2"
10-0732.16	16 cm, 5 1/2"
10-0732.18	18 cm, 7"
10-0732.23	23 cm, 9"

Ø 1,5 mm



10-0815.12

12 cm, 4 3/4"

10-0815.14

14 cm, 5 1/2"

10-0815.16

16 cm, 5 1/2"

10-0815.18

18 cm, 7"

Ø 1,5 mm



10-0816.12

12 cm, 4 3/4"

10-0816.14

14 cm, 5 1/2"

10-0816.16

16 cm, 5 1/2"

10-0816.18

18 cm, 7"



UCKERMANN

10-0642.15

15 cm, 5 3/4"



JOBSON-HORNE

10-0828.12

12 cm, 4 3/4"

10-0828.18

18 cm, 7"



10-1150.45

Chapter 11

Table of Contents

Trokare / **p. 162 - 167**

Trocars / **p. 162 - 167**

Trocarts / **p. 162 - 167**

Trócares / **p. 162 - 167**







Trokar mit 4 Aufsätzen
 Trocar with 4 tips
 Trocart avec 4 embouts
 Trócar con 4 puntas

UNIVERSAL
 11-3004.00



11-2131.30	3,0 mm
11-2130.40	4,0 mm
11-2130.50	5,0 mm

PIERCE
 17 cm, 6 3/4"



11-3010.30	3,0 mm
11-3010.35	3,5 mm
11-3010.40	4,0 mm
11-3010.45	4,5 mm
11-3010.50	5,0 mm
11-3010.55	5,5 mm
11-3010.60	6,0 mm

18 cm, 7"



11-3012.30	3,0 mm
11-3012.35	3,5 mm
11-3012.40	4,0 mm
11-3012.45	4,5 mm
11-3012.50	5,0 mm
11-3012.55	5,5 mm
11-3012.60	6,0 mm

18 cm, 7"



DOUGLAS

11-3115.30

Ø 1,75 mm



LICHTWITZ

11-3154.18

Ø 3 mm

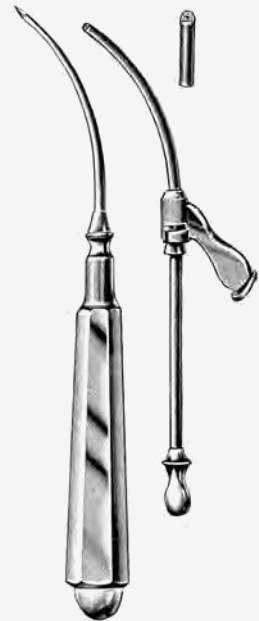

COACKLEY

11-2135.30

14 cm, 5 1/2"



Ø 5 mm

FLEURANT

11-3040.00

23 cm, 9"



NELSON

11-3020.25 Charr. 25

11-3020.30 Charr. 30

11-3020.33 Charr. 33

11-3020.35 Charr. 35



Gallenblasentrokare
 Gall Bladder Trocars
 Trocarts pour vésicule biliaire
 Trócar para vesícula biliar

11-3034.10	Charr. 10
11-3034.12	Charr. 12
11-3034.14	Charr. 14
11-3034.16	Charr. 16
11-3034.18	Charr. 18
11-3034.20	Charr. 20
11-3034.22	Charr. 22
11-3034.24	Charr. 24
11-3034.26	Charr. 26
11-3034.28	Charr. 28

OCHSNER

15 cm, 5 3/4"



VERRES

11-3851.00

2,0 x 100 mm

Kanülen für die Leberblindpunktion
 Liver Blind Puncture Needles
 Aiguilles pour la ponction avegule du foie
 Agujas para la punción ciega del higado



11-3810.35	1,0 x 35 mm
11-3810.70	1,0 x 70 mm
11-3812.70	1,2 x 70 mm
11-3812.99	1,2 x 100 mm
11-3814.70	1,4 x 70 mm
11-3814.99	1,4 x 100 mm
11-3816.70	1,6 x 70 mm
11-3818.99	1,8 x 100 mm

MENGHINI



11-3830.14 1,4 x 168 mm

11-3830.18 1,8 x 168 mm



11-3830.64 1,4 mm

11-3830.68 1,8 mm

Nadelführung
 Trumpet Needle Guide
 Aiguille trompette guide
 Aguja de guía



IOWA
 11-5220.00

Kanülen zur Lumbalpunktion
 Lumbar Puncture Needles
 Aiguilles pour ponction lombaire
 Aguja para punción lumbar



QUINKE

11-5230.12	1,2 x 76 mm
11-5232.12	1,2 x 89 mm
11-5230.10	1,0 x 76 mm
11-5232.10	1,0 x 89 mm
11-5230.07	0,7 x 76 mm
11-5232.07	0,7 x 89 mm

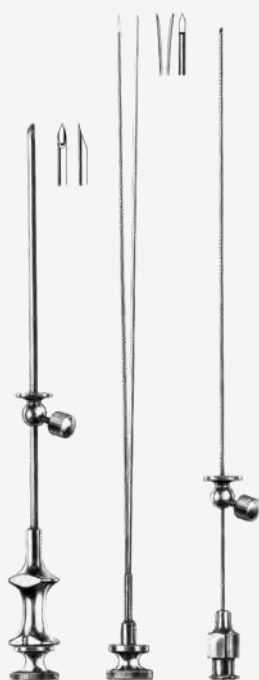

FRANKLIN-SILVERMANN
 11-5270.20
 2,0 x 105 mm



11-5270.14
 2,0 x 130 mm



11-5240.05 5 ml
11-5240.10 10 ml

Chapter 12

Table of Contents

Nadelhalter / **p. 168 - 182**

Needle Holders / **p. 168 - 182**

Porte-aiguilles / **p. 168 - 182**

Porta-agujas / **p. 168 - 182**





12

Nadelhalter
Needle Holders
Porte-aiguilles
Porta-agujas



DERF

12-5024.12

12 cm, 4 3/4"



DERF

12-5028.13

12,5 cm, 5"



COLLIER

12-5030.13

12,5 cm, 5"



HALSEY

12-5032.13

13 cm, 5"



HALSEY

12-5034.13

13 cm, 5"



NEIVERT

12-5040.13

13 cm, 5"



BAUMGARTNER

12-5042.13 12,5 cm, 5"

12-5042.14 14 cm, 5 1/2"



CRILE-WOOD

12-5302.15 15 cm, 6"

12-5302.18 18 cm, 7"

12-5302.20 20 cm, 8"



CRILE-MURRAY

12-5320.15

15 cm, 6"



MAYO-HEGAR

12-5220.14 14 cm, 5 1/2"

12-5220.16 16 cm, 6 1/4"

12-5220.18 18 cm, 7"

12-5220.20 20 cm, 8"

12-5220.24 24 cm, 9 1/2"

12-5220.26 26 cm, 10 1/4"

12-5220.30 30 cm, 12"



MAYO-HEGAR

12-5224.16 16 cm, 6 1/4"

12-5224.18 18 cm, 7"

12-5224.20 20 cm, 8"



JAMISON

12-2458.23

23,5 cm, 9 1/4"

12

Nadelhalter
Needle Holders
Porte-aiguilles
Porta-agujas



HEANEY

12-2461.21

21 cm, 8 1/2"



METZENBAUM

12-2478.18

18 cm, 7"



ADSON

12-2480.18

18 cm, 7"



MASSON

12-2466.27

27 cm, 10 3/4"



WANGENSTEEN

12-2470.27

27 cm, 10 3/4"



WANGENSTEEN

12-2474.27

27 cm, 10 3/4"



SAROT

12-2488.18 18 cm, 7"

12-2488.26 26 cm, 10 1/4"

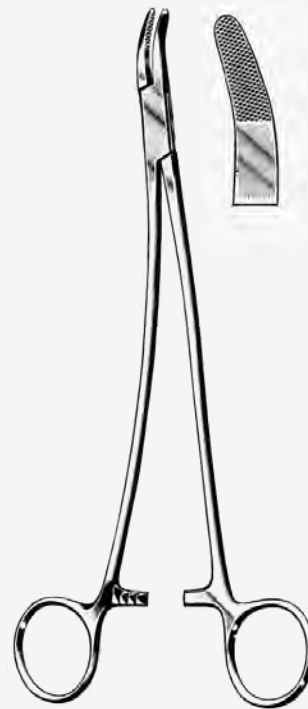

STRATTE

12-2492.23

23 cm, 9"



JOHNSON

12-2481.27

27 cm, 10 3/4"



FINOCHIETTO

12-2485.20 20 cm, 8"

12-2485.27 27 cm, 10 3/4"



HOESEL

12-2503.25

25 cm, 10"

12

Nadelhalter
Needle Holders
 Porte-aiguilles
 Porta-agujas



CRILE
 12-2496.15
 15 cm, 6"



TOENNIS
 12-2498.18
 18 cm, 7"



MATHIEU
 12-2504.14 14 cm, 5 1/2"
 12-2504.17 17 cm, 6 3/4"
 12-2504.20 20 cm, 8"
 12-2504.24 24 cm, 9 1/2"



MATHIEU
 12-2508.17 17 cm, 6 3/4"
 12-2508.20 20 cm, 8"



MATHIEU
 12-2512.14 14 cm, 5 1/2"
 12-2512.17 17 cm, 6 3/4"



OLSEN-HEGAR
 12-2516.14 14 cm, 5 1/2"
 12-2516.18 18 cm, 7"



OLSEN-HEGAR

12-2520.17

17 cm, 6 3/4"

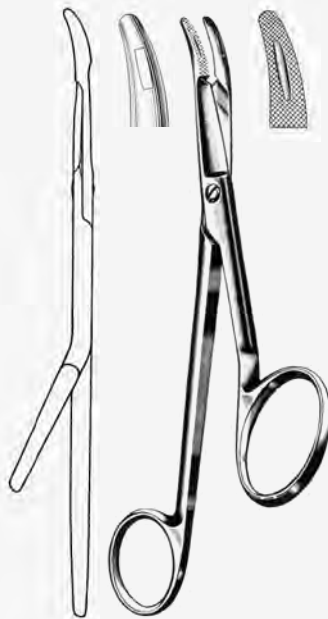

GILLIES

12-2524.16

16 cm, 6 1/4"



STEVENS

12-2532.11

11 cm, 4 1/4"



STEVENS

12-2534.13

13 cm, 5"

12-2534.15

15 cm, 6"



BOYNTON

12-2536.12

12 cm, 4 3/4"



ARRUGA

12-2538.16

16 cm, 6 1/4"

12

Nadelhalter
Needle Holders
Porte-aiguilles
Porta-agujas



KALT-ARRUGA

12-2541.14

14 cm, 5 1/2"



KALT

12-2544.14

14 cm, 5 1/2"



BARRAQUER

12-2546.10

10 cm, 4"



BARRAQUER

12-2547.10

10 cm, 4"



BARRAQUER

12-2549.13

13 cm, 5"



CASTROVIEJO

12-2552.14

14 cm, 5 1/2"



CASTROVIEJO

12-2553.14

14 cm, 5 1/2"



CASTROVIEJO

12-2556.13

13 cm, 5"

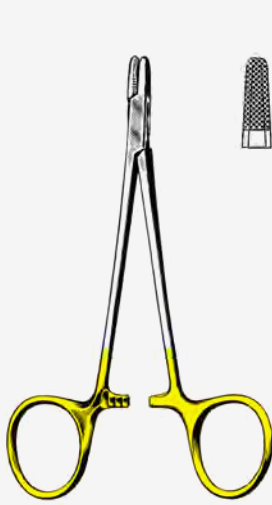

DERF
12-5026.12
 12 cm, 4 3/4"



HALSEY
12-5036.13
 13 cm, 5"



HALSEY
12-5038.13
 13 cm, 5"



BAUMGARTNER
12-5046.13 12,5 cm, 5"
12-5048.14 14 cm, 5 1/2"



CRILE-WOOD
12-5312.15 15 cm, 6"
12-5312.18 18 cm, 7"
12-5312.20 20 cm, 8"

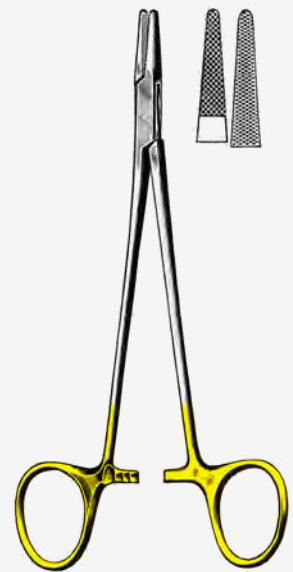

CRILE-MURRAY
12-5322.15
 15 cm, 6"

12

Nadelhalter mit Hartmetalleinlagen
Needle Holders with Tungsten Carbide Inserts
 Porte-aiguilles avec mors en tungstène
 Porta-agujas con bocas de carburo de tungsteno



MAYO-HEGAR

12-5222.14	14 cm, 5 1/2"
12-5222.16	16 cm, 6 1/4"
12-5222.18	18 cm, 7"
12-5222.20	20 cm, 8"
12-5222.24	24 cm, 9 1/2"
12-5222.26	26 cm, 10 1/4"
12-5222.30	30 cm, 12"



MAYO-HEGAR

12-5228.16	16 cm, 6 1/4"
12-5228.18	18 cm, 7"
12-5228.20	20 cm, 8"

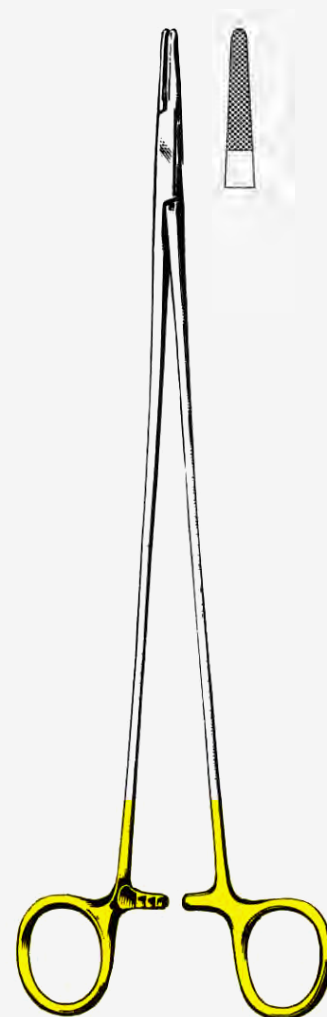

DE BAKEY

12-5450.15	15 cm, 6"
12-5450.18	18 cm, 7"
12-5450.20	20 cm, 8"
12-5450.23	23 cm, 9"
12-5450.26	26 cm, 10 1/4"
12-5450.28	28 cm, 11"
12-5450.30	30 cm, 12"



RYDER

12-5456.13	13 cm, 5"
12-5456.15	15 cm, 6"
12-5456.18	18 cm, 7"
12-5456.20	20 cm, 8"
12-5456.23	23 cm, 9"



HEANEY

12-2463.21	21 cm, 8 1/2"
------------	---------------



SAROT

12-2490.18	18 cm, 7"
12-2490.26	26 cm, 10 1/4"



JAMISON

12-2460.23	23,5 cm, 9 1/4"
------------	-----------------

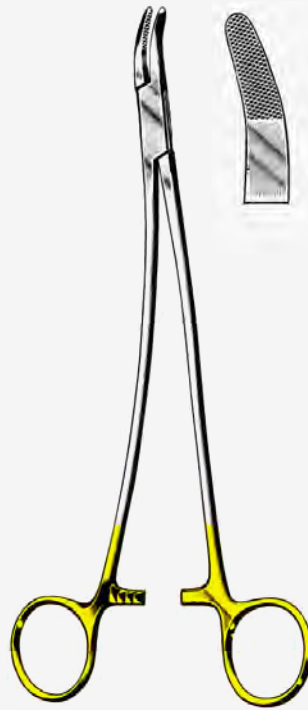

STRATTE

12-2494.23	23 cm, 9"
------------	-----------

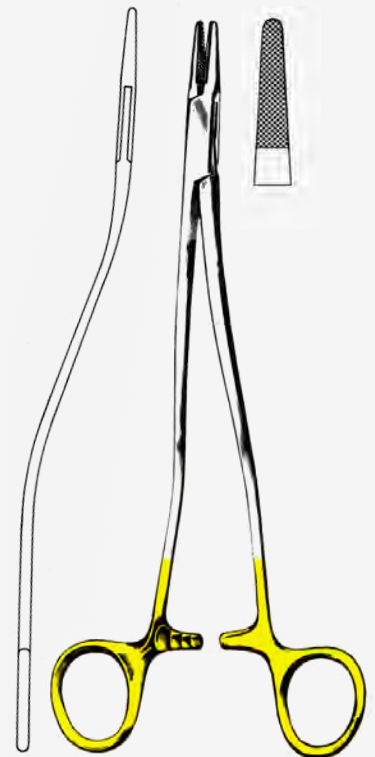

BOZEMANN

12-2477.20	20 cm, 8"
12-2477.24	24 cm, 9 1/2"
12-2477.26	26 cm, 10 1/4"

12

Nadelhalter mit Hartmetalleinlagen
Needle Holders with Tungsten Carbide Inserts
Porte-aiguilles avec mors en tungstène
Porta-agujas con bocas de carburo de tungsteno



MASSON

12-2468.27

27 cm, 10 3/4"



WANGENSTEEN

12-2472.27

27 cm, 10 3/4"

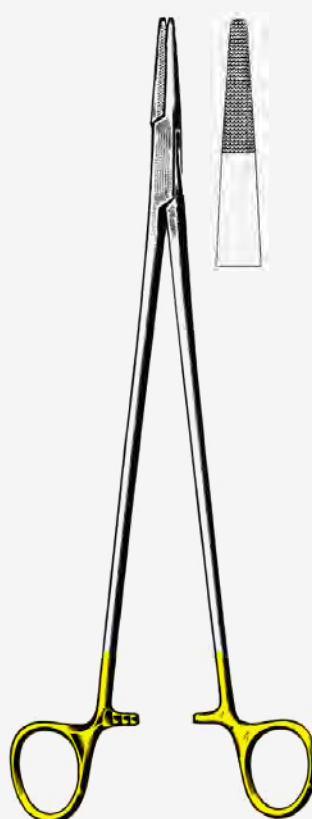

WANGENSTEEN

12-2476.27

27 cm, 10 3/4"



FINOCHIETTO

12-2487.20

20 cm, 8"

12-2487.27

27 cm, 10 3/4"



MATHIEU

12-2506.14	14 cm, 5 1/2"
12-2506.17	17 cm, 6 3/4"
12-2506.20	20 cm, 8"
12-2506.24	24 cm, 9 1/2"



MATHIEU

12-2510.17	17 cm, 6 3/4"
12-2510.20	20 cm, 8"



MATHIEU

12-2514.14	14 cm, 5 1/2"
12-2514.17	17 cm, 6 3/4"



OLSEN-HEGAR

12-2518.14	14 cm, 5 1/2"
12-2518.18	18 cm, 7"



OLSEN-HEGAR

12-2522.17	17 cm, 6 3/4"
------------	---------------

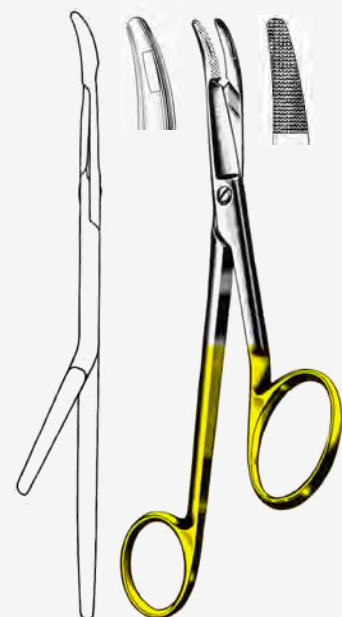

GILLIES

12-2528.16	16 cm, 6 1/4"
------------	---------------

12

Nadelhalter mit Hartmetalleinlagen
Needle Holders with Tungsten Carbide Inserts
 Porte-aiguilles avec mors en tungstène
 Porta-agujas con bocas de carburo de tungsteno



DIETRICH

12-2530.16	16 cm, 6 1/4"
12-2530.18	18 cm, 7"
12-2530.20	20 cm, 8"
12-2530.23	23 cm, 9"
12-2530.26	26 cm, 10 1/4"



ARRUGA

12-2540.16

16 cm, 6 1/4"



TOENNIS

12-2500.18

18 cm, 7"



BARRAQUER

12-2549.13

13 cm, 5"



CASTROVIEJO

12-2555.14

14 cm, 5 1/2"



CASTROVIEJO

12-2557.14

14 cm, 5 1/2"



CASTROVIEJO

12-2558.13

13 cm, 5"

Chapter 13

Table of Contents

Nahtinstrumente und Nähnadeln, Nahtbesteck, Sterilisationsinstrumente / **p. 154 - 156**

Suturing Instruments and Needles, Suturing Sets, Sterilizing Instruments / **p. 154 - 156**

Instruments et aiguilles à suture, instruments pour stérilisation / **p. 154 - 156**

Agujas e instrumentos de sutura, instrumentos para esterilización / **p. 154 - 156**





13

Unterbindungsnaedeln
Ligature Needles
 Aiguilles à ligatures
 Agujas para ligaduras

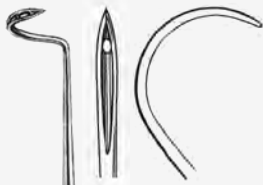

für die rechte Hand, scharf
 for the right hand, sharp
 pour la main droite, pointue
 para la mano derecha, aguda

13-0721.21	21 cm, 8 1/4"
13-0721.24	24 cm, 9 1/2"
13-0721.27	27 cm, 10 1/2"

DESCHAMPS

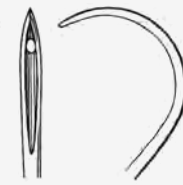

für die linke Hand, scharf
 for the left hand, sharp
 pour la main gauche, pointue
 para la mano izquierda, aguda

13-0723.21	21 cm, 8 1/4"
13-0723.24	24 cm, 9 1/2"
13-0723.27	27 cm, 10 1/2"

DESCHAMPS

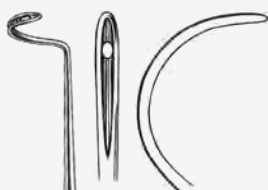

für die rechte Hand, stumpf
 for the right hand, blunt
 pour la main droite, mousse
 para la mano derecha, roma

13-0725.21	21 cm, 8 1/4"
13-0725.24	24 cm, 9 1/2"
13-0725.27	27 cm, 10 1/2"

DESCHAMPS

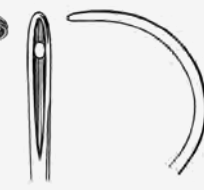

für die linke Hand, stumpf
 for the left hand, blunt
 pour la main gauche, mousse
 para la mano izquierda, roma

13-0727.21	21 cm, 8 1/4"
13-0727.24	24 cm, 9 1/2"
13-0727.27	27 cm, 10 1/2"

DESCHAMPS



KRONECKER

13-0714.13

13 cm, 5"



KRONECKER

13-0715.13

13 cm, 5"



COOPER

13-0765.19

19 cm, 7 1/2"



NELSON

13-0717.24

24,5 cm, 9 3/4"



NELSON

13-0718.24

24,5 cm, 9 3/4"



YOUNG

13-1027.00

25 cm, 10"



13-1027.01

Fig. 1



13-1027.02

Fig. 2



13-1027.03

Fig. 3

13

Unterbindungsnadeln
Ligature Needles
 Aiguilles à ligatures
 Agujas para ligaduras



REVERDIN

Fig. 1



13-1015.01
 15 cm, 6"

Fig. 2



13-1015.02
 15 cm, 6"

Fig. 3



13-1015.03
 15 cm, 6"

Fig. 4



13-1015.04
 15 cm, 6"



REVERDIN

Fig. 1



13-1019.01
13-1021.01
13-1023.01

Fig. 2



13-1019.02
13-1021.02
13-1023.02

Fig. 3



13-1019.03
13-1021.03
13-1023.03

Fig. 4



13-1019.04 19,5 cm, 7 3/4"
13-1021.04 21 cm, 8 1/4"
13-1023.04 22,5 cm, 8 3/4"



SCHMIEDEN

13-2068.19

19 cm, 7 1/2"



SCHMIEDEN-PAYR

13-2069.19

19 cm, 7 1/2"



PAYR

13-2110.22

22 cm, 8 3/4"



PAYR

13-2111.22

22 cm, 8 3/4"



KOENIG

13-2089.20

20 cm, 8"

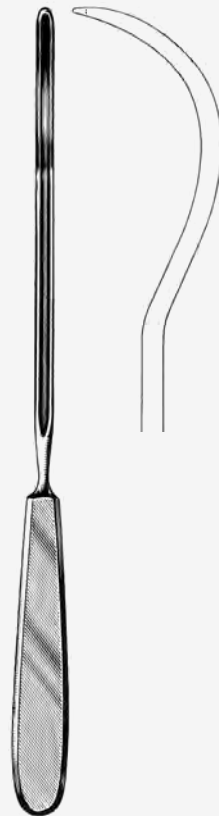

KIRSCHNER

13-2035.25

25,5 cm, 10"



BRUNNER

13-2030.01

30 cm, 12"

Kunststoff
 Plastic Material
 Matière plastique
 Materia plástica



BRUNNER

13-2125.18

18 cm, 7"

13-2125.27

27 cm, 10 1/2"

alle Nadeln mit Federöhr
 all the needles with spring eye
 toutes les aiguilles à chas à ressort
 todas la agujas con ojo de resorte

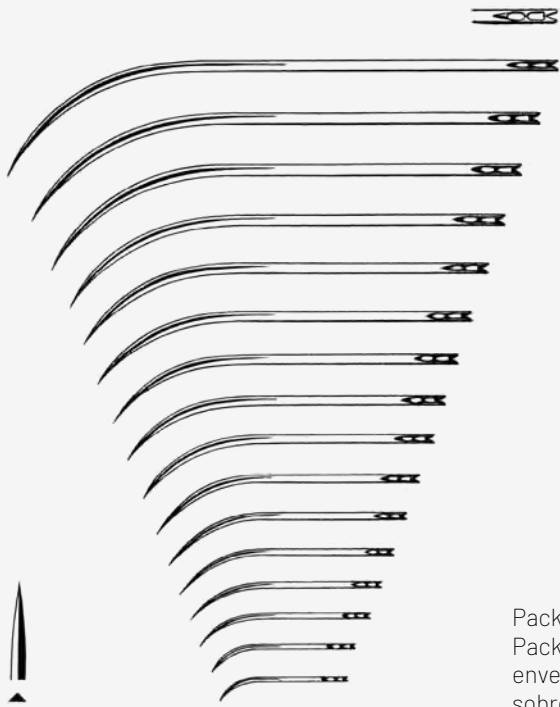

Packung 1 Dutzend
 Package 1 dozen
 enveloppe 1 douzaine
 sobre 1 dozena

13-8010.01	Fig.1
13-8010.02	Fig.2
13-8010.03	Fig.3
13-8010.04	Fig.4
13-8010.05	Fig.5
13-8010.06	Fig.6
13-8010.07	Fig.7
13-8010.08	Fig.8
13-8010.09	Fig.9
13-8010.10	Fig.10
13-8010.11	Fig.11
13-8010.12	Fig.12
13-8010.13	Fig.13
13-8010.14	Fig.14
13-8010.15	Fig.15
13-8010.16	Fig.16

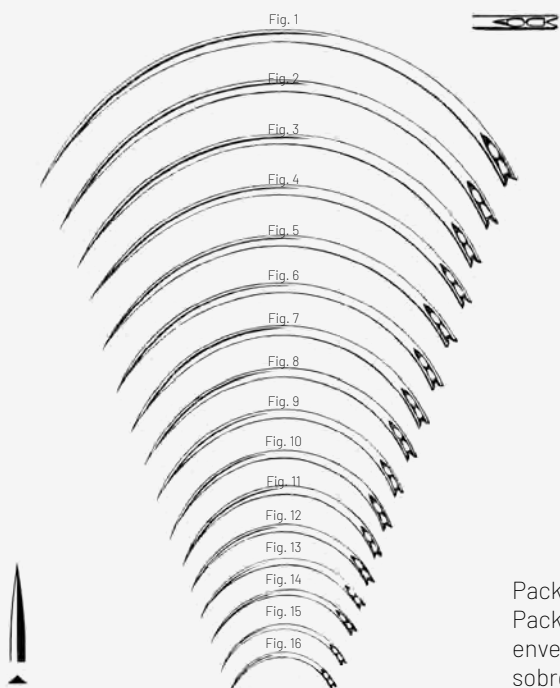

Packung 1 Dutzend
 Package 1 dozen
 enveloppe 1 douzaine
 sobre 1 dozena

13-8011.01	Fig.1
13-8011.02	Fig.2
13-8011.03	Fig.3
13-8011.04	Fig.4
13-8011.05	Fig.5
13-8011.06	Fig.6
13-8011.07	Fig.7
13-8011.08	Fig.8
13-8011.09	Fig.9
13-8011.10	Fig.10
13-8011.11	Fig.11
13-8011.12	Fig.12
13-8011.13	Fig.13
13-8011.14	Fig.14
13-8011.15	Fig.15
13-8011.16	Fig.16

alle Nadeln mit Federöhr
 all the needles with spring eye
 toutes les aiguilles à chas à ressort
 todas la agujas con ojo de resorte

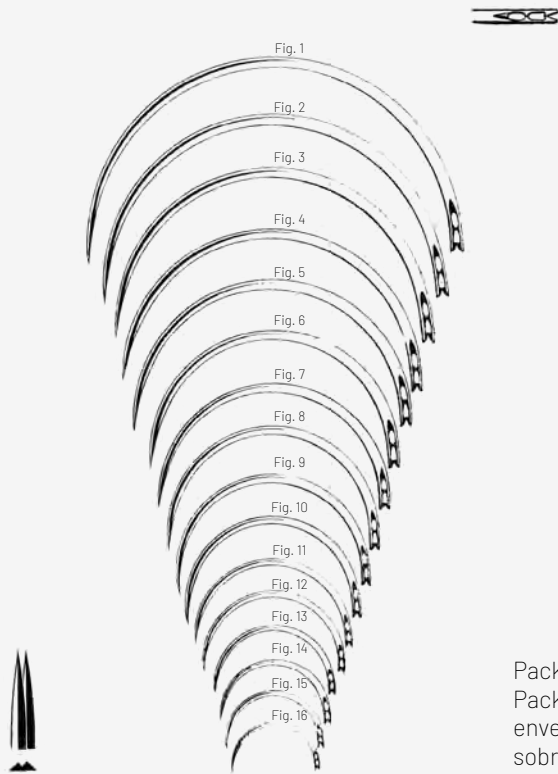

Packung 1 Dutzend
 Package 1 dozen
 enveloppe 1 douzaine
 sobre 1 dozana

13-8012.01	Fig.1
13-8012.02	Fig.2
13-8012.03	Fig.3
13-8012.04	Fig.4
13-8012.05	Fig.5
13-8012.06	Fig.6
13-8012.07	Fig.7
13-8012.08	Fig.8
13-8012.09	Fig.9
13-8012.10	Fig.10
13-8012.11	Fig.11
13-8012.12	Fig.12
13-8012.13	Fig.13
13-8012.14	Fig.14
13-8012.15	Fig.15
13-8012.16	Fig.16

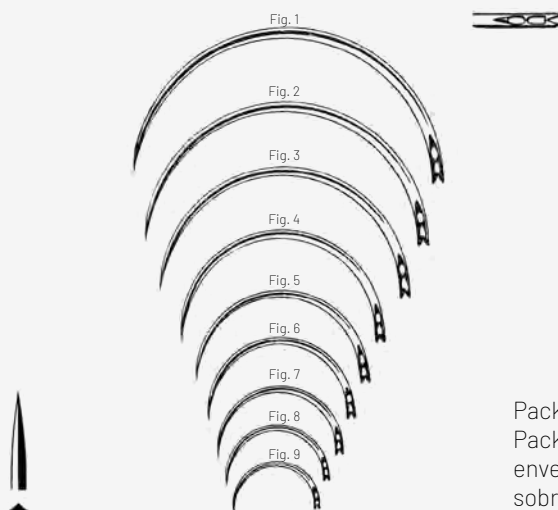

Packung 1 Dutzend
 Package 1 dozen
 enveloppe 1 douzaine
 sobre 1 dozana

13-8013.01	Fig.1
13-8013.02	Fig.2
13-8013.03	Fig.3
13-8013.04	Fig.4
13-8013.05	Fig.5
13-8013.06	Fig.6
13-8013.07	Fig.7
13-8013.08	Fig.8
13-8013.09	Fig.9

alle Nadeln mit Federöhr
 all the needles with spring eye
 toutes les aiguilles à chas à ressort
 todas la agujas con ojo de resorte

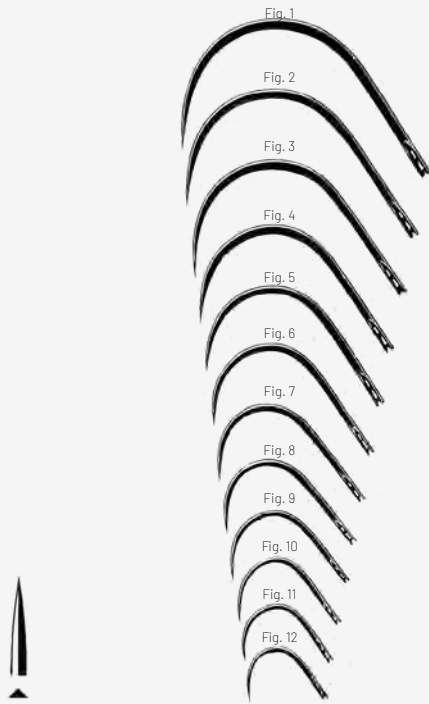

Packung 1 Dutzend
 Package 1 dozen
 enveloppe 1 douzaine
 sobre 1 dozena

KOENIG	
13-8015.01	Fig.1
13-8015.02	Fig.2
13-8015.03	Fig.3
13-8015.04	Fig.4
13-8015.05	Fig.5
13-8015.06	Fig.6
13-8015.07	Fig.7
13-8015.08	Fig.8
13-8015.09	Fig.9
13-8015.10	Fig.10
13-8015.11	Fig.11
13-8015.12	Fig.12

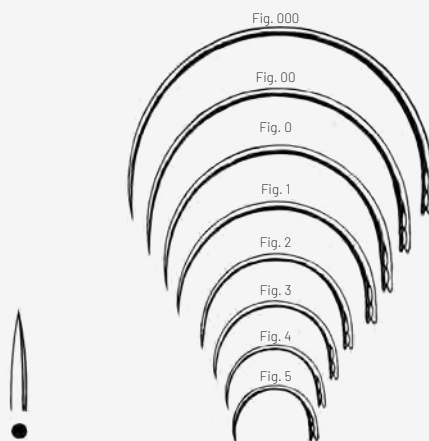

Packung 1 Dutzend
 Package 1 dozen
 enveloppe 1 douzaine
 sobre 1 dozena

13-8016.30	Fig.000
13-8016.20	Fig.00
13-8016.10	Fig.0
13-8016.01	Fig.1
13-8016.02	Fig.2
13-8016.03	Fig.3
13-8016.04	Fig.4
13-8016.05	Fig.5

alle Nadeln mit Federöhr
 all the needles with spring eye
 toutes les aiguilles à chas à ressort
 todas la agujas con ojo de resorte

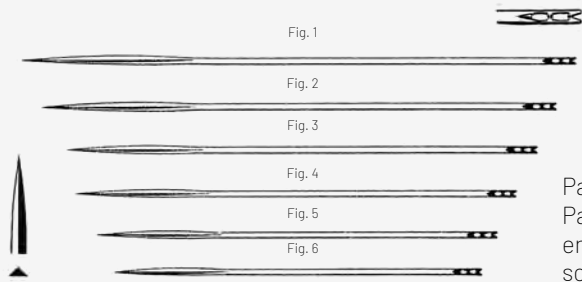

Packung 1 Dutzend
 Package 1 dozen
 enveloppe 1 douzaine
 sobre 1 dozana

KEITH	
13-8018.01	Fig.1
13-8018.02	Fig.2
13-8018.03	Fig.3
13-8018.04	Fig.4
13-8018.05	Fig.5
13-8018.06	Fig.6

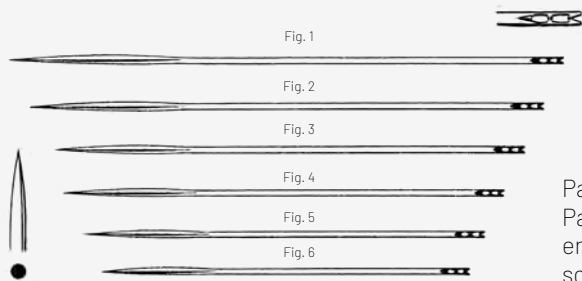

Packung 1 Dutzend
 Package 1 dozen
 enveloppe 1 douzaine
 sobre 1 dozana

KEITH	
13-8020.01	Fig.1
13-8020.02	Fig.2
13-8020.03	Fig.3
13-8020.04	Fig.4
13-8020.05	Fig.5
13-8020.06	Fig.6

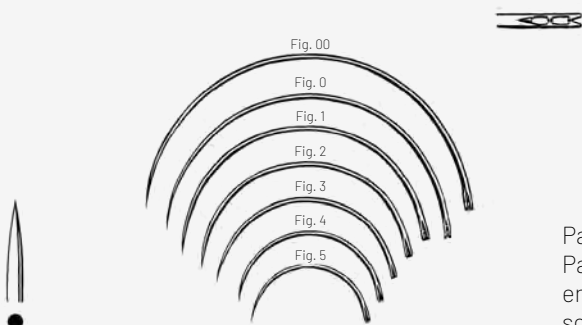

Packung 1 Dutzend
 Package 1 dozen
 enveloppe 1 douzaine
 sobre 1 dozana

13-8021.20	Fig.00
13-8021.10	Fig.0
13-8021.01	Fig.1
13-8021.02	Fig.2
13-8021.03	Fig.3
13-8021.04	Fig.4
13-8021.05	Fig.5

alle Nadeln mit Federöhr
 all the needles with spring eye
 toutes les aiguilles à chas à ressort
 todas la agujas con ojo de resorte

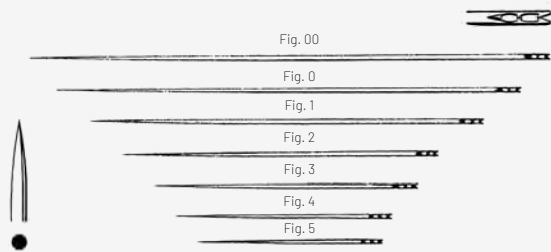

Packung 1 Dutzend
 Package 1 dozen
 enveloppe 1 douzaine
 sobre 1 dozana

13-8022.20	Fig.00
13-8022.10	Fig.0
13-8022.01	Fig.1
13-8022.02	Fig.2
13-8022.03	Fig.3
13-8022.04	Fig.4
13-8022.05	Fig.5

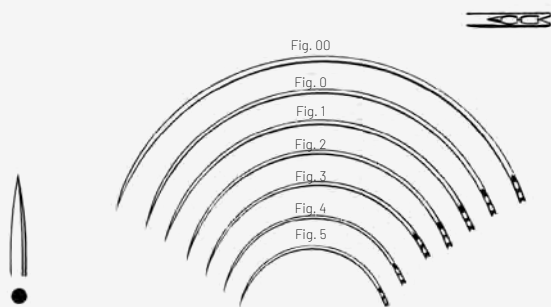

Packung 1 Dutzend
 Package 1 dozen
 enveloppe 1 douzaine
 sobre 1 dozana

13-8023.20	Fig.00
13-8023.10	Fig.0
13-8023.01	Fig.1
13-8023.02	Fig.2
13-8023.03	Fig.3
13-8023.04	Fig.4
13-8023.05	Fig.5



MICHEL

13-5720.12

12 cm, 4 3/4"



WACHENFELDT

13-5730.12

12 cm, 4 3/4"



WACHENFELDT

13-5732.12

12 cm, 4 3/4"



HEGENBARTH

13-5734.12

12,5 cm, 5"



CHILDE

13-5711.18

18 cm, 7"



MICHEL

13-9060.12

12 cm, 4 3/4"



MICHEL

13-9061.13

13 cm, 5"

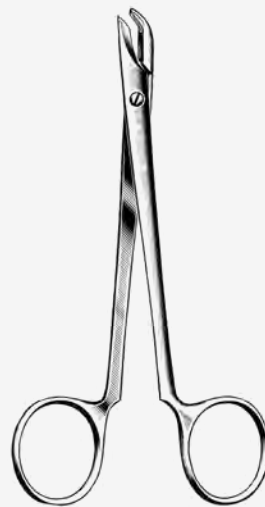

COLLIN

13-9067.13

13 cm, 5"



RICHTER-HEATH

13-9069.14

14 cm, 5 1/2"



MICHEL

13-9510.07	7,5 x 1,75 mm
13-9510.11	11 x 2 mm
13-9510.12	12 x 3 mm
13-9510.14	14 x 3 mm
13-9510.16	16 x 3 mm
13-9510.18	18 x 3 mm
13-9510.20	20 x 3 mm
13-9510.22	22 x 3 mm



WACHENFELDT

13-9010.12	12 x 3 mm
13-9010.14	14 x 3 mm
13-9010.16	16 x 3 mm
13-9010.18	18 x 3 mm
13-9010.20	20 x 3 mm



13-9500.00

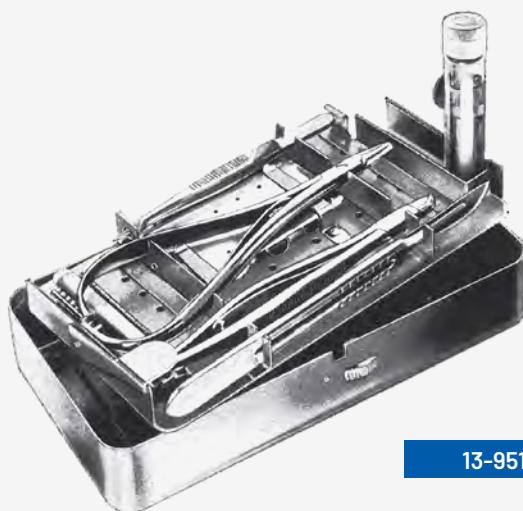

13-9514.60

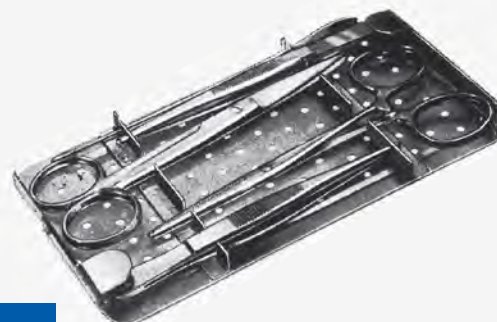



DAVIS

13-5821.16	16 cm, 6 3/4"
13-5821.20	20 cm, 8"
13-5821.24	24 cm, 9 1/2"

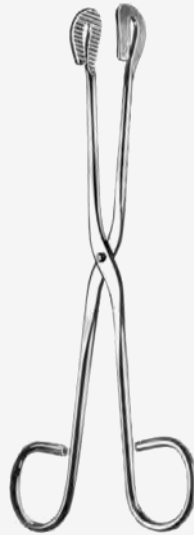

UNIVERSAL

13-9956.20	20 cm, 8"
13-9956.28	28 cm, 11"

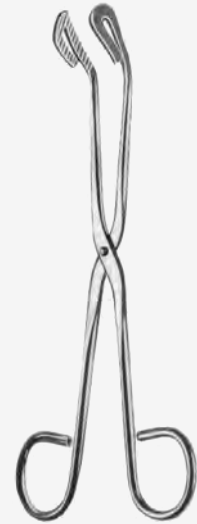

UNIVERSAL

13-9957.20	20 cm, 8"
13-9957.28	28 cm, 11"



CHEATTLE

13-9955.27	27 cm, 10 1/2"
-------------------	----------------

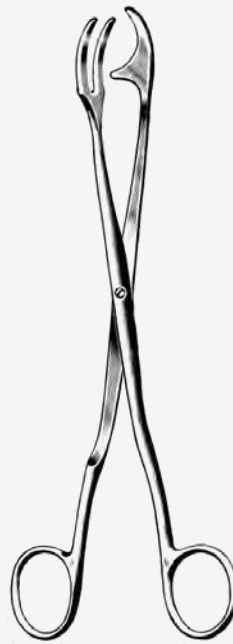

ROGGE

13-9954.23	23 cm, 9"
-------------------	-----------



13-9952.20

13-9952.20	20 cm, 8"
13-9952.30	30 cm, 12"



BUNT

13-9960.12

12 cm, 4 1/4"

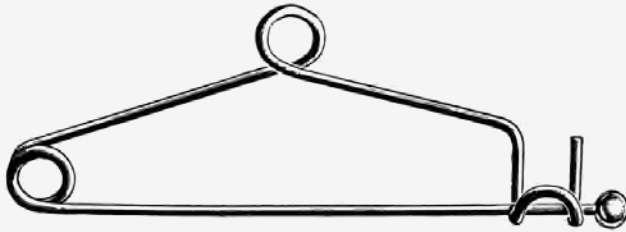

MAYO

13-9962.14

14 cm, 5 1/2"

Chapter 14

Table of Contents

Gipsverband, Elektrische Gipssäge / **p. 200 - 204**

Plaster of Paris, Electric Plaster Cast Cutter / **p. 200 - 204**

Appareil plâtres, scie électric / **p. 200 - 204**

Vendajes enyesados, sierra eléctrica para yesos / **p. 200 - 204**







STILLE

14-0620.24

24 cm, 9 1/2"



STILLE

14-0600.23

23 cm, 9"

14-0600.26

26 cm, 10 1/4"

14-0600.37

37 cm, 14 1/2"



WIGMORE

14-0622.19

19 cm, 7 1/2"

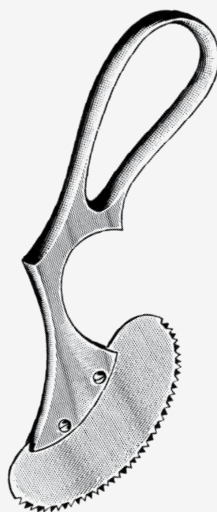

ENGEL

14-0710.14

14 cm, 5 1/2"

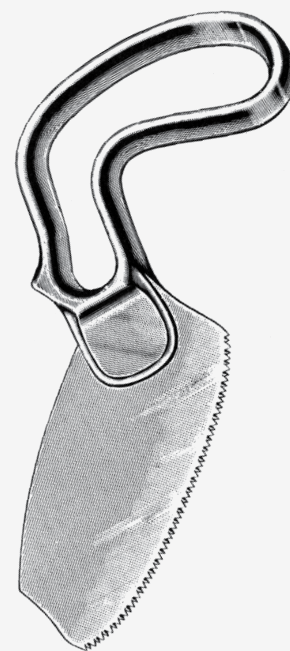

BERGMANN

14-0712.18

18 cm, 7"



HAGLUND-STILLE
 14-0920.28
 28 cm, 11"



BEESON
 14-0922.30
 30 cm, 11³/₄"



HENNIG
 14-0924.28
 28 cm, 11"



MOD. USA
 14-0930.23
 23 cm, 9"



HOPKINS
 14-0932.20
 20 cm, 8"



ESMARCH
 14-0934.18
 18 cm, 7"



REINER
 14-0936.18
 18 cm, 7"



WOLFF
 14-0953.18
 18 cm, 7"



WOLFF
 14-0953.24
 24 cm, 9 1/2"

14

Elektrische Gipssäge
Electric Plaster Cast Cutter
 Scie électrique à plâtre
 Sierra eléctrica para yesos



14-0810.11	110 V
14-0810.22	220 V



14-0810.50	Ø 50 mm
14-0810.65	Ø 65 mm



14-0811.50	Ø 50 mm
14-0811.65	Ø 65 mm

spezialgehärtet
 special hardness
 acier trempé
 templada especial



14-0812.13

Chapter 15

Table of Contents

Hohlmeißelzangen, Knochensplitter- und -halte-zangen, Knochenchirurgie / **p. 206 - 246**

Bone Rongeurs, Bone Cutting Forceps, Bone Holding Forceps, Bone Surgery / **p. 206 - 246**

Pincès gouges, pinces coupantes à os, daviers porte-os, chirurgie osseuse / **p. 206 - 246**

Pinzas-gubias, pinzas cortantes para huesos, cirugía ósea / **p. 206 - 246**







MINI-FRIEDMANN

15-0531.12

12 cm, 4 3/4"



MINI-FRIEDMANN

15-0533.14

14 cm, 5 1/2"



90°

FRIEDMANN

15-0535.90

14 cm, 5 1/2"



FRIEDMANN

15-0540.15

15 cm, 5 3/4"



CLEVELAND

15-0544.14

14 cm, 5 1/2"



CLEVELAND

15-0544.17

17 cm, 6 3/4"



MEAD

15-0561.17

16,5 cm, 6 1/2"



MEAD

15-0563.16

16,5 cm, 6 1/2"



BLUMENTHAL
 15-0576.30
 15,5 cm, 6"



BLUMENTHAL
 15-0576.45
 15,5 cm, 6"



BLUMENTHAL
 15-0576.90
 15,5 cm, 6"



LUER
 15-0655.01
 15 cm, 5 3/4"



LUER
 15-0655.02
 15 cm, 5 3/4"



LUER



15-0650.17
 17 cm, 6 3/4"



15-0651.17
 17 cm, 6 3/4"



OLIVECRONA
 15-0677.20
 20 cm, 8"



ADSON



15-0670.20
 20 cm, 8"



15-0671.20
 20 cm, 8"



LEMPERT



15-0636.16
 16 cm, 6 1/4"



15-0637.16
 16 cm, 6 1/4"



15-0638.18
 18,5 cm, 7 1/4"



15-0639.18
 18,5 cm, 7 1/4"



BEYER
15-1011.18
 18 cm, 7"



ZAUFAL-JANSEN
15-1013.18
 18 cm, 7"



RUSKIN
15-1055.23
 23 cm, 9"



15-1000.15

15 cm, 5 3/4"



15-1001.15

15 cm, 5 3/4"



15-1050.18

18 cm, 7"



15-1051.18

18 cm, 7"

BÖHLER

RUSKIN

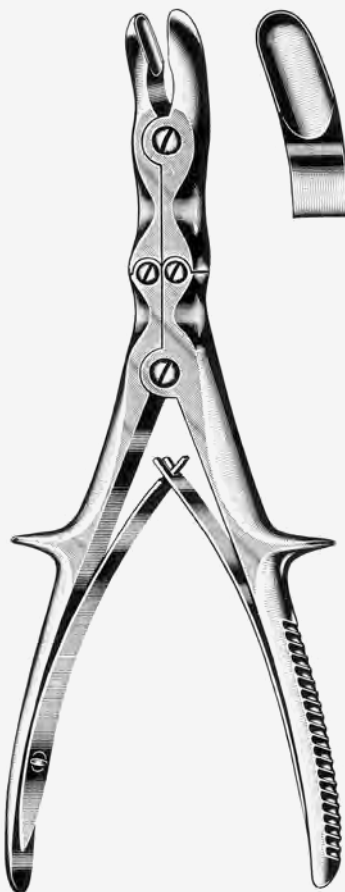

STILLE-RUSKIN

15-1061.23

23 cm, 9"



STILLE-LUER

15-1065.23

23 cm, 9"



ECHLIN

15-1133.31

23 cm, 9"

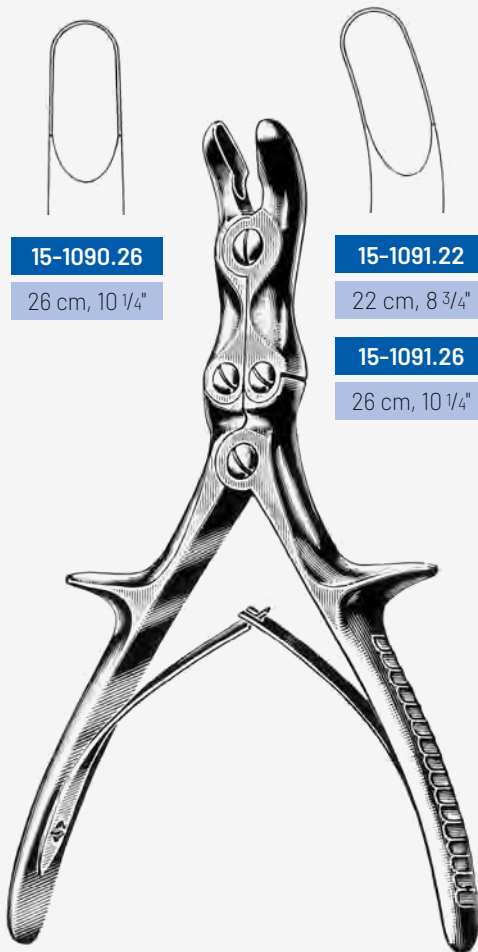

15-1090.26
 26 cm, 10 1/4"

15-1091.22
 22 cm, 8 3/4"

15-1091.26
 26 cm, 10 1/4"

STILLE-LUER

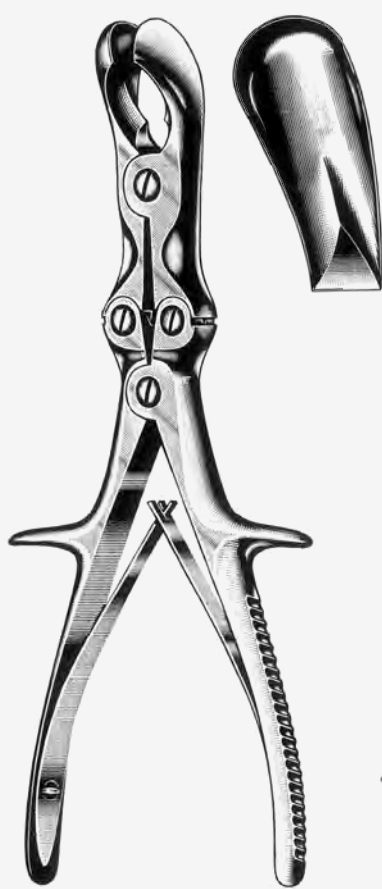

SEMB
15-1095.23
 23 cm, 9"



FRYKHOLM
15-1135.24
 24 cm, 9 1/2"

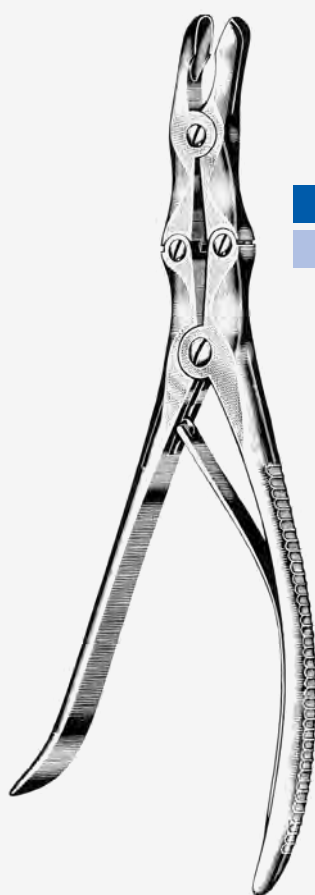

LEKSELL

Fig.1



15-1128.05
23 cm, 9"

Fig.2



15-1128.08
23 cm, 9"



SAUERBRUCH

Fig.1



15-1162.21
30 cm, 12"

Fig.2



15-1163.21
30 cm, 12"

15

Knochensplitterzangen
Bone Cutting Forceps
 Pinces coupantes à os
 Pinzas cortantes para huesos



15-0150.14	14 cm, 5 1/2"	15-0151.14
15-0150.17	17 cm, 6 3/4"	15-0151.17
15-0150.19	19 cm, 7 1/2"	15-0151.19
15-0150.22	22 cm, 8 3/4"	15-0151.22

LISTON



15-0200.15	15 cm, 6"	15-0201.15	15 cm, 6"
------------	-----------	------------	-----------

BÖHLER



COTTLE-KAZANJIAN
 15-0110.19
 19 cm, 7 1/2"



RUSKIN-LISTON

15-0210.19
 18,5 cm, 7 1/4"



15-0211.19
 18,5 cm, 7 1/4"

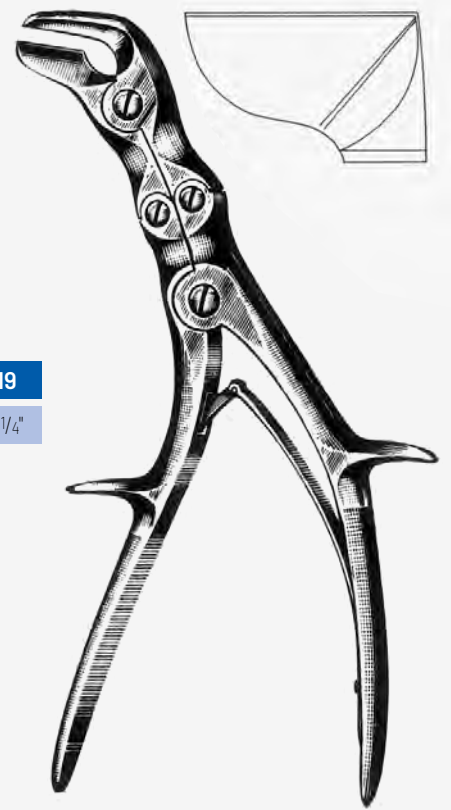

SEMB
 15-0307.23
 24 cm, 9 1/2"

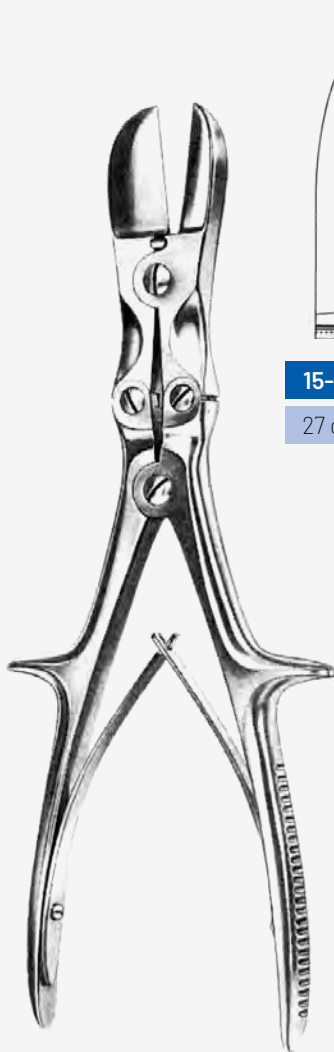

15-0300.27
27 cm, 10 1/4"



15-0301.27
27 cm, 10 1/4"

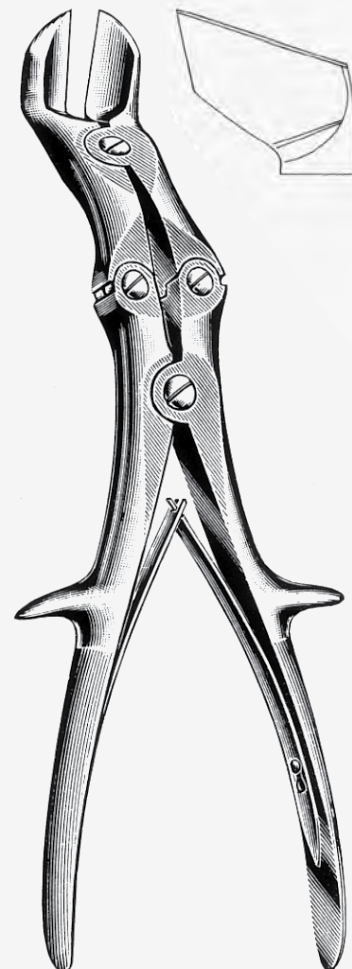

LISTON-KEY-HORSLEY
15-0305.27
27 cm, 10 3/4"

STILLE-LISTON

15

Knochenhalte­zangen
Bone Holding Forceps
 Daviers porte-os
 Pinzas para agarrar huesos



FERGUSSON

15-2150.21

21 cm, 8 1/4"



LANGENBECK

15-2152.21

21 cm, 8 1/4"

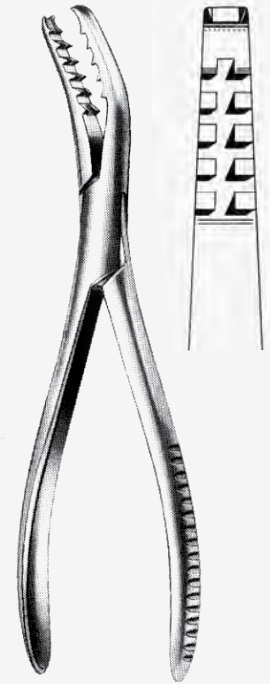

SEMB

15-2131.19

19 cm, 7 1/2"



FARABEUF

15-2313.23

23 cm, 9"

15-2313.26

26 cm, 10 1/4"



FARABEUF-LAMBOTTE

15-2315.26

26 cm, 10 1/4"



LAMBOTTE

15-2320.22

22 cm, 8 3/4"

15-2320.27

27 cm, 10 1/2"

15-2320.30

30 cm, 12"



LAMBOTTE

15-2330.22	22 cm, 8 3/4"
15-2330.26	26 cm, 10 1/4"
15-2330.33	33 cm, 13"



LAMBOTTE

15-2331.19	19 cm, 7 1/2"
15-2331.23	23 cm, 9"
15-2331.26	26 cm, 10 1/4"

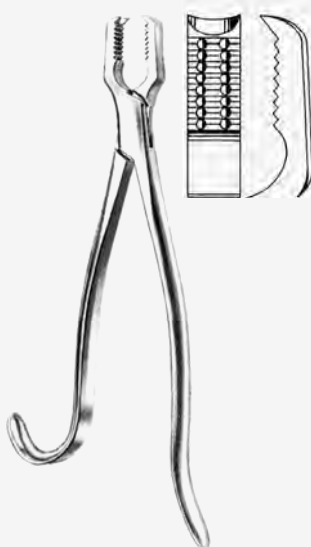

KERN

15-2340.15	15 cm, 5 3/4"
15-2340.17	17 cm, 6 3/4"
15-2340.21	21 cm, 8 1/4"

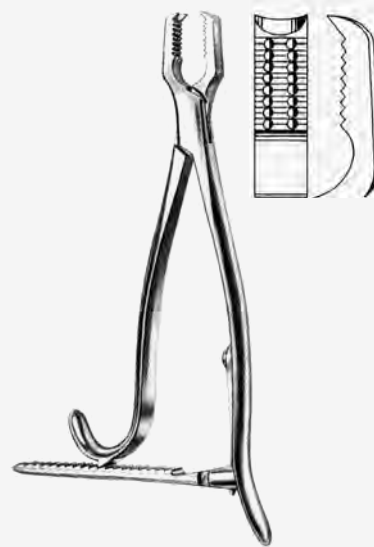

KERN

15-2342.15	15 cm, 5 3/4"
15-2342.17	17 cm, 6 3/4"
15-2342.21	21 cm, 8 1/4"



LANE

15-2360.33	33 cm, 13"
15-2360.45	45 cm, 17"



LANE

15-2362.33	33 cm, 13"
15-2362.45	45 cm, 17"

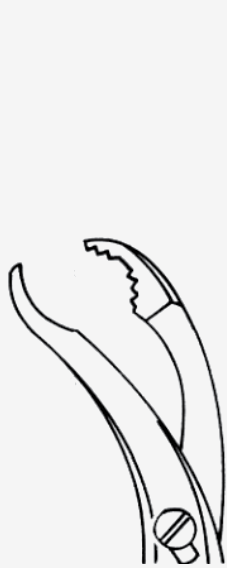

15-2205.15

15 cm, 6"

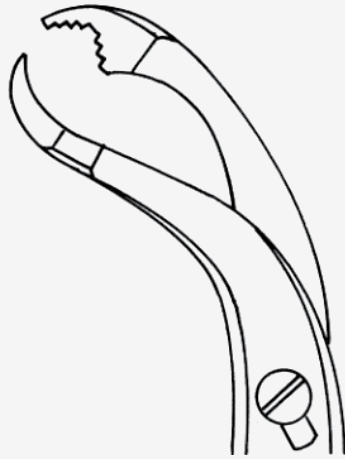

15-2205.19

19 cm, 7 1/2"

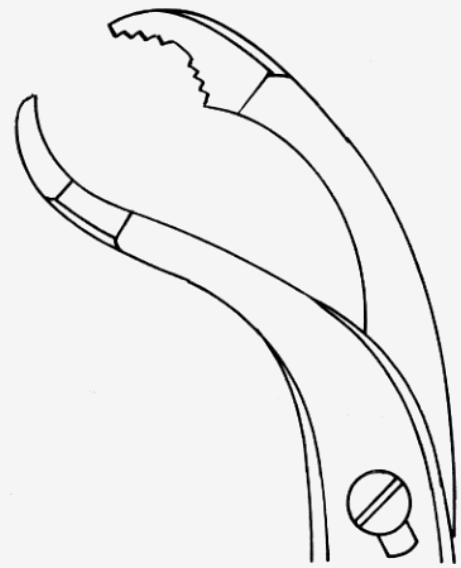

15-2205.24

24 cm, 9 1/2"

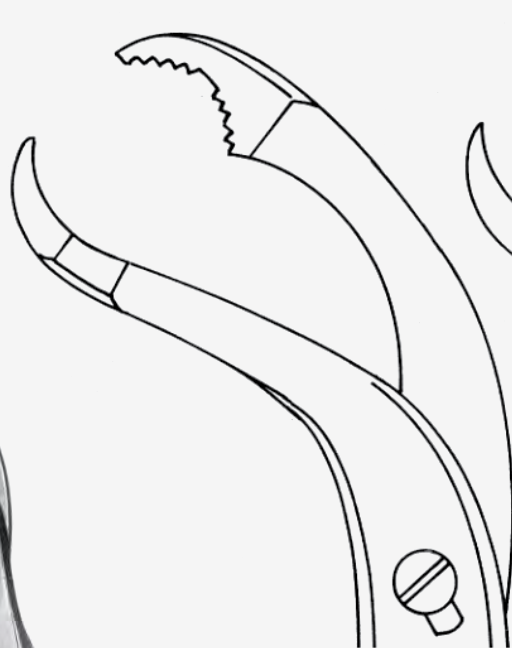

15-2205.26

26 cm, 10 1/4"

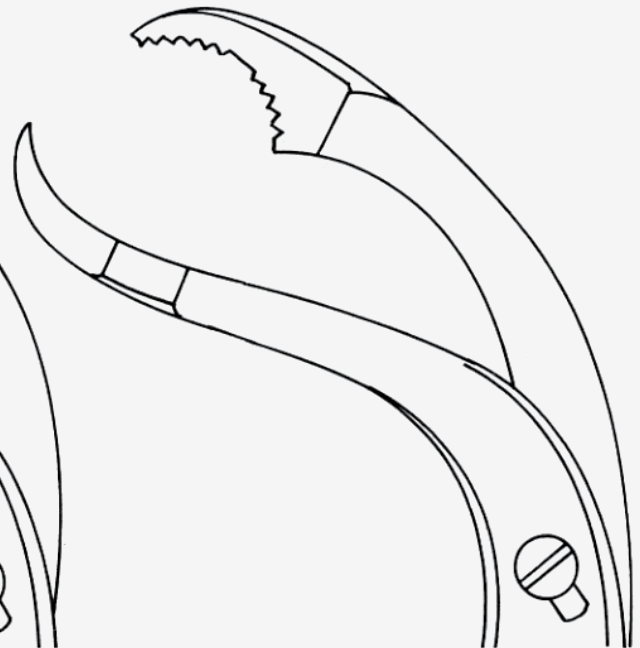

15-2205.28

28 cm, 11"



15

Knochenhalte-, Sequesterzangen
Bone Holding Forceps, Sequester Forceps
 Daviers porte-os, à séquestres
 Pinzas para huesos y secuestros



VERBRUGGE

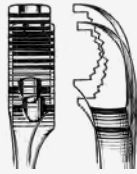

15-2200.15
15 cm, 6"

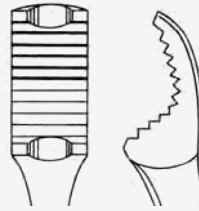

15-2200.25
25 cm, 10"

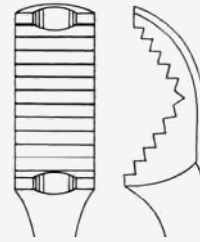

15-2200.26
26 cm, 10 1/2"

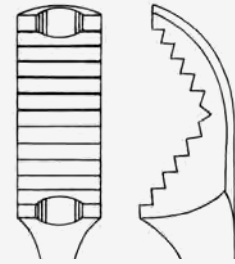

15-2200.27
27 cm, 11"

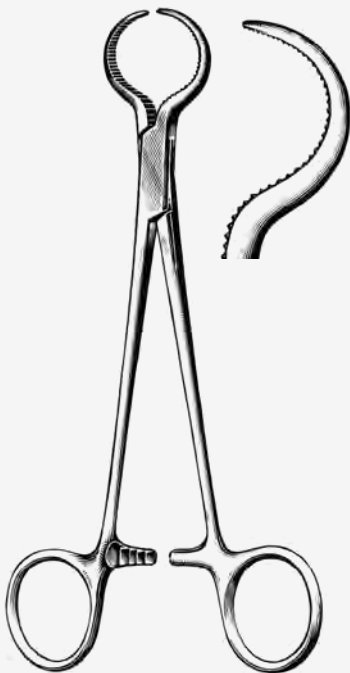

LEWIN
15-2039.17
17,5 cm, 7"



BIRCHER-GANSKE
15-2002.20
20 cm, 8"



BIRCHER-GANSKE
15-2003.20
20 cm, 8"

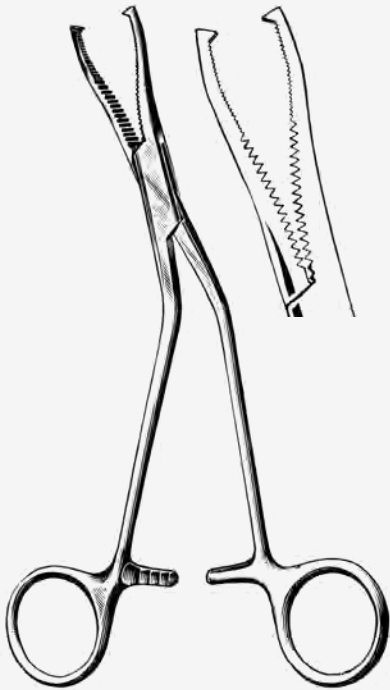

DINGMAN

15-2035.19

19 cm, 7 1/2"



15-2041.13

13,5 cm, 5 1/4"



MARTIN

15-2008.19

19 cm, 7 1/2"



15-2084.20

20 cm, 8"



15-2085.20

20 cm, 8"



VAN BUREN

15-2091.23

23 cm, 9"



LOWMANN

15-2410.13	13 cm, 5"
15-2410.18	18,5 cm, 7 1/4"
15-2410.20	20 cm, 8"

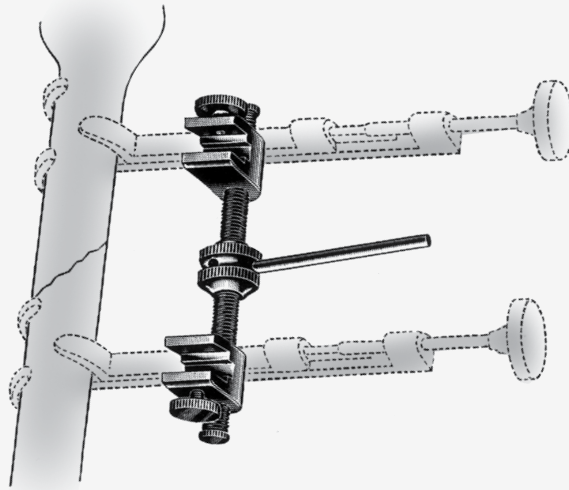

GERSTER

15-2400.15

15 cm, 5 3/4"



PARHAM

15-2401.00

18 cm, 7"



PARHAM

15-2401.18

18 cm, 7"

15-2401.30

30 cm, 12"



15-2402.01

für Erwachsene
 for adults
 pour adultes
 para adultos

15-2402.02

für Kinder
 for children
 pour enfants
 para niños



SCHEDE

17 cm, 6³/₄"

15-2017.33	Fig. 000
15-2017.42	Fig. 00
15-2017.50	Fig. 0
15-2017.51	Fig. 1
15-2017.52	Fig. 2
15-2017.53	Fig. 3
15-2017.54	Fig. 4

VOLKMANN

17 cm, 6³/₄"

15-2027.24	Fig. 0000
15-2027.33	Fig. 000
15-2027.42	Fig. 00
15-2027.50	Fig. 0
15-2027.51	Fig. 1
15-2027.52	Fig. 2
15-2027.53	Fig. 3
15-2027.54	Fig. 4
15-2027.55	Fig. 5
15-2027.56	Fig. 6

BRUNS

17 cm, 6³/₄"

15-2037.24	Fig. 0000
15-2037.33	Fig. 000
15-2037.42	Fig. 00
15-2037.50	Fig. 0
15-2037.51	Fig. 1
15-2037.52	Fig. 2
15-2037.53	Fig. 3
15-2037.54	Fig. 4
15-2037.55	Fig. 5
15-2037.56	Fig. 6

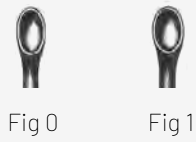
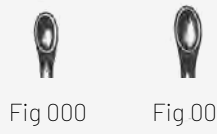

SPRATT

16 cm, 6 1/4"

15-2046.33	Fig. 000
15-2046.42	Fig. 00
15-2046.50	Fig. 0
15-2046.51	Fig. 1
15-2046.52	Fig. 2
15-2046.53	Fig. 3
15-2046.54	Fig. 4
15-2046.55	Fig. 5
15-2046.56	Fig. 6

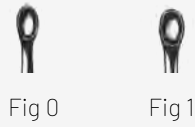
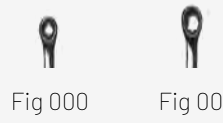

BRUNS

23 cm, 9"

15-2096.33	Fig. 000
15-2096.42	Fig. 00
15-2096.50	Fig. 0
15-2096.51	Fig. 1
15-2096.52	Fig. 2
15-2096.53	Fig. 3
15-2096.54	Fig. 4
15-2096.55	Fig. 5
15-2096.56	Fig. 6



SIMON

24 cm, 9 1/2"

15-2144.51	Fig. 1
15-2144.52	Fig. 2
15-2144.53	Fig. 3
15-2144.54	Fig. 4
15-2144.55	Fig. 5
15-2144.56	Fig. 6



LEMPERT
 21 cm, 8 1/4"

15-2171.15	Fig. 00000
15-2171.24	Fig. 0000
15-2171.33	Fig. 000
15-2171.42	Fig. 00
15-2171.50	Fig. 0
15-2171.51	Fig. 1



HALLE
 21 cm, 8 1/4"

15-2151.01	Fig. 1
15-2151.02	Fig. 2
15-2151.03	Fig. 3



VOLKMANN

15-2314.13	13 cm, 5"
15-2314.16	16 cm, 6 1/4"
15-2314.20	20 cm, 8"



VOLKMANN

15-2310.13	13 cm, 5"
15-2310.14	14 cm, 5 1/2"
15-2310.17	17 cm, 6 3/4"

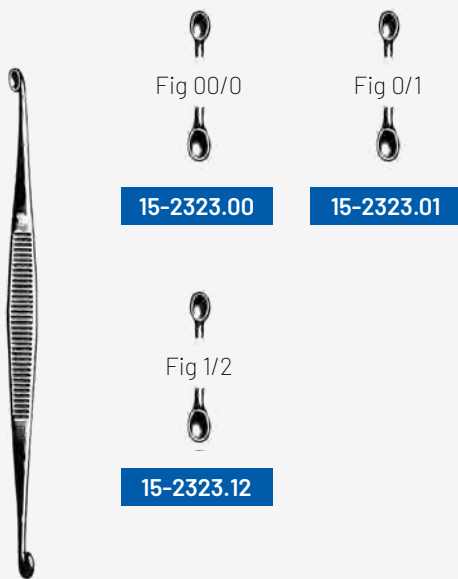

WILLIGER

13,5 cm, 5 1/4"

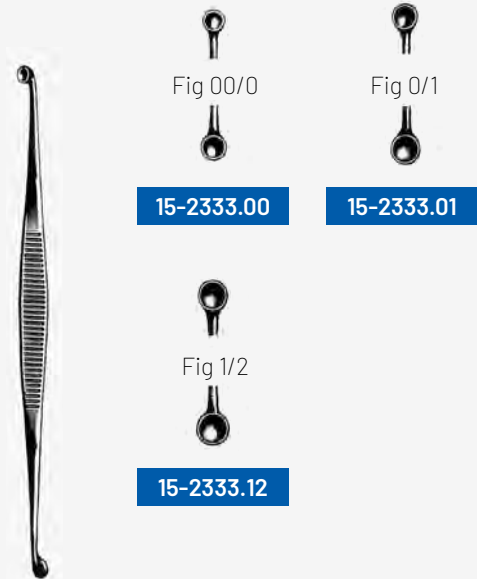

MARTINI

13,5 cm, 5 1/4"



Osteotome
 Osteotomes
 Ostéotomes
 Osteótomos

15-1020.08	8 mm
15-1020.10	10 mm
15-1020.12	12 mm
15-1020.14	14 mm
15-1020.16	16 mm

13,5 cm, 5 1/4"



Flachmeißel
 Chisels
 Ciseaux-burins
 Cinceles

15-1022.08	8 mm
15-1022.10	10 mm
15-1022.12	12 mm
15-1022.14	14 mm
15-1022.16	16 mm

13,5 cm, 5 1/4"



Hohlmeißel
 Gouges
 Gouges
 Gubias

15-1024.08	8 mm
15-1024.10	10 mm
15-1024.12	12 mm
15-1024.14	14 mm
15-1024.16	16 mm

13,5 cm, 5 1/4"



Flachmeißel
 Chisels
 Ciseaux-burins
 Cinceles

15-1112.04	4 mm
15-1112.06	6 mm
15-1112.08	8 mm
15-1112.10	10 mm
15-1112.12	12 mm
15-1112.14	14 mm

ALEXANDER

17 cm, 6 3/4"



Hohlmeißel
 Gouges
 Gouges
 Gubias

15-1114.04	4 mm
15-1114.06	6 mm
15-1114.08	8 mm
15-1114.10	10 mm
15-1114.12	12 mm
15-1114.14	14 mm

ALEXANDER

17 cm, 6 3/4"



Flachmeißel
 Chisels
 Ciseaux-burins
 Cinceles

15-1062.02	2 mm
15-1062.03	3 mm
15-1062.04	4 mm
15-1062.05	5 mm
15-1062.06	6 mm
15-1062.07	7 mm
15-1062.08	8 mm

PARTSCH

13,5 cm, 5 1/4"



Hohlmeißel
 Gouges
 Gouges
 Gubias

15-1064.02	2 mm
15-1064.03	3 mm
15-1064.04	4 mm
15-1064.05	5 mm
15-1064.06	6 mm
15-1064.07	7 mm
15-1064.08	8 mm

PARTSCH

13,5 cm, 5 1/4"



Flachmeißel
 Chisels
 Ciseaux-burins
 Cinceles

15-1072.02	2 mm
15-1072.03	3 mm
15-1072.04	4 mm
15-1072.05	5 mm
15-1072.06	6 mm
15-1072.07	7 mm
15-1072.08	8 mm

PARTSCH

17 cm, 6 3/4"



Hohlmeißel
 Gouges
 Gouges
 Gubias

15-1074.02	2 mm
15-1074.03	3 mm
15-1074.04	4 mm
15-1074.05	5 mm
15-1074.06	6 mm
15-1074.07	7 mm
15-1074.08	8 mm

PARTSCH

17 cm, 6 3/4"



Osteotome
 Osteotomes
 Ostéotomes
 Osteótomos

15-1130.10	10 mm
15-1130.15	15 mm
15-1130.20	20 mm
15-1130.25	25 mm

STILLE

20 cm, 8"



Flachmeißel
 Chisels
 Ciseaux-burins
 Cinceles

15-1132.10	10 mm
15-1132.15	15 mm
15-1132.20	20 mm
15-1132.25	25 mm

STILLE

20 cm, 8"



Hohlmeißel
 Gouges
 Gouges
 Gubias

15-1134.10	10 mm
15-1134.15	15 mm
15-1134.20	20 mm
15-1134.25	25 mm

STILLE

20 cm, 8"



Osteotome
 Osteotomes
 Ostéotomes
 Osteótomos

15-1150.04	4 mm
15-1150.06	6 mm
15-1150.08	8 mm
15-1150.10	10 mm
15-1150.12	12 mm

MINI-LEXER

18 cm, 7"



Hohlmeißel
 Gouges
 Gouges
 Gubias

15-1154.04	4 mm
15-1154.06	6 mm
15-1154.08	8 mm
15-1154.10	10 mm
15-1154.12	12 mm

MINI-LEXER

18 cm, 7"



Osteotome
 Osteotomes
 Ostéotomes
 Osteótomos

15-1156.03	3 mm
15-1156.05	5 mm
15-1156.06	6 mm
15-1156.08	8 mm
15-1156.09	9 mm

HOKE

17 cm, 6 3/4"



Osteotome
 Osteotomes
 Ostéotomes
 Osteótomos

15-1160.07	7 mm
15-1160.10	10 mm
15-1160.15	15 mm
15-1160.20	20 mm
15-1160.25	25 mm
15-1160.30	30 mm

LEXER
 22 cm, 8 3/4"



Hohlmeißel
 Gouges
 Gouges
 Gubias

15-1164.07	7 mm
15-1164.10	10 mm
15-1164.15	15 mm
15-1164.20	20 mm
15-1164.25	25 mm
15-1164.30	30 mm

LEXER
 22 cm, 8 3/4"



Osteotome
 Osteotomes
 Ostéotomes
 Osteótomos

15-1200.03	3 mm
15-1200.04	4 mm
15-1200.06	6 mm
15-1200.08	8 mm
15-1200.10	10 mm
15-1200.12	12 mm
15-1200.15	15 mm

MINI-LAMBOTTE
 12,5 cm, 5"



Osteotome
 Osteotomes
 Ostéotomes
 Osteótomos

15-1210.06	6,5 mm
15-1210.15	15 mm
15-1210.20	20 mm
15-1210.25	25 mm
15-1210.30	30 mm
15-1210.38	38 mm
15-1210.44	44 mm

LAMBOTTE
 24 cm, 9 1/2"



Osteotome
 Osteotomes
 Ostéotomes
 Osteótomos

15-1211.06	6,5 mm
15-1211.15	15 mm
15-1211.20	20 mm
15-1211.25	25 mm
15-1211.30	30 mm
15-1211.38	38 mm
15-1211.44	44 mm

LAMBOTTE
 24 cm, 9 1/2"



Osteotome
 Osteotomes
 Ostéotomes
 Osteótomos

15-1230.06	6 mm
15-1230.09	9 mm
15-1230.10	10 mm
15-1230.13	13 mm
15-1230.16	16 mm
15-1230.19	19 mm
15-1230.25	25 mm
15-1230.32	32 mm

SMITH-PETERSEN

20 cm, 8"



Osteotome
 Osteotomes
 Ostéotomes
 Osteótomos

15-1231.06	6 mm
15-1231.09	9 mm
15-1231.10	10 mm
15-1231.13	13 mm
15-1231.16	16 mm
15-1231.19	19 mm
15-1231.25	25 mm
15-1231.32	32 mm

SMITH-PETERSEN

20 cm, 8"



Hohlmeißel
 Gouges
 Gouges
 Gubias

15-1234.06	6 mm
15-1234.09	9 mm
15-1234.10	10 mm
15-1234.13	13 mm
15-1234.16	16 mm
15-1234.19	19 mm
15-1234.25	25 mm
15-1234.32	32 mm

SMITH-PETERSEN

20 cm, 8"



Osteotome
 Osteotomes
 Ostéotomes
 Osteótomos

15-1250.06	6 mm
15-1250.13	13 mm
15-1250.19	19 mm
15-1250.25	25 mm
15-1250.32	32 mm

HIBBS

24 cm, 9 1/2"



Osteotome
 Osteotomes
 Ostéotomes
 Osteótomos

15-1251.06	6 mm
15-1251.13	13 mm
15-1251.19	19 mm
15-1251.25	25 mm
15-1251.32	32 mm

HIBBS

24 cm, 9 1/2"



Hohlmeißel
 Gouges
 Gouges
 Gubias

15-1254.06	6 mm
15-1254.13	13 mm
15-1254.19	19 mm
15-1254.25	25 mm
15-1254.32	32 mm

HIBBS
 24 cm, 9 1/2"



Hohlmeißel
 Gouges
 Gouges
 Gubias

15-1255.06	6 mm
15-1255.13	13 mm
15-1255.19	19 mm
15-1255.25	25 mm
15-1255.32	32 mm

HIBBS
 24 cm, 9 1/2"



Flachmeißel
 Chisels
 Ciseaux-burins
 Cinceles

15-1252.06	6 mm
15-1252.13	13 mm
15-1252.19	19 mm
15-1252.25	25 mm
15-1252.32	32 mm

HIBBS
 24 cm, 9 1/2"



Sternummeißel
 Sternum Chisel
 Sternotome
 Cíncel para esternón

LEBSCHKE
15-1654.24
 24,5 cm, 9 3/4"



15-1613.22

22 cm, 8 3/4"

Schädelspalter
Skull Breaker
Burin pour le crane
Escoplo para cráneo



VIRCHOW

15-1620.16



BRUNETTI

15-1628.01

28,5 cm, 11 1/4"



BRUNETTI

15-1628.02

28,5 cm, 11 1/4"

Autopsie-Besteck
Post Mortem Set
Set à autopsie
Juego de autopsia



15-1630.00



GERZOG
15-0219.25
 19,5 cm, 7 3/4"

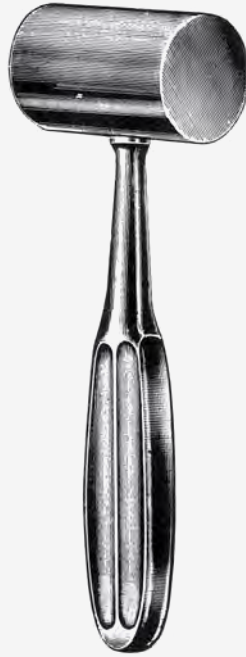

KIRK
15-0221.68
 21 cm, 8 1/4"



15-0100.45	450 g
15-0100.90	900 g



COLLIN
15-0120.20
 20 cm, 8"



WILLIGER
15-0144.34
 24 cm, 9 1/2"



LUCAE
15-0145.26
 19 cm, 7 1/2"



MEAD
15-0228.32
17 cm, 6 3/4"



15-0230.25 250 g
15-0230.40 400 g
26 cm, 10 1/4"



QUISLING
15-0231.75



15-0093.23
23,5 cm, 9 1/4"



FARABEUF

15-3010.15

15 cm, 6"



FARABEUF

15-3011.15

15 cm, 6"



WILLIGER

15-3116.65

16 cm, 6 1/4"



ALEXANDER

15-3533.16

16 cm, 6 1/4"

15-3533.20

20 cm, 8"



15-3031.10

10 mm

15-3031.15

15 mm

15-3031.20

20 mm

15-3031.25

25 mm

LAMBOTTE

21 cm, 8 1/4"

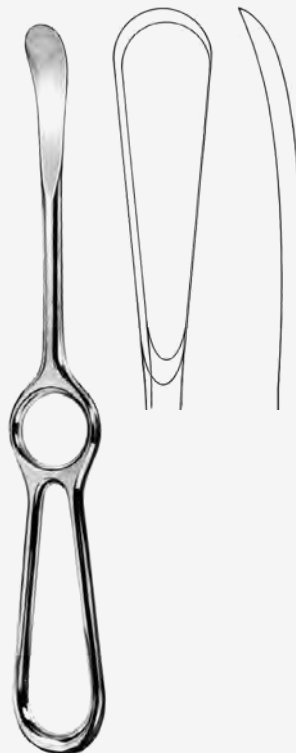

SEDILLOT

15-3171.15

21 cm, 8 1/4"



LANGENBECK

15-3021.18

18 cm, 7"

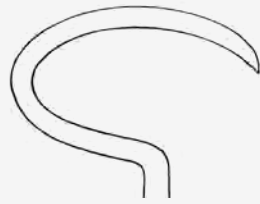

15-3510.17

17 cm, 6 3/4"



15-3520.17

17 cm, 6 3/4"

DOYEN

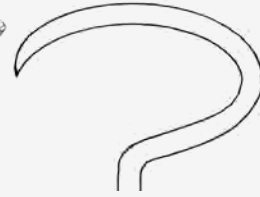

15-3511.17

17 cm, 6 3/4"



15-3521.17

17 cm, 6 3/4"

DOYEN



15-3564.01

17,5 cm, 6 3/4"



15-3564.03

17,5 cm, 6 3/4"



15-3564.02

21 cm, 8 1/4"



15-3564.04

21 cm, 8 1/4"



15-3564.05

20,5 cm, 8"



15-3564.06

20,5 cm, 8"



15-3564.07

22,5 cm, 8 3/4"

SEMB

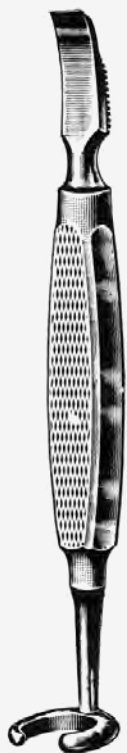

MATSON-ALEXANDER
 15-3504.22
 22 cm, 8 3/4"



MATSON
 15-3505.22
 22 cm, 8 3/4"



LANGENBECK
 15-4070.20
 20 cm, 8"



LANGENBECK
 15-4071.20
 20 cm, 8"

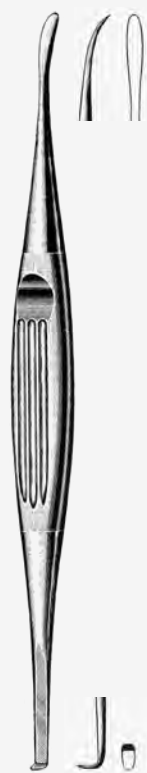

OVERHOLT
 15-3529.29
 29,5 cm, 11 1/2"



OVERHOLT
 15-3540.29
 29,5 cm, 11 1/2"



OVERHOLT
 15-3541.28
 28,5 cm, 11"



ADSON



15-3057.01

17 cm, 6 3/4"



15-3057.02

17 cm, 6 3/4"



15-3057.03

17 cm, 6 3/4"



15-3057.04

17 cm, 6 3/4"



KEY

19 cm, 7 1/2"

15-4169.06 6 mm

15-4169.12 12 mm

15-4169.19 19 mm

15-4169.25 25 mm

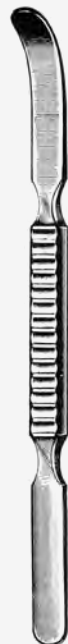

WATSON-CHEYNE

15-4181.17

17,5 cm, 6 3/4"



MC DONALD

15-4183.19

19 cm, 7 1/2"



MURPHY-LANE
15-4185.30
 30 cm, 11 3/4"



15-1649.45
 24,5 cm, 9 3/4"



BENNETT

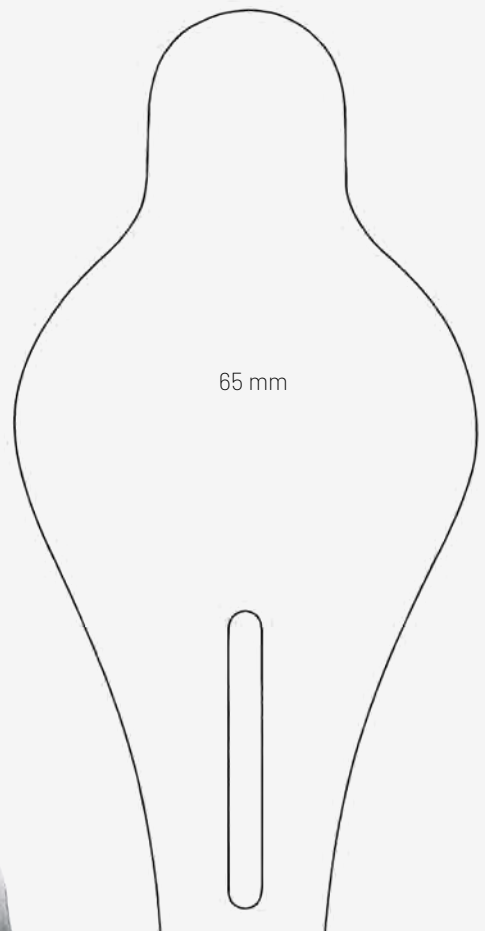

15-1649.65
 24,5 cm, 9 3/4"



15

Knochenhebel
Bone Levers
Leviers à os
Elevadores para huesos



HOHMANN

15-1661.43

24,5 cm, 9 3/4"

HOHMANN

15-1662.22

26 cm, 10 1/4"

HOHMANN

15-1662.33

28 cm, 11"

HOHMANN

15-1664.24

26,5 cm, 10 1/2"

22 mm



HOHMANN

15-1665.22

26 cm, 10 1/4"



BLOUNT

15-1630.26

26 cm, 10 1/4"

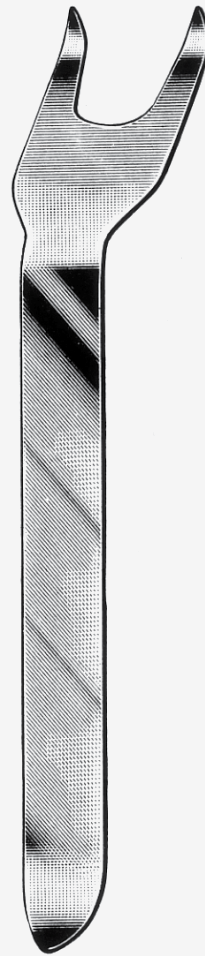

BLOUNT

15-1631.26

26 cm, 10 1/4"

15

Knochenheber
Bone Levers
Leviers à os
Elevadores para huesos



15-1625.60

14 cm, 5 1/2"



MINI-HOHMANN

6 mm



15-1636.60

16 cm, 6 1/4"

8 mm



15-1636.80

16 cm, 6 1/4"



TAYLOR

15-1635.16

75 x 30 mm

15-1637.16

100 x 30 mm

16,5 cm, 6 1/2"

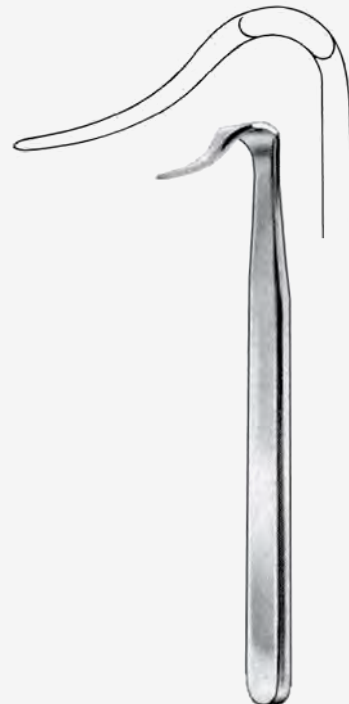

BLOUNT

15-1633.17

17,5 cm, 7"



SMILLIE

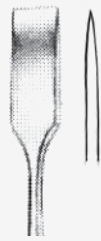

15-1638.01

17 cm, 6 3/4"



15-1638.02

17 cm, 6 3/4"



15-1638.03

17 cm, 6 3/4"



BIRCHER-GANSKE

15-1639.19

19 cm, 7 1/2"



BIRCHER-GANSKE

15-1640.19

19 cm, 7 1/2"

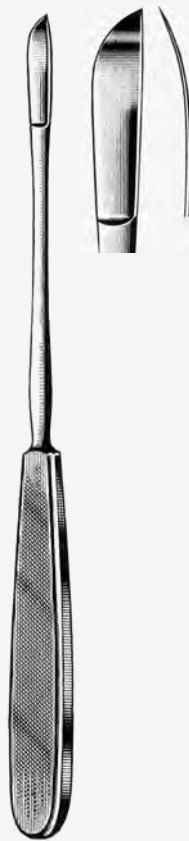

NEFF

15-1641.22

22 cm, 8 1/2"

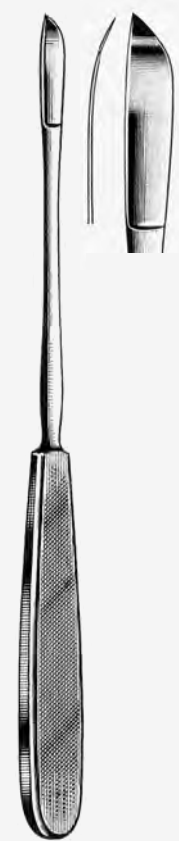

NEFF

15-1642.22

22 cm, 8 1/2"

15

Sehnenstripper, Knochenfeilen

Tendon Strippers, Bone Files

Instruments à écorcher les tendons, limes à os
Separadores para tendones, limas para huesos



15-1644.01

Fig. 1



15-1644.02

Fig. 2



15-1644.03

Fig. 3



15-1644.04

Fig. 4



15-1644.05

Fig. 5

BUNNEL

15 cm, 5 3/4"



15-1650.22

22 cm, 8 1/2"

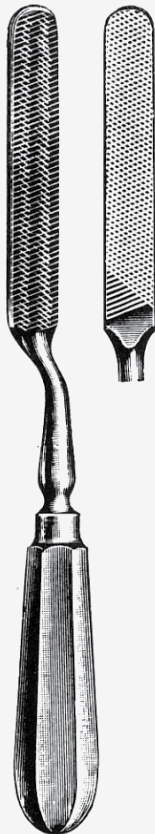

15-1651.24

24,5 cm, 9 3/4"

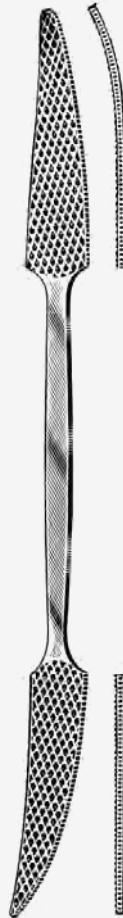

PUTTI

15-1655.27

27 cm, 10 1/2"



15-1657.30

30 cm, 11 3/4"

Chapter 16

Table of Contents

Amputation, Handbohrer, Osteosynthese / **p. 248 - 267**

Amputation, Bone Drills, Osteosynthesis / **p. 248 - 267**

Amputation, perforateurs à main, ostéosynthèse / **p. 248 - 267**

Amputación, perforadores a mano, osteosíntesis / **p. 248 - 267**



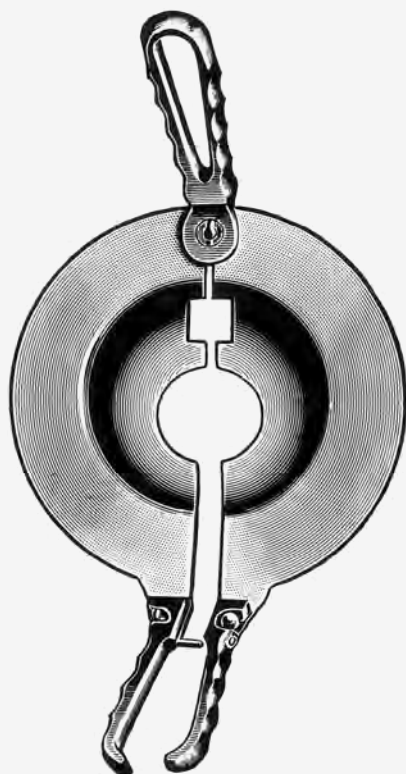

**16-0206.00**Komprimeter
Compression Apparatus
Appareil compressif
Aparato de compresión**PERCY****16-1100.00**Amputationsretraktor
Amputation Retractor
Rétracteur pour amputation
Retractor para amputación

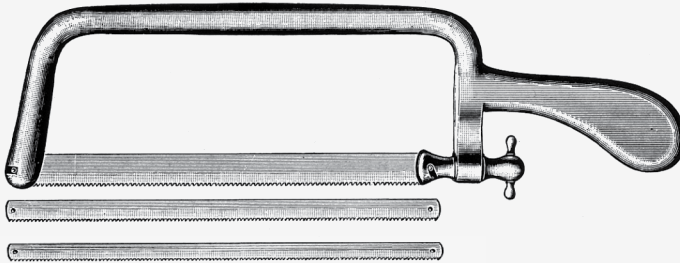

CHARRIERE

16-1250.00

komplett mit 2 Sägeblättern
complete with 2 saw blades
complète avec 2 lames de scie
completo con 2 hojas de sierra



16-1250.03

3 mm



16-1250.05

5 mm



16-1250.07

7 mm

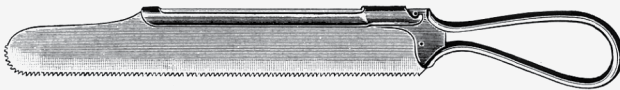

CHARRIERE

16-1230.30

30 cm, 12"

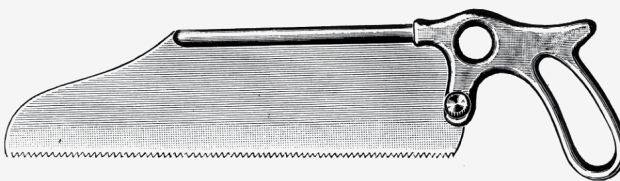

SATTERLEE

16-1235.31

31 cm, 12 1/2"



LANGENBECK

16-1677.23

23 cm, 9"



16-1678.00

komplett mit 3 Bohrern
 complete with 3 drill points
 complète avec 3 vrilles
 completo con 3 brocas

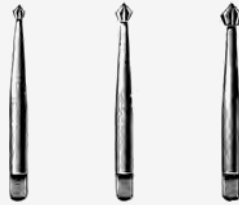

16-1678.01

3 Bohrer, Set
 3 drill points, set
 3 vrilles, jeu
 3 brocas, juego



RADOLF

16-1679.13

13,5 cm, 5 1/4"



16-1680.01

Fingerringsäge
 Finger ring saw
 Scie pour bagues
 Sierra para abrir anillos

16-1680.00

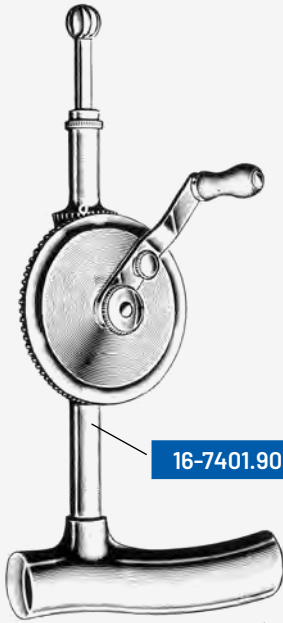

16-7401.90

STILLE

16-7401.00

komplett
 complete
 complète
 completo



16-7401.25

2,5 mm



16-7401.30

3,0 mm



16-7401.35

3,5 mm



16-7401.40

4,0 mm



16-7401.05

5,0 mm



16-7401.08

8,0 mm



16-7401.10

10,0 mm



16-7401.12

12,0 mm



16-7401.16

16,0 mm



16-7402.10

1,0 mm



16-7402.15

1,5 mm



16-7402.20

2,0 mm



16-7420.90

STILLE-SHERMANN

16-7420.00

24 cm, 9 1/2"

komplett
 complete
 complète
 completo



16-7420.25

2,5 mm



16-7420.30

3,0 mm



16-7420.35

3,5 mm



16-7410.90

MOORE

16-7410.00

24 cm, 9 1/2"

komplett
complete
completè
completo

9,0 mm



7,5 mm



7,0 mm



16-7410.30

3 Bohrer, Set,
3 drill points, set
3 vrilles, jeu
3 brocas, juego



CUSHING

16-7431.14

14,0 mm



MC KENZIE

16-7433.00

13,0 mm



HUDSON

16-7430.00

27 cm, 10 3/4"

komplett
complete
completè
completo



16-7430.09

9,0 mm



16-7430.14

14,0 mm



16-7430.16

16,0 mm



16-7430.22

22,0 mm



16-7432.00



KIRSCHNER

16-7440.00



16-7441.00

komplett
complete
complète
completo



KIRSCHNER

16-7450.00



16-7451.00

komplett
complete
complète
completo



16-7500.92

Spannschlüssel
 Key
 Clef
 Llave

BUNNELL

16-7500.16



RALK

16-7510.20

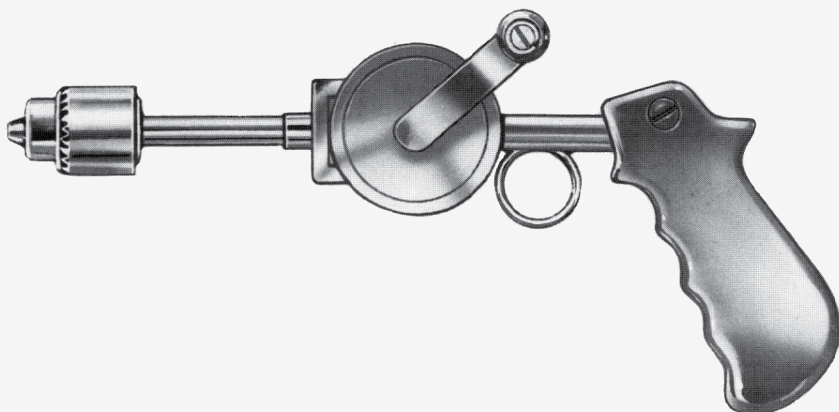

16-7520.00



16-7521.00

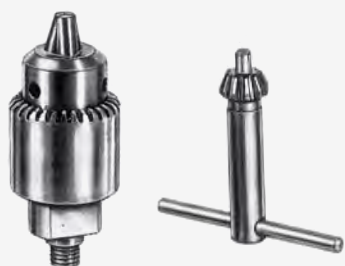

16-7533.00

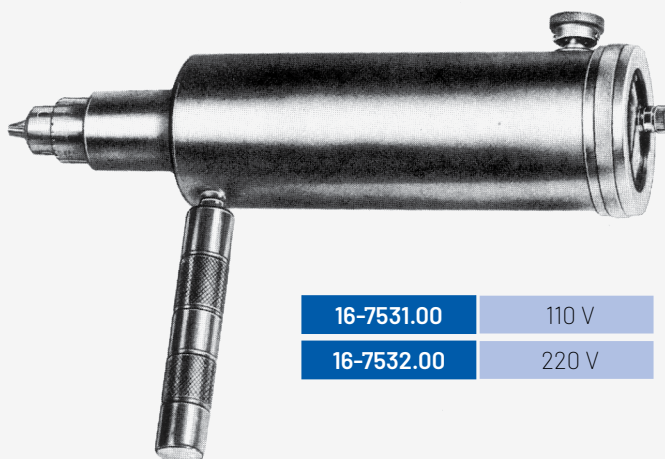

16-7531.00

110 V

16-7532.00

220 V



16-7550.20	2,0 mm
16-7550.25	2,5 mm
16-7550.30	3,0 mm
16-7550.32	3,2 mm
16-7550.35	3,5 mm
16-7550.40	4,0 mm
16-7550.50	5,0 mm
16-7550.60	6,0 mm
16-7550.70	7,0 mm



16-7552.10	1,0 mm
16-7552.12	1,2 mm
16-7552.15	1,5 mm
16-7552.18	1,8 mm
16-7552.20	2,0 mm
16-7552.22	2,2 mm
16-7552.25	2,5 mm
16-7552.28	2,8 mm
16-7552.30	3,0 mm
16-7552.32	3,2 mm
16-7552.35	7,0 mm
16-7552.40	4,0 mm
16-7552.50	5,0 mm



16-7554.10	1,0 mm
16-7554.15	1,5 mm
16-7554.20	2,0 mm
16-7554.25	2,5 mm
16-7554.28	2,8 mm
16-7554.30	3,0 mm
16-7554.32	3,2 mm
16-7554.35	3,5 mm
16-7554.40	4,0 mm
16-7554.50	5,0 mm
16-7554.60	6,0 mm



16-7562.04	4,0 mm
16-7562.06	6,0 mm
16-7562.08	8,0 mm
16-7562.10	10,0 mm
16-7562.12	12,0 mm
16-7562.14	14,0 mm
16-7562.16	16,0 mm



16-7564.04	4,0 mm
16-7564.06	6,0 mm
16-7564.08	8,0 mm
16-7564.10	10,0 mm
16-7564.12	12,0 mm
16-7564.14	14,0 mm
16-7564.16	16,0 mm



16-7572.08	8,0 mm
16-7572.10	10,0 mm
16-7572.12	12,0 mm

DOYEN

DOYEN

ALBEE



DOYEN

16-7566.12

12,0 mm



16-7568.08 8,0 mm

16-7568.10 10,0 mm



DOYEN

16-7570.12 12,0 mm

16-7570.15 15,0 mm



ALBEE
 16-7574.07
 7,0 mm



BORCHARDT
 16-7576.13
 13,0 mm



16-7577.25
 25,0 mm



TOTI
 16-7578.08
 8,0 mm



16-7592.14
 14 cm, 5 1/2"



PERTHES
 16-7595.21
 21 cm, 8 1/4"



16-7580.20	20 mm
16-7580.25	25 mm
16-7580.30	30 mm
16-7580.35	35 mm
16-7580.40	40 mm
16-7580.45	45 mm
16-7580.50	50 mm



16-7582.20	20 mm
16-7582.25	25 mm
16-7582.30	30 mm
16-7582.35	35 mm
16-7582.40	40 mm
16-7582.45	45 mm
16-7582.50	50 mm

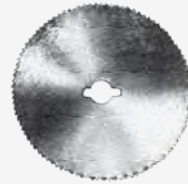

16-7584.20	20 mm
16-7584.25	25 mm
16-7584.30	30 mm
16-7584.35	35 mm
16-7584.40	40 mm
16-7584.45	45 mm
16-7584.50	50 mm

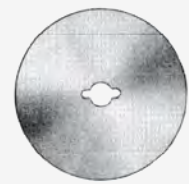

16-7586.17	17 mm
16-7586.22	22 mm
16-7586.27	27 mm
16-7586.32	32 mm
16-7586.37	37 mm
16-7586.42	42 mm
16-7586.47	47 mm



16-7587.00



16-7588.00



16-7590.00



	60 mm	120 mm	140 mm	160 mm	310 mm
Ø 1,0 mm	16-7606.10	16-7612.10	16-7614.10	16-7616.10	16-7631.10
Ø 1,2 mm	16-7606.12	16-7612.12	16-7614.12	16-7616.12	16-7631.12
Ø 1,4 mm	16-7606.14	16-7612.14	16-7614.14	16-7616.14	16-7631.14
Ø 1,5 mm	16-7606.15	16-7612.15	16-7614.15	16-7616.15	16-7631.15
Ø 1,6 mm	16-7606.16	16-7612.16	16-7614.16	16-7616.16	16-7631.16
Ø 1,8 mm	16-7606.18	16-7612.18	16-7614.18	16-7616.18	16-7631.18
Ø 2,0 mm	16-7606.20	16-7612.20	16-7614.20	16-7616.20	16-7631.20
Ø 2,2 mm	16-7606.22	16-7612.22	16-7614.22	16-7616.22	16-7631.22
Ø 2,5 mm				16-7616.25	16-7631.25

KIRSCHNER



310 mm	
16-7632.10	Ø 1,0 mm
16-7632.12	Ø 1,2 mm
16-7632.15	Ø 1,5 mm
16-7632.16	Ø 1,6 mm
16-7632.18	Ø 1,8 mm
16-7632.20	Ø 2,0 mm
16-7632.22	Ø 2,2 mm
16-7632.25	Ø 2,5 mm

KIRSCHNER



16-7690.13	13 cm, 5"
16-7690.14	14 cm, 5 1/2"
16-7690.15	15 cm, 5 3/4"
16-7690.16	16 cm, 6 1/4"
16-7690.18	18 cm, 7"
16-7690.20	20 cm, 8"
16-7690.21	21 cm, 8 1/4"

STEINMANN

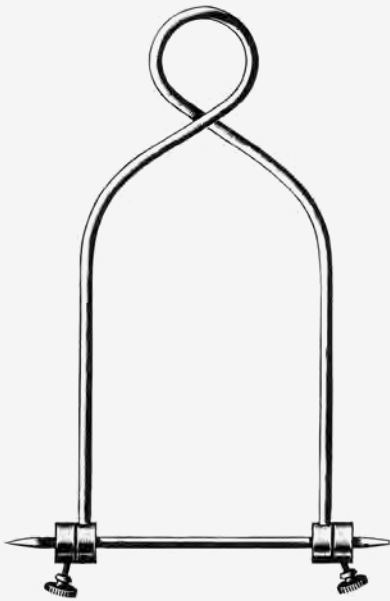

BOEHLER

16-7702.16 160 x 90 mm

16-7702.21 160 x 110 mm

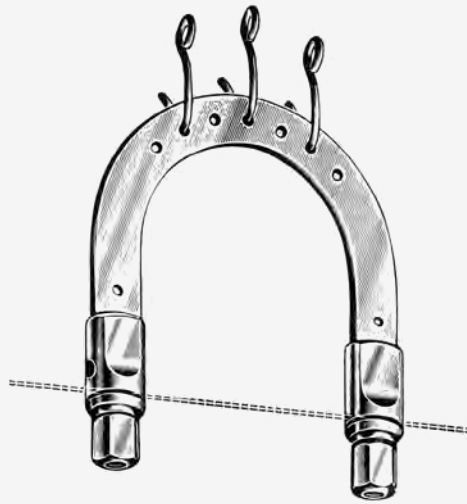

KIRSCHNER

16-7712.09 95 x 70 mm

16-7712.10 105 x 105 mm

16-7712.12 120 x 120 mm

16-7712.15 155 x 155 mm

16-7712.20 200 x 155 mm

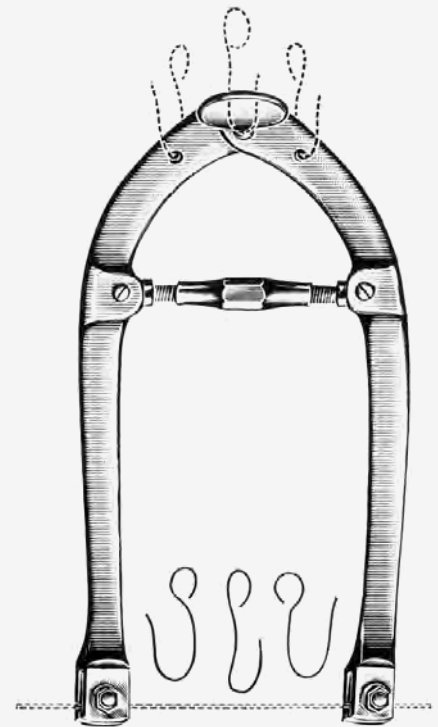

16-7714.18 180 x 100 mm

16-7714.27 270 x 160 mm

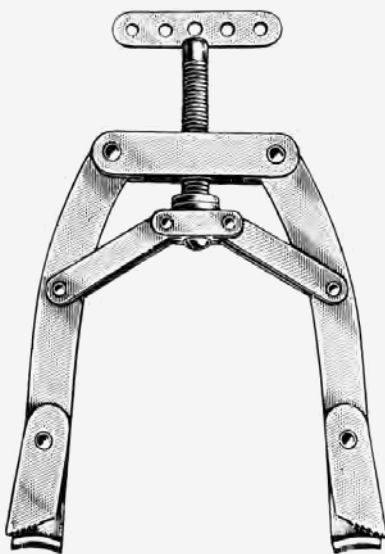

KIRSCHNER

16-7718.01 klein / small

16-7718.02 groß / big



16-7715.01

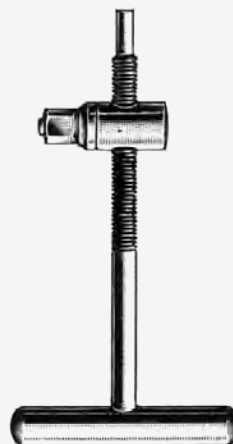

16-7716.02



16-7719.01



16-7719.02

16

Knocheninstrumente, -draht
Bone Wire and Instruments
 Fil à os et instruments
 Hilo para huesos e instrumentos



16-7530.02	0,2 mm
16-7530.03	0,3 mm
16-7530.04	0,4 mm
16-7530.05	0,5 mm
16-7530.06	0,6 mm
16-7530.07	0,7 mm
16-7530.08	0,8 mm
16-7530.09	0,9 mm
16-7530.10	1,0 mm
16-7530.11	1,1 mm
16-7530.12	1,2 mm
16-7530.15	1,5 mm

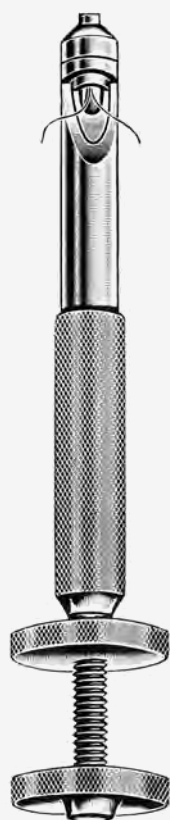

LOUTE
16-7531.21
 21 cm, 8 1/4"



16-7533.18
 18 cm, 7"

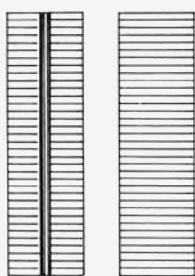

16-7532.17
 17 cm, 6 3/4"

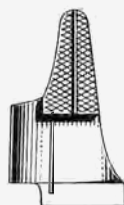

16-7534.15
 15 cm, 5 3/4"

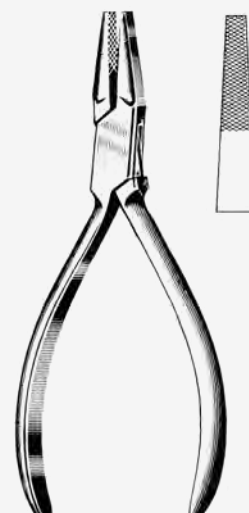

16-7536.14
 14 cm, 5 1/2"



16-7540.16

16 cm, 6 1/4"



16-7542.15

15 cm, 5 3/4"



16-7545.22

22 cm, 8 1/2"

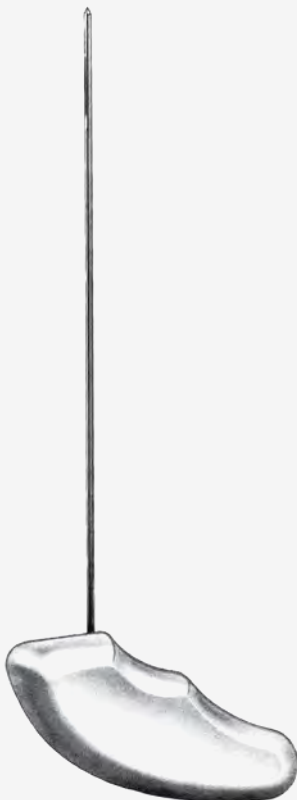

16-7560.24 2,4 mm

16-7560.32 3,2 mm

16-7560.48 4,8 mm

16-7560.64 6,4 mm



16-7562.24 2,4 mm

16-7562.32 3,2 mm

16-7562.48 4,8 mm

16-7562.64 6,4 mm

16

Knochennagelung
Bone Nailing
 Enclouage des os
 Enclavamiento de huesos

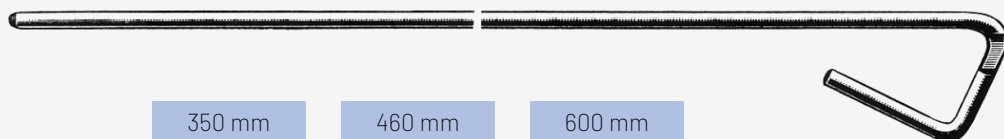

	350 mm	460 mm	600 mm
Ø 2,5 mm	16-7981.25	16-7982.25	
Ø 3,0 mm	16-7981.30	16-7982.30	
Ø 3,5 mm	16-7981.35	16-7982.35	16-7983.35
Ø 4,0 mm	16-7981.40	16-7982.40	16-7983.40
Ø 5,0 mm	16-7981.50	16-7982.50	
Ø 6,0 mm			16-7983.60



KUENTSCHER
 16-7971.26
 26 cm, 10 1/4"



KUENTSCHER
 16-7973.35
 35 cm, 13 1/2"



KUENTSCHER
 16-7986.21
 21 cm, 8 1/4"



KUENTSCHER
 16-7988.21
 21 cm, 8 1/4"



KUENTSCHER
16-7990.00
 63 cm, 25"



16-7990.01
 Fig.1



16-7990.02
 Fig.2



16-7990.03
 Fig.3



16-7990.04
 Fig.4

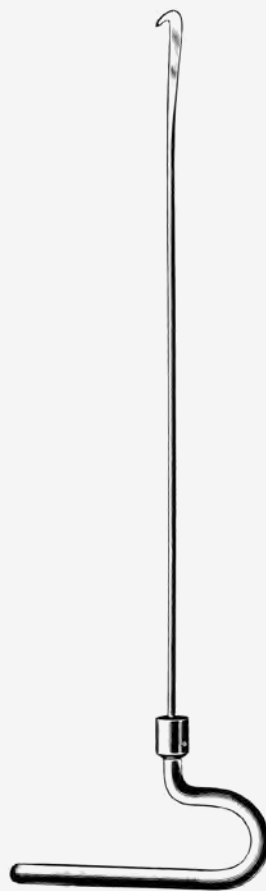

16-7996.29	29 cm, 11 1/4"
16-7996.37	37 cm, 14 1/2"
16-7996.42	42 cm, 15"
16-7996.49	49 cm, 19 1/2"



16-7998.30
 30 cm, 12"

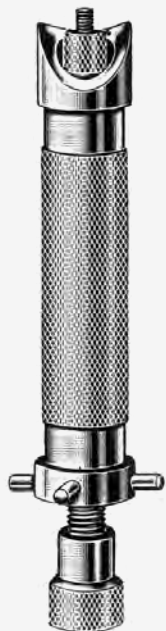

LLOYD

16-7602.20

20 cm, 8"



LANE

16-7620.25

25 cm, 10"



LANE

16-7622.25

25 cm, 10"



WILLIAMS

16-7624.24

24 cm, 9 1/2"



16-7628.25

2,5 mm

16-7628.35

3,5 mm



LANE

16-7635.18

18 cm, 7"



LANE

16-7635.23

23 cm, 9"



LANE

16-7639.22

22 cm, 8 1/2"



16-7680.45	4,5 mm
16-7680.70	7,0 mm



16-7681.05	5,0 mm
-------------------	--------

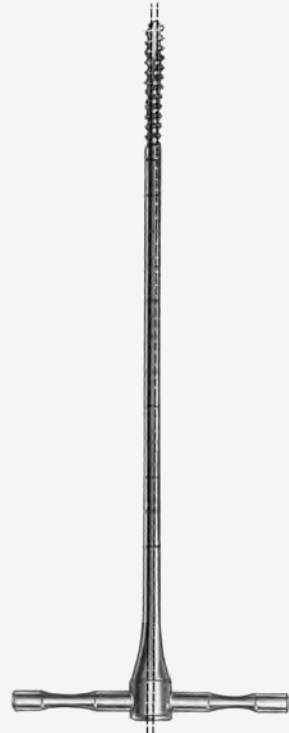

16-7682.45	4,5 mm
16-7682.70	7,0 mm



16-7683.25	2,5 mm
16-7683.35	3,5 mm
16-7683.50	5,0 mm



16-7684.00

Chapter 18

Table of Contents

Neurochirurgie, Laminektomie, Gefäßchirurgie / **p. 268 - 283**

Neurosurgery, Laminectomy, Vascular Surgery / **p. 268 - 283**

Neurochirurgie, laminectomie, chirurgie vasculaire / **p. 268 - 283**

Neurocirugía, laminectomía, cirugía vascular / **p. 268 - 283**





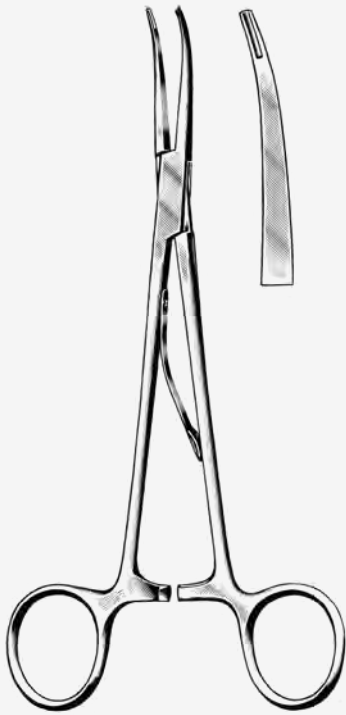

MC KENZIE

18-1011.15 15 cm, 5 3/4"

18-1011.19 19 cm, 7 1/2"

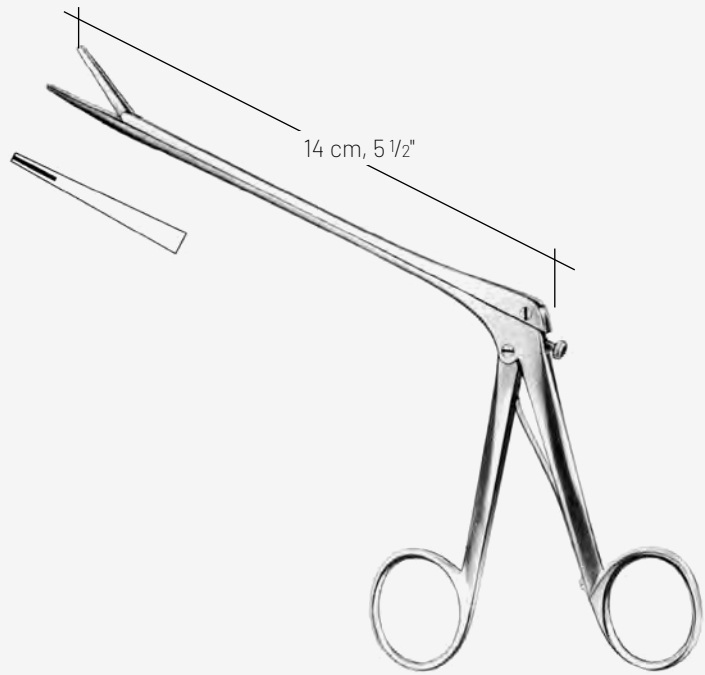

OLIVECRONA-TOENNIS

18-1019.14

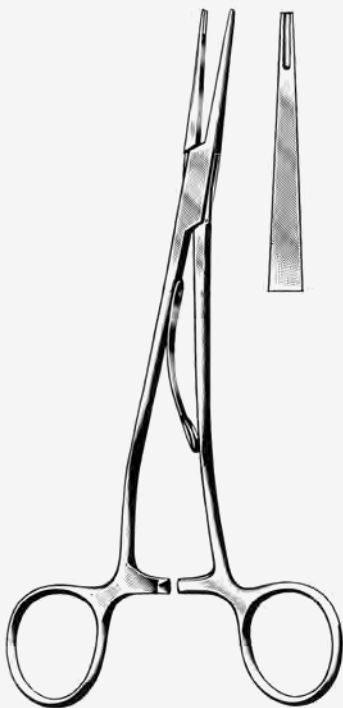

MC KENZIE

18-1013.15 15 cm, 5 3/4"

18-1013.19 19 cm, 7 1/2"



SMITHWICK

18-1015.23 23 cm, 9"

18-1015.26 26 cm, 10 1/4"

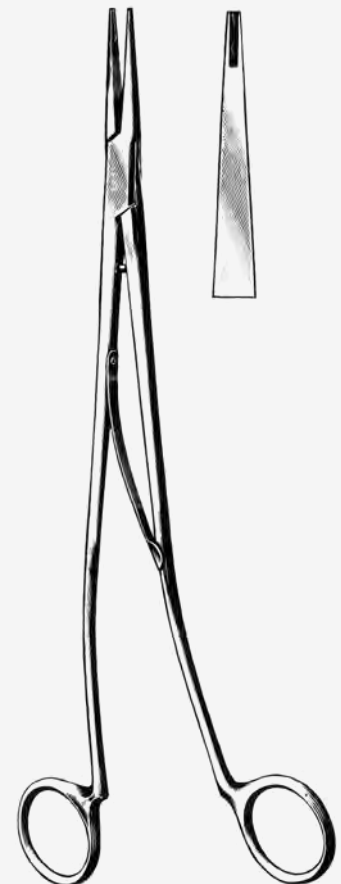

SWEET

18-1017.23 23 cm, 9"

18-1017.26 26 cm, 10 1/4"



18-1020.00
 148 x 40 x 6 mm

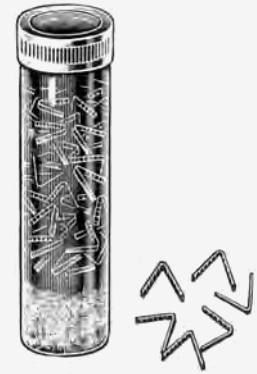

18-1021.00
 100 Stück / Pieces / Pièces / Piezas



Kopfhautklammer, -anlegezange
 Scalp Hemostasis Clip, Applying Forceps
 Pince hémostatique pour le cuir chevelu, pince à poser
 Pinza hemostática para cuero cabelludo, pinza para poner

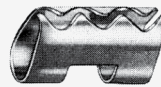

RANEY
18-1028.00

RANEY
18-1027.00



CRUTCHFIELD
18-1026.35



CRUTCHFIELD
18-1026.50

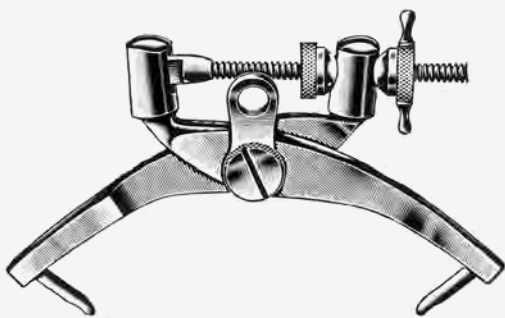

CRUTCHFIELD
18-1025.01



CRUTCHFIELD
18-1025.02

18

Nervhaken
Nerve Retractors
 Ecarteurs á nerfs
 Separadores para nervios



DANDY
18-1051.20
20 cm, 8"



DANDY
18-1052.20
20 cm, 8"



DANDY
18-1053.20
20 cm, 8"



GRAHAM
18-1061.16
16,5 cm, 6 1/2"



CUSHING	Ø 4 mm
18-1056.19	19 cm, 7 1/2 "
18-1056.28	28 cm, 11"



CUSHING	Ø 6 mm
18-1058.19	19 cm, 7 1/2 "
18-1058.28	28 cm, 11"



ADSON
18-1068.20
20 cm, 8"



ADSON
18-1069.20
20 cm, 8"



LOVE

18-1080.19

19 cm, 7 1/2"

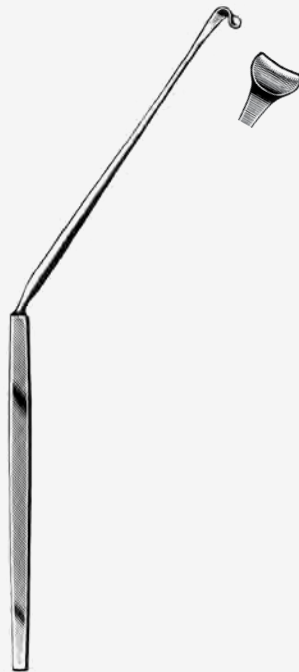

LOVE

18-1081.19

19 cm, 7 1/2"

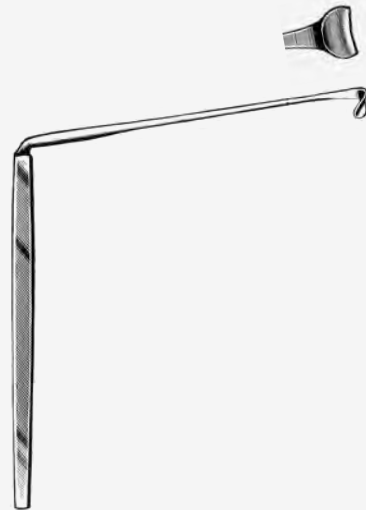

LOVE

18-1083.19

19 cm, 7 1/2"



SACHS

18-1064.18

18,5 cm, 7 1/4"



SMITHWICK

18-1070.29

29 cm, 11 1/4"

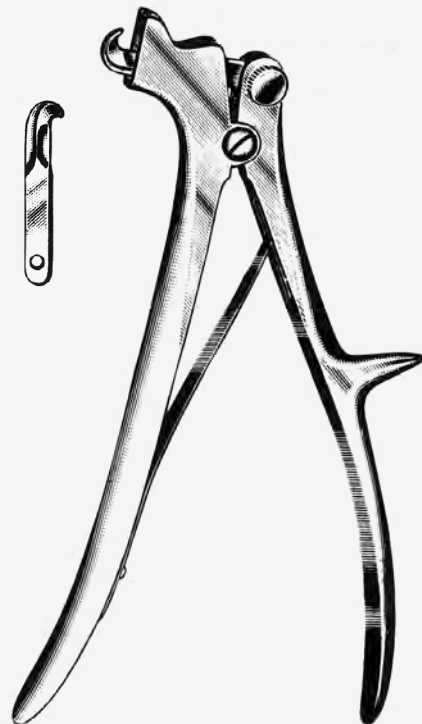

DE VILBISS

18-1096.21

21 cm, 8 1/4"



DE MARTEL

18-1090.33

33 cm, 13"

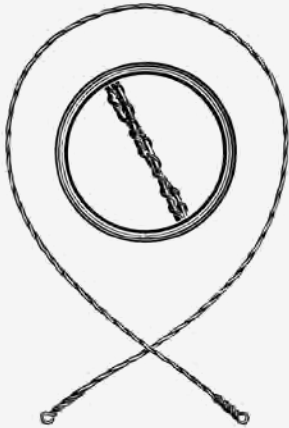

OLIVECRONA

18-1092.30 30 cm

18-1092.40 40 cm

18-1092.50 50 cm

18-1092.60 60 cm

18-1092.70 70 cm

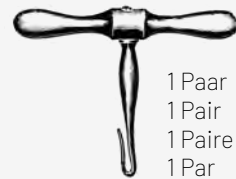

1 Paar
 1 Pair
 1 Paire
 1 Par

GIGLI

18-1094.00



TOENNIS

18-1141.25

25 cm, 10"



SACHS

18-1143.21

21 cm, 8 1/4"



SACHS

18-1145.21

21 cm, 8 1/4"



MILLIGAN

18-1147.21

21 cm, 8 1/4"

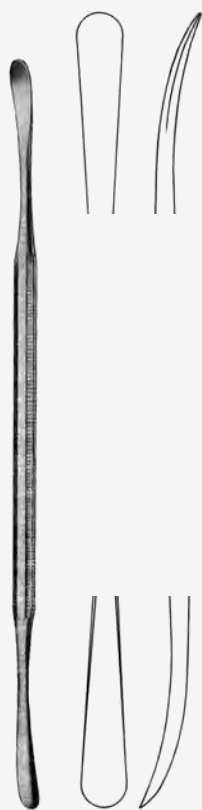

18-1149.22

22 cm, 8 1/2"

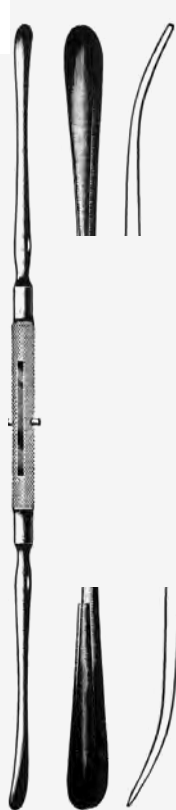

DAVIS

18-1151.24

24 cm, 9 1/2"

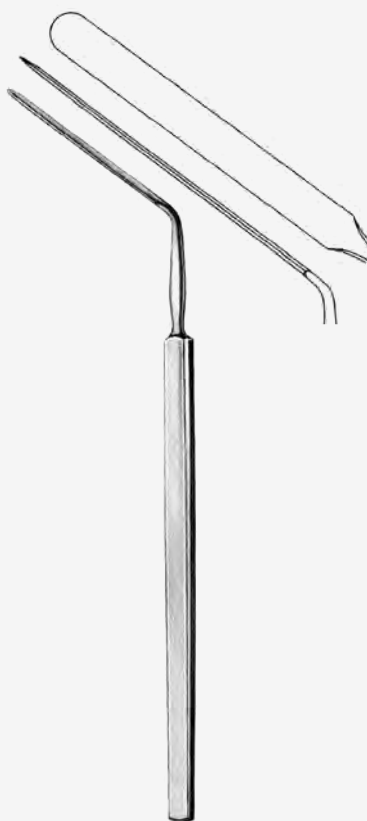

HORSLEY

18-1155.20

20 cm, 8"



PENFIELD

18-1161.01

17,5 cm, 7"



PENFIELD

18-1161.02

19,5 cm, 7 3/4"



PENFIELD

18-1161.03

19,5 cm, 7 3/4"



HALLE

18-1170.20

20 cm, 8"

18

Pinzetten, Spatel
Forceps, Spatulas
 Pinces, Spatules
 Pinzas, Espatulas



ADSON
18-1210.23
23 cm, 9"



ADSON
18-1211.23
23 cm, 9"



ADSON
18-1213.23
23 cm, 9"



CUSHING	
18-1250.07	7/9 mm
18-1250.11	11/13 mm
18-1250.15	15/18 mm
18-1250.18	18/22 mm

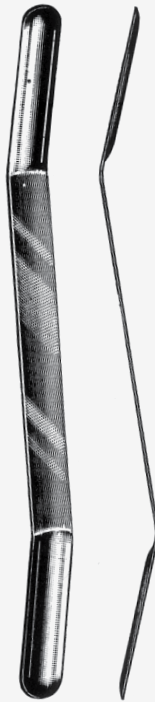

OLIVECRONA	
18-1253.07	7/9 mm
18-1253.11	11/13 mm
18-1253.15	15/18 mm
18-1253.18	18/22 mm



HEIFETZ	
18-1260.08	8 mm
18-1260.11	11 mm
18-1260.14	14 mm
18-1260.17	17 mm



Ø 4,0 mm

ADSON

18-1290.21

21 cm, 8 1/4"



FRAZIER

18-1298.12

12 cm, 4 3/4"



FRAZIER

30°	
18-1295.06	Charr. 6
18-1295.07	Charr. 7
18-1295.08	Charr. 8
18-1295.09	Charr. 9
18-1295.10	Charr. 10
18-1295.11	Charr. 11
18-1295.12	Charr. 12

75°	
18-1297.06	Charr. 6
18-1297.07	Charr. 7
18-1297.08	Charr. 8
18-1297.09	Charr. 9
18-1297.10	Charr. 10
18-1297.11	Charr. 11
18-1297.12	Charr. 12



CLOWARD

18-1301.16

16 cm, 6 1/4"



INGE

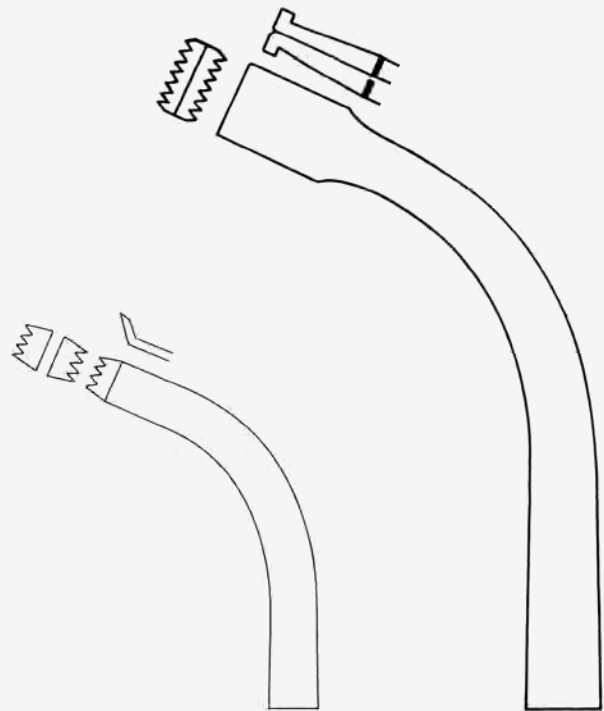

18-1305.17

17 cm, 6 3/4"

18-1305.27

27 cm, 10 1/2"

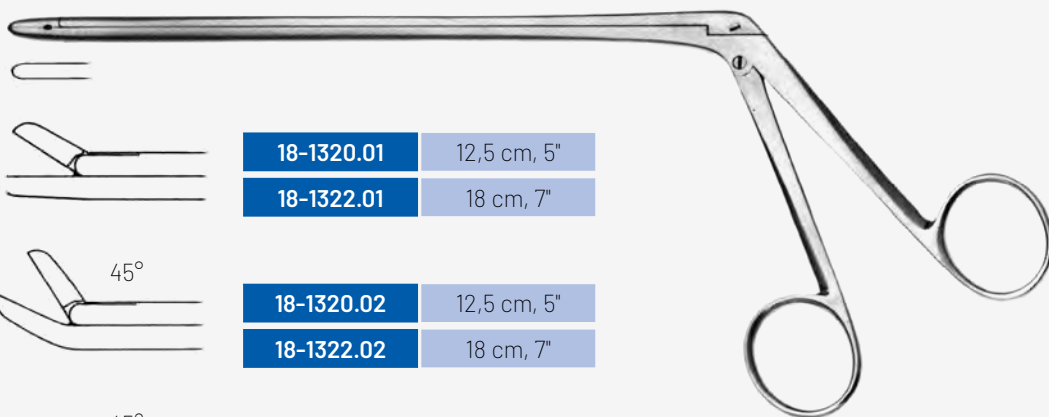

2,0 x 10 mm

	18-1320.01	12,5 cm, 5"
	18-1322.01	18 cm, 7"

2,0 x 10 mm

	18-1320.02	12,5 cm, 5"
	18-1322.02	18 cm, 7"

2,0 x 10 mm

	18-1320.03	12,5 cm, 5"
	18-1322.03	18 cm, 7"

CUSHING

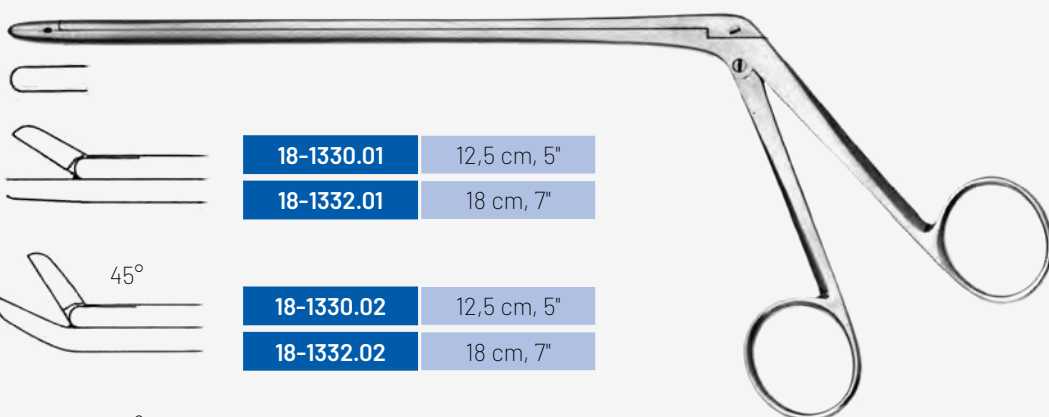

3,0 x 10 mm

	18-1330.01	12,5 cm, 5"
	18-1332.01	18 cm, 7"

3,0 x 10 mm

	18-1330.02	12,5 cm, 5"
	18-1332.02	18 cm, 7"

3,0 x 10 mm

	18-1330.03	12,5 cm, 5"
	18-1332.03	18 cm, 7"

LOVE-GRUENWALD

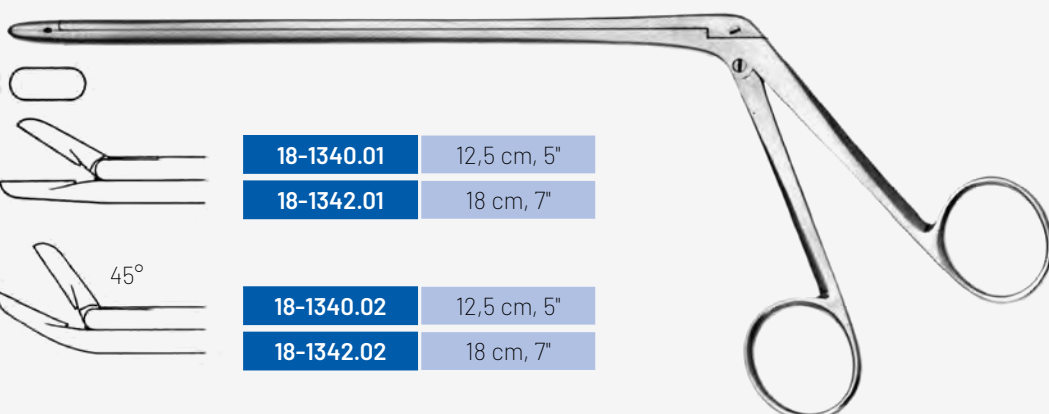

4,0 x 10 mm

	18-1340.01	12,5 cm, 5"
	18-1342.01	18 cm, 7"

4,0 x 10 mm

	18-1340.02	12,5 cm, 5"
	18-1342.02	18 cm, 7"

4,0 x 10 mm

	18-1340.03	12,5 cm, 5"
	18-1342.03	18 cm, 7"

SPURLING

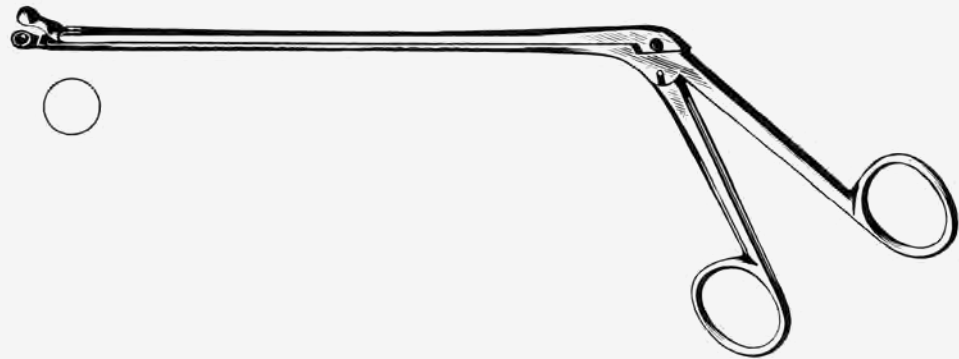

OLDBERG
18-1344.25
25 cm, 10"

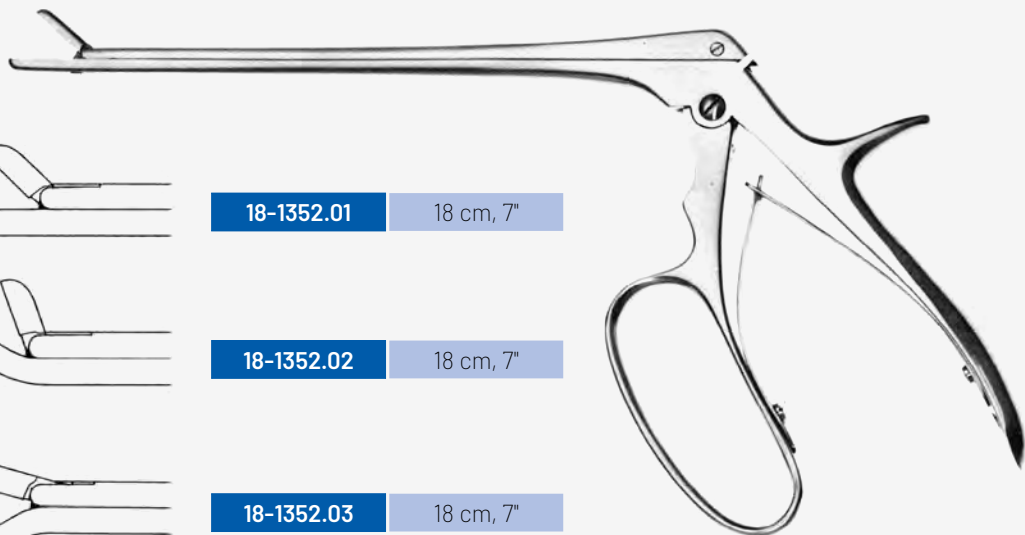

FERRIS-SMITH

3,0 x 10 mm

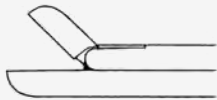

18-1352.01 18 cm, 7"

3,0 x 10 mm



18-1352.02 18 cm, 7"

3,0 x 10 mm

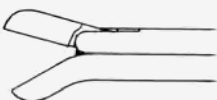

18-1352.03 18 cm, 7"



4,0 mm

WAGNER
18-1358.20
20 cm, 8"

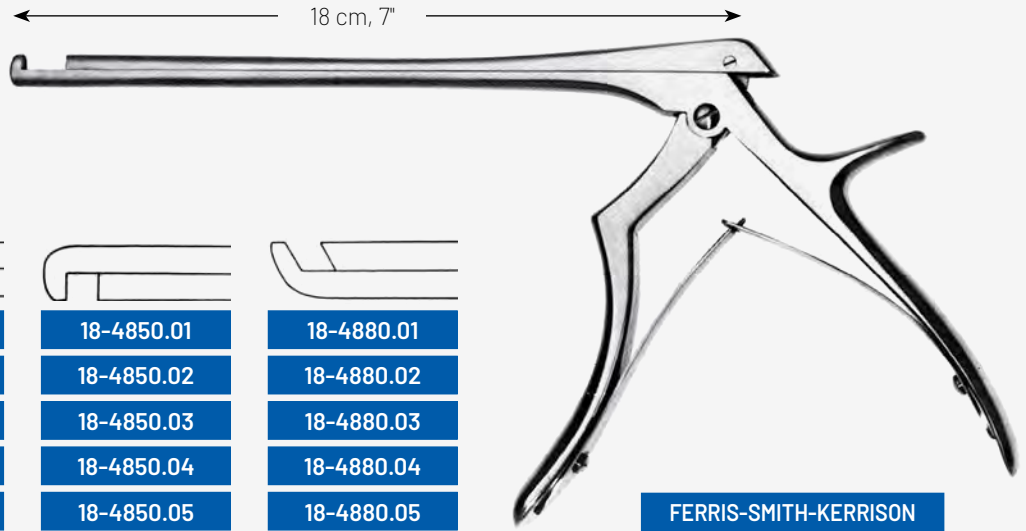

1 mm	18-4800.01	18-4850.01	18-4880.01
2 mm	18-4800.02	18-4850.02	18-4880.02
3 mm	18-4800.03	18-4850.03	18-4880.03
4 mm	18-4800.04	18-4850.04	18-4880.04
5 mm	18-4800.05	18-4850.05	18-4880.05

FERRIS-SMITH-KERRISON

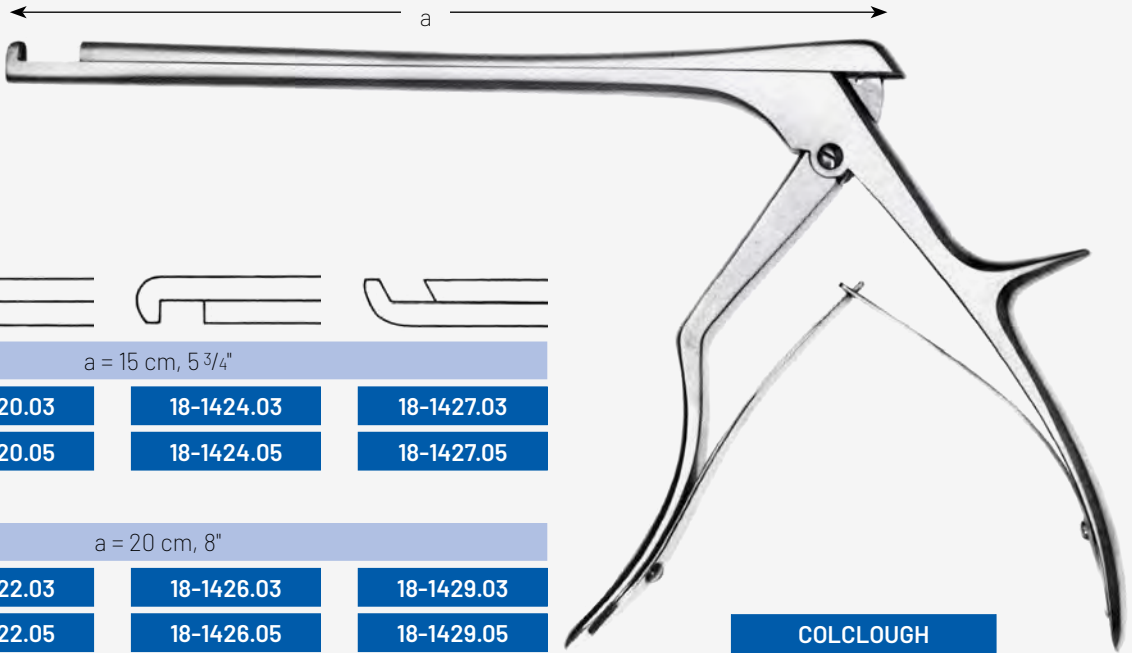

a = 15 cm, 5 3/4"

3 mm	18-1420.03	18-1424.03	18-1427.03
5 mm	18-1420.05	18-1424.05	18-1427.05

a = 20 cm, 8"

3 mm	18-1422.03	18-1426.03	18-1429.03
5 mm	18-1422.05	18-1426.05	18-1429.05

COLCLOUGH

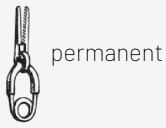

permanent

Kat. Nr.
 Cat. ref.
 No. de cat.
 Núm. de cat.

Maullänge
 Length of Jaws
 Longueur des mors
 Longitud de boca

Maulöffnung
 Opening of jaws
 Ouverture des mors
 Apertura de boca

Schließkraft
 Closing Force
 Force de fermeture
 Presión de oclusión

18-1470.30	18-1472.30	18-1480.35	18-1482.35	18-1484.33	18-1490.30	18-1492.35
3,0 mm	3,0 mm	5,0 mm	5,0 mm	5,0 mm	3,0 mm	5,0 mm
3,0 mm	3,0 mm	3,5 mm	3,5 mm	3,3 mm	3,0 mm	3,5 mm
100-130 g	100-130 g	100-130 g	100-130 g	100-130 g	100-130 g	100-130 g

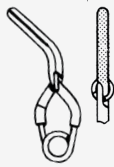

18-1494.35	18-1496.33	18-1498.30	18-1510.40	18-1512.38	18-1514.35	18-1518.50	18-1566.40
5,0 mm	5,0 mm	5,0 mm	7,0 mm	7,0 mm	7,0 mm	7,0 mm	7,0 mm
3,5 mm	3,3 mm	3,0 mm	4,0 mm	3,8 mm	3,5 mm	5,0 mm	4,0 mm
100-130 g	100-130 g	100-130 g	100-130 g	100-130 g	100-130 g	80-100 g	100-130 g



temporary

Kat. Nr.
 Cat. ref.
 No. de cat.
 Núm. de cat.

Maullänge
 Length of Jaws
 Longueur des mors
 Longitud de boca

Maulöffnung
 Opening of jaws
 Ouverture des mors
 Apertura de boca

Schließkraft
 Closing Force
 Force de fermeture
 Presión de oclusión

18-1471.30	18-1481.35	18-1483.35	18-1511.40	18-1513.38	18-1515.35
3,0 mm	5,0 mm	5,0 mm	7,0 mm	7,0 mm	7,0 mm
3,0 mm	3,5 mm	3,5 mm	4,0 mm	3,8 mm	3,5 mm
35-45 g	35-45 g	35-45 g	40-50 g	40-50 g	40-50 g



permanent

Kat. Nr.
Cat. ref.
No. de cat.
Núm. de cat.

Maullänge
Length of Jaws
Longueur des mors
Longitud de boca

Maulöffnung
Opening of jaws
Ouverture des mors
Apertura de boca

Schließkraft
Closing Force
Force de fermeture
Presión de oclusión

18-1420.55	18-1422.53	18-1424.48	18-1426.50	18-1426.68	18-1430.60	18-1432.60
7,0 mm	7,0 mm	7,0 mm	7,0 mm	7,0 mm	9,0 mm	9,0 mm
5,5 mm	5,3 mm	4,8 mm	5,0 mm	6,8 mm	6,0 mm	6,0 mm
110-140 g	110-140 g	110-140 g	110-140 g	110-140 g	110-140 g	110-140 g

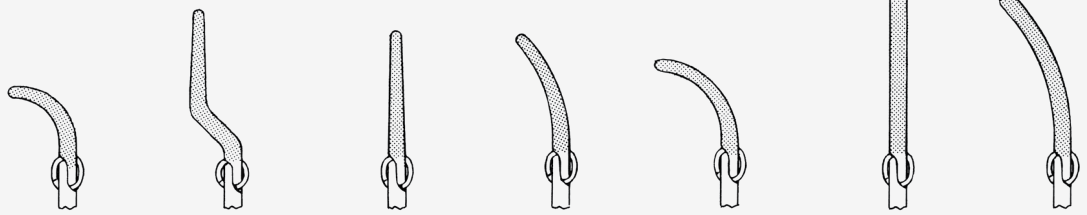

Kat. Nr.
Cat. ref.
No. de cat.
Núm. de cat.

Maullänge
Length of Jaws
Longueur des mors
Longitud de boca

Maulöffnung
Opening of jaws
Ouverture des mors
Apertura de boca

Schließkraft
Closing Force
Force de fermeture
Presión de oclusión

18-1434.50	18-1438.75	18-1440.68	18-1442.65	18-1444.58	18-1450.80	18-1452.75
9,0 mm	9,0 mm	11,0 mm	11,0 mm	11,0 mm	15,0 mm	15,0 mm
5,0 mm	7,5 mm	6,8 mm	6,5 mm	5,8 mm	8,0 mm	7,5 mm
110-140 g	110-140 g	110-140 g	110-140 g	110-140 g	100-130 g	100-130 g

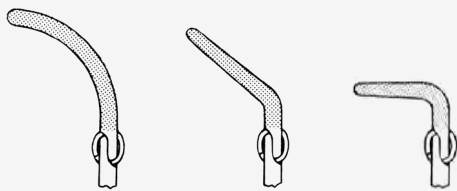

Kat. Nr.
Cat. ref.
No. de cat.
Núm. de cat.

Maullänge
Length of Jaws
Longueur des mors
Longitud de boca

Maulöffnung
Opening of jaws
Ouverture des mors
Apertura de boca

Schließkraft
Closing Force
Force de fermeture
Presión de oclusión

18-1454.65	18-1470.68	18-1480.38
15,0 mm	9,0 mm	7,0 mm
6,5 mm	6,8 mm	3,8 mm
100-130 g	110-140 g	110-140 g



temporary



Kat. Nr.
 Cat. ref.
 No. de cat.
 Núm. de cat.

Maullänge
 Length of Jaws
 Longueur des mors
 Longitud de boca

Maulöffnung
 Opening of jaws
 Ouverture des mors
 Apertura de boca

Schließkraft
 Closing Force
 Force de fermeture
 Presión de oclusión

18-1431.73

9,0 mm

7,3

40-50 g

18-1433.73

9,0 mm

7,3 mm

40-50 g

18-1435.63

9,0 mm

6,3 mm

40-50 g

18-1451.00

15,0 mm

10,0 mm

60-80 g



Kat. Nr.
 Cat. ref.
 No. de cat.
 Núm. de cat.

Maullänge
 Length of Jaws
 Longueur des mors
 Longitud de boca

Maulöffnung
 Opening of jaws
 Ouverture des mors
 Apertura de boca

Schließkraft
 Closing Force
 Force de fermeture
 Presión de oclusión

18-1453.93

15,0 mm

9,3 mm

60-80 g

18-1455.80

15,0 mm

8,0 mm

60-80 g

18-1461.12

20,0 mm

12,0 mm

80-100 g

18-1463.11

20,0 mm

11,5 mm

80-100 g



Anlegezangen
 Applying Forceps
 Pinces de poser
 Pinzas de aplicación

18-1572.21

MINI

18-1574.21

STANDARD

21 cm, 8 1/4"

Chapter 19

Table of Contents

Ophthalmologie / **p. 284 - 317**

Ophthalmology / **p. 284 - 317**

Ophthalmologie / **p. 284 - 317**

Oftalmología / **p. 284 - 317**







BARRAQUER (COLIBRI)

19-0100.03 3 cm, 1 1/4"

19-0100.04 4 cm, 1 1/2"



BOWMANN

19-0101.07

7 cm, 2 3/4"

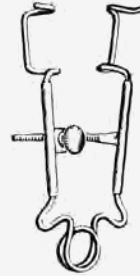

CRITCHETT

19-0102.07

7 cm, 2 3/4"



SMITH

19-0102.05

5 cm, 2"



CLARK

19-0103.08

8 cm, 3 1/4"



GRAEFE

19-0104.07 7 cm, 2 3/4"

19-0104.09 9 cm, 3 1/4"



WEEK

19-0105.08

8 cm, 3 1/4"

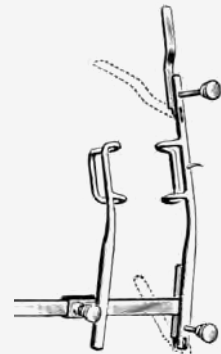

ARRUGA

19-0106.07

7 cm, 2 3/4"

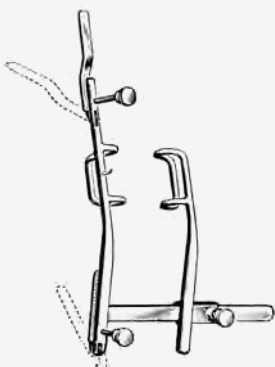

ARRUGA

19-0107.07

7 cm, 2 3/4"



MURDOCK

19-0108.05

5 cm, 2"



MELLINGER-AXENFELD

19-0110.07

7 cm, 2 3/4"

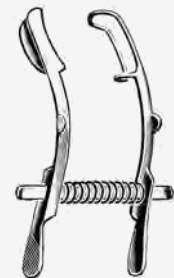

MELLINGER-AXENFELD

19-0111.07

7 cm, 2 3/4"



MELLINGER

19-0112.05 5 cm, 2"

19-0112.07 7 cm, 2 3/4"



LISTER-BURCH

19-0113.08

8 cm, 3 1/2"



WILLIAMS

19-0115.08

8 cm, 3 1/2"



LANCASTER

19-0130.07

7 cm, 2 3/4"



ZIEGLER

19-0132.07

7 cm, 2 3/4"



CASTROVIEJO

19-0190.08

8 cm, 3 1/2"



PARK

19-0192.08

8 cm, 3 1/4"



MUELLER

19-0193.07

7 cm, 2 3/4"



GOLDSTEIN

19-0194.03

3 cm, 1 1/4"



STEVENSON

19-0195.07

7 cm, 2 3/4"



JAEGER

19-0301.11

11 cm, 4 1/2"

Lidplatte
 Lid Plate
 Plaque à paupières
 Placa para párpados



19-1120.00
 Fig. 0

19-1120.01
 Fig. 1

19-1120.02
 Fig. 2

19-1120.03
 Fig. 3

Starmesser
 Cataract Knives
 Couteaux à cataracte
 Cuchillos para catarata

Starmesser
 Cataract Knife
 Couteaux à cataracte
 Cuchillo para catarata

GRAEFE

DEUTSCHMANN

19-1142.13

13 cm, 5"

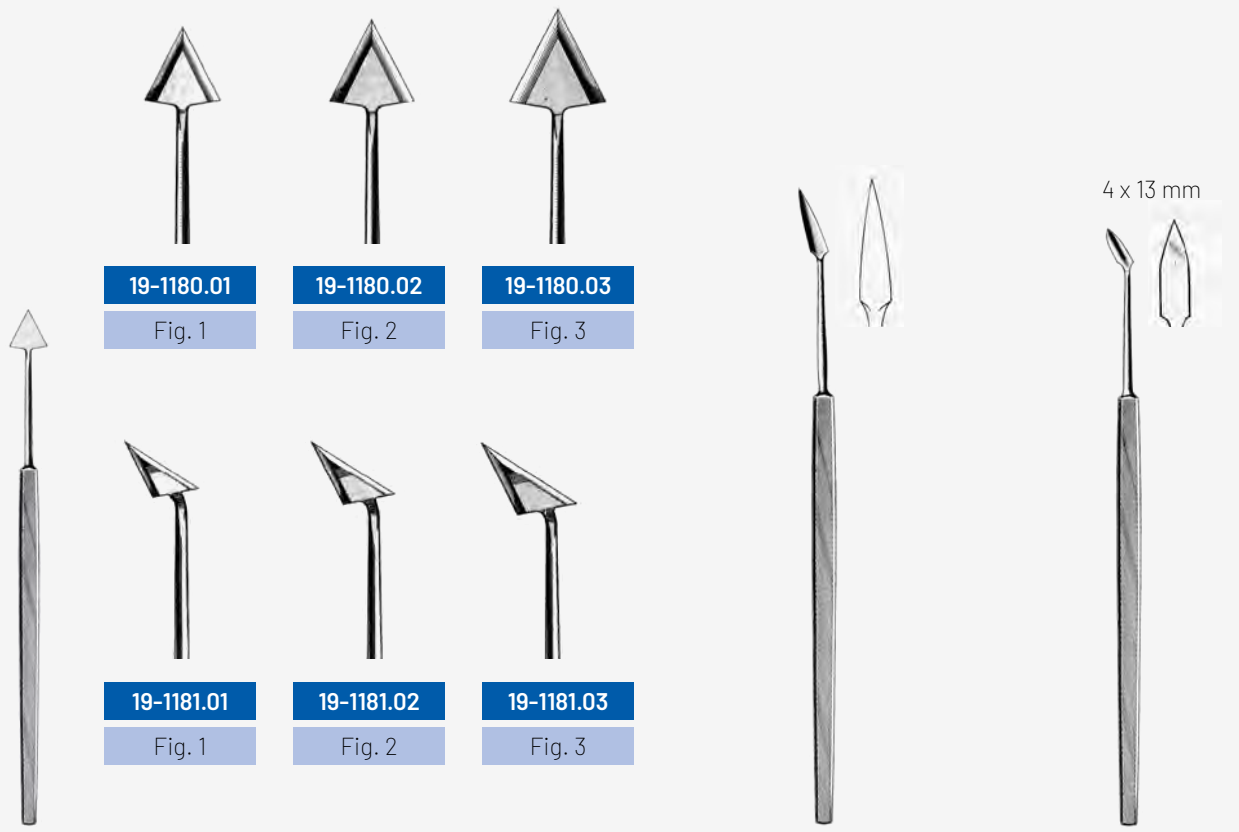

19-1180.01
 Fig. 1

19-1180.02
 Fig. 2

19-1180.03
 Fig. 3

19-1181.01
 Fig. 1

19-1181.02
 Fig. 2

19-1181.03
 Fig. 3



4 x 13 mm



JAEGER

BERENS

CASTROVIEJO

19-1183.13

19-1185.13

13 cm, 5"

13 cm, 5"



GRAEFE
19-1187.13
13 cm, 5"



KNAPP



19-1202.01
Fig. 1



19-1202.02
Fig. 2



19-1202.03
Fig. 3



DEAN
19-1211.12
12,5 cm, 5"



ZIEGLER

5 mm



19-1210.01
Fig. 1

6 mm



19-1210.02
Fig. 2

7 mm



19-1210.03
Fig. 3

0,4 mm



19-1214.04

0,8 mm



19-1214.08



BOWMANN
13 cm, 5"



WHEELER

19-1218.12

12 cm, 4 3/4"



ZIEGLER

19-1221.11

11 cm, 4 1/2"



SATO

19-1226.12

12,5 cm, 5"



TOOK

19-1228.12

12 cm, 4 3/4"



GILL

19-1231.12

12 cm, 4 3/4"

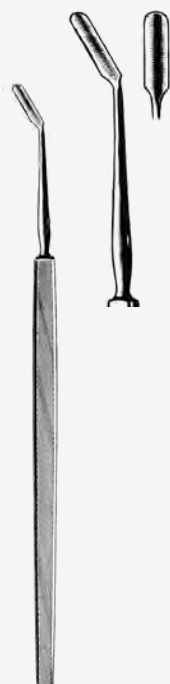

ELSCHMIG

19-1233.13

13 cm, 5"



PATON

19-1245.12

12 cm, 4 3/4"



LUNDSGAARD

19-1253.12

12 cm, 4 3/4"



GUYTON-LUNDSGAARD
19-1253.12
 12 cm, 4 3/4"



KUHNT

19-1240.01
 Fig. 1

19-1240.02
 Fig. 2

19-1240.03
 Fig. 3

19-1240.04
 Fig. 4



BARRKAN
19-1256.12
 12 cm, 4 3/4"



SCHEIE
19-1258.12
 12 cm, 4 3/4"



BURCH
19-1262.12
 12 cm, 4 3/4"



PAUFIQUE
19-1271.11
 11 cm, 4 1/2"



BARRAQUER
 19-1273.13
 13 cm, 5"

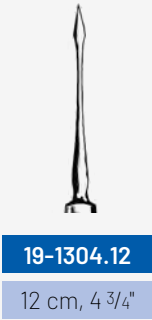

19-1304.12
 12 cm, 4 3/4"

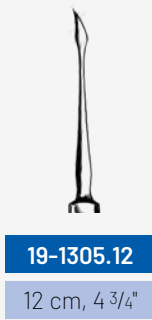

19-1305.12
 12 cm, 4 3/4"



19-1310.13
 13 cm, 5"



19-1311.13
 13 cm, 5"



BOWMANN



19-1208.12
 12 cm, 4 3/4"



19-1209.12
 12 cm, 4 3/4"



LEVINSON
 19-1314.13
 13 cm, 5"



FRANCIS
 19-1321.12
 12 cm, 4 3/4"



DAVIS
 19-1325.13
 13 cm, 5"





LA FORCE

19-1327.12

12 cm, 4 3/4"



DIX

19-1330.13

13 cm, 5"



ELLIS

19-1331.11

11 cm, 4 1/2"



WALTON

19-1332.12

12 cm, 4 3/4"



WALTON

19-1334.12

12 cm, 4 3/4"



ALVIS

19-1336.12

12 cm, 4 3/4"

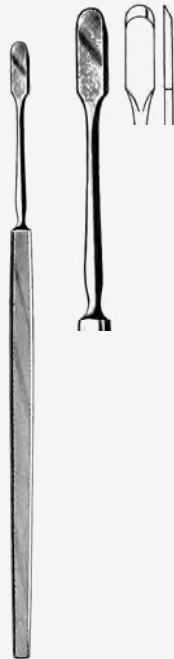

GREEN

19-1340.13

13 cm, 5"



ROLLET

19-1342.12

12 cm, 4 3/4"



JAMESON

19-1353.13

13 cm, 5"



GREEN

19-1355.13

13 cm, 5"



19-1351.01

Fig. 1

GRAEFE



19-1351.02

Fig. 2



19-1351.03

Fig. 3



19-1363.01

Fig. 1

ARRUGA



19-1363.02

Fig. 2

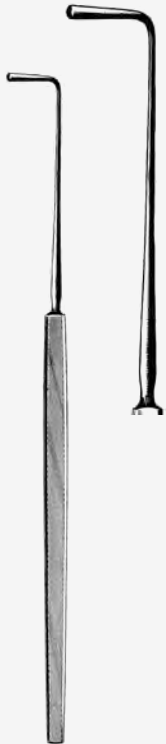

STEVENS

19-1357.13

13 cm, 5"



O'CONNOR

19-1370.12

12 cm, 4 3/4"



WIENER

19-1372.13

13 cm, 5"



WIENER

19-1373.13

13 cm, 5"

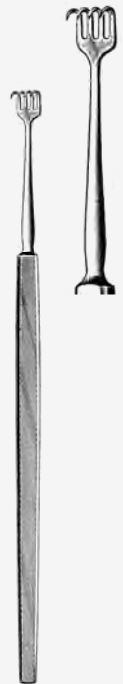

ROLLET

19-1376.13

13 cm, 5"



KNAPP

19-1377.13

13 cm, 5"



GRAEFE

19-1380.13

13 cm, 5"



19-1381.13

13 cm, 5"



19-1383.13

13 cm, 5"



BECKER

19-1386.13

13 cm, 5"

Chalazions- und Starlöffel

Scoops and Curettes for Chalazion and Cataract

Curettes et cuillers pour chalazion et cataracte

Curetas y cucharillas para chalazión y catarata



MEYHOEFER



19-1402.05

Ø 0,5 mm



19-1402.10

Ø 1,0 mm



19-1402.15

Ø 1,5 mm



19-1402.18

Ø 1,8 mm

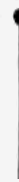

19-1402.20

Ø 2,0 mm



19-1402.25

Ø 2,5 mm



19-1402.35

Ø 3,5 mm

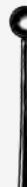

19-1402.40

Ø 4,0 mm



19-1402.45

Ø 4,5 mm

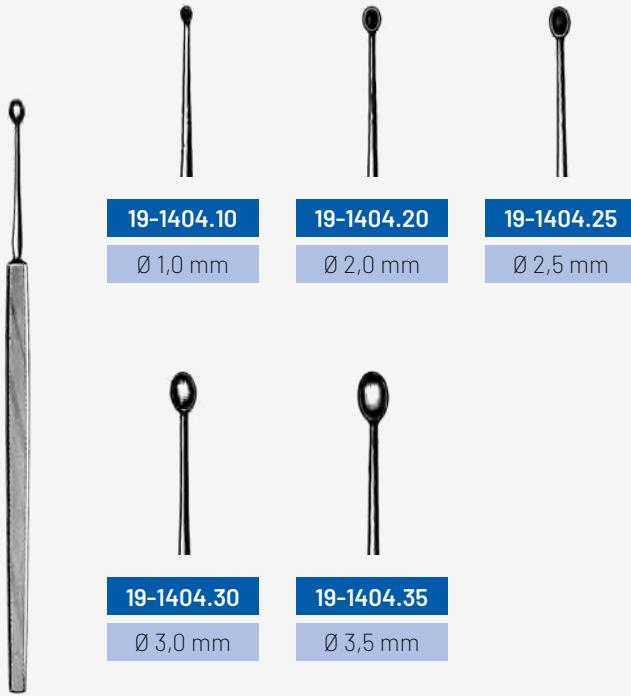

19-1404.10

Ø 1,0 mm

19-1404.20

Ø 2,0 mm

19-1404.25

Ø 2,5 mm

19-1404.30

Ø 3,0 mm

19-1404.35

Ø 3,5 mm

HEBRA

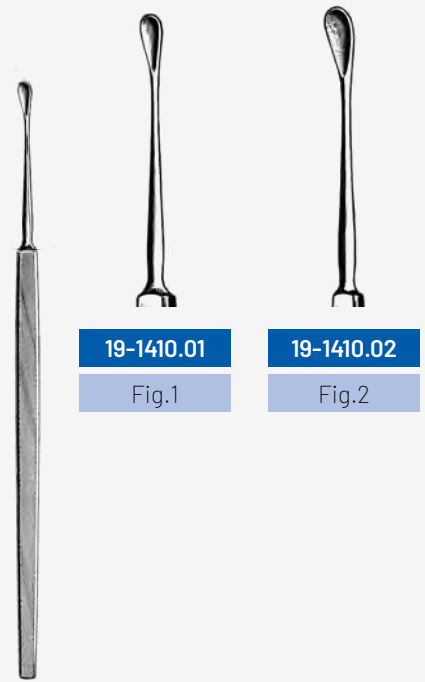

19-1410.01

Fig.1

19-1410.02

Fig.2

GRAEFE



19-1412.01

Fig.1

19-1412.02

Fig.2

19-1420.01

Fig.1

19-1420.02

Fig.2

19-1420.03

Fig.2

DAVIEL

BUNGE



AXENFELD
 19-1407.13
 13 cm, 5"

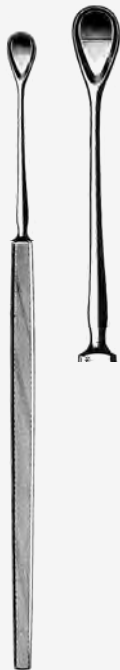

KNAPP
 19-1414.02



LANG
 19-1424.13
 13 cm, 5"



WEBER



19-1441.01
 Fig. 1



19-1441.02
 Fig. 2

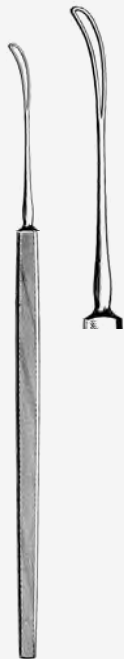

SNELLEN
 19-1443.13
 13 cm, 5"

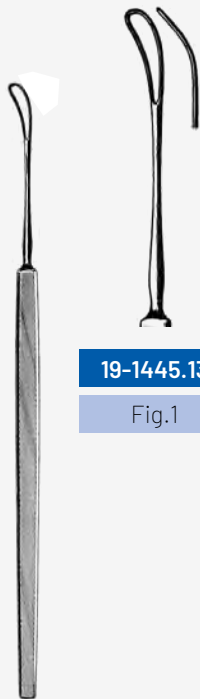

19-1445.13
 Fig.1



19-1447.13
 Fig.2



ARLT



19-1449.01
 Fig.1



19-1449.02
 Fig.2

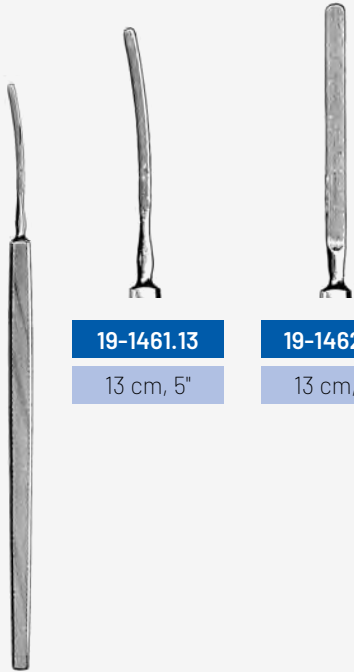

19-1461.13

13 cm, 5"

19-1462.13

13 cm, 5"

WECKER

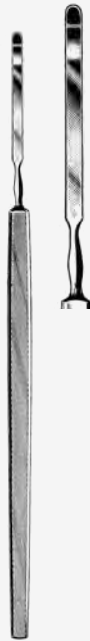

CULLER

19-1467.13

13 cm, 5"



ARRUGA

19-1485.13

13 cm, 5"

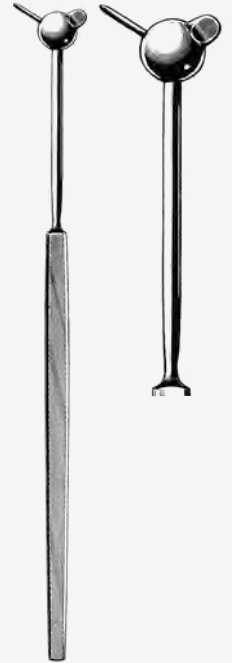

WADSWORTH-TODD

19-1487.14

14 cm, 5 1/2"

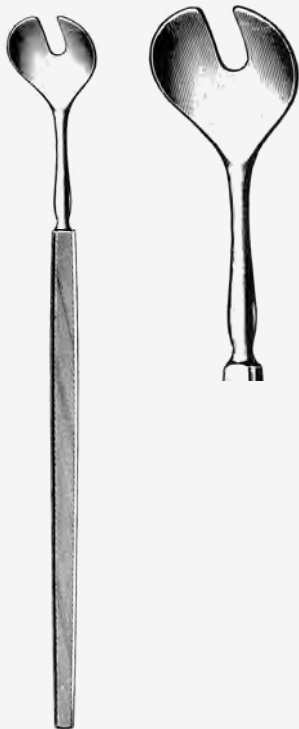

WELLS

19-1482.20

20 cm, 8"

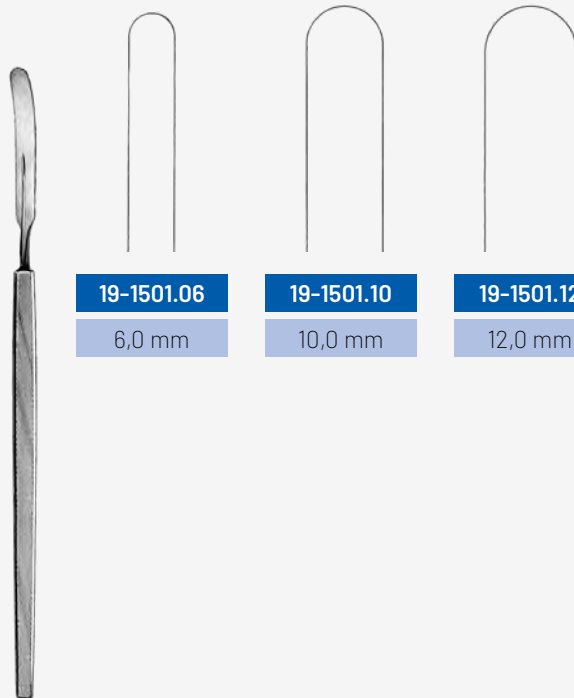

BANGERTER

19-1501.06

6,0 mm

19-1501.10

10,0 mm

19-1501.12

12,0 mm

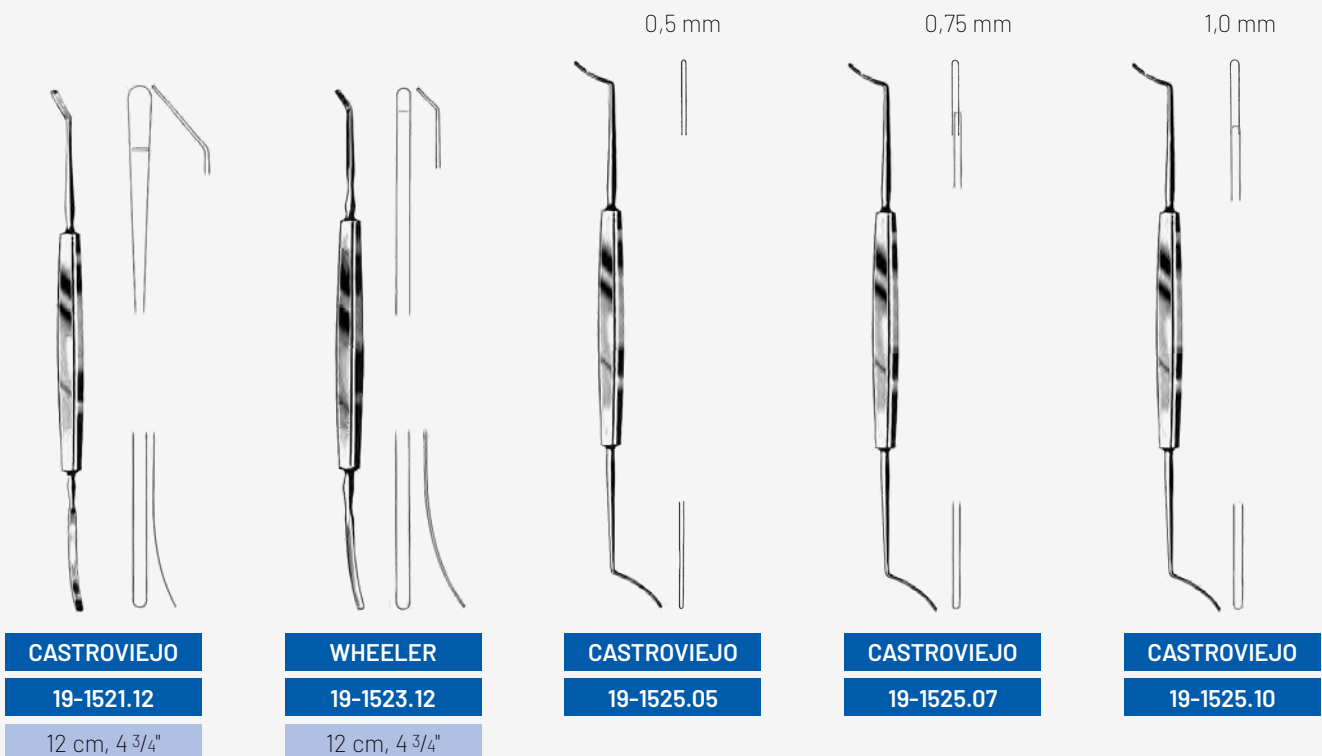



DIX

19-1542.12

12 cm, 4 3/4"



DIX

19-1544.12

12 cm, 4 3/4"



DIX

19-1546.13

13 cm, 5"



DIX

19-1548.13

13 cm, 5"

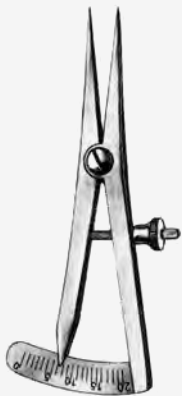

CASTROVIEJO

19-1583.07

0 - 20 mm



CONNIN-AMSLER

19-1589.13

13 cm, 5"



DASTOOR

19-1590.06

6 cm, 2 1/4"



HOLTH

19-1593.09

9 cm, 3 1/2"



WILDER

19-1602.01

Fig. 1



WILDER

19-1602.02

Fig. 2



WILDER

19-1602.03

Fig. 3



ZIEGLER

19-1605.12 Fig. 1/2

19-1605.34 Fig. 3/4

19-1605.56 Fig. 5/6



CASTROVIEJO

19-1608.12

12 cm, 4 3/4"



BOWMANN

19-1614.00 Fig. 00/0

19-1614.01 Fig. 0/1

19-1614.12 Fig. 1/2

19-1614.23 Fig. 2/3

19-1614.34 Fig. 3/4

19-1614.45 Fig. 4/5

19-1614.56 Fig. 5/6

19-1614.67 Fig. 6/7

19-1614.78 Fig. 7/8



BOWMANN

19-1616.00 Fig. 00/0

19-1616.01 Fig. 0/1

19-1616.12 Fig. 1/2

19-1616.23 Fig. 2/3

19-1616.34 Fig. 3/4

19-1616.45 Fig. 4/5

19-1616.56 Fig. 5/6

19-1616.67 Fig. 6/7

19-1616.78 Fig. 7/8



GRAEFE

19-7020.07

7 cm, 2 3/4"



GRAEFE

19-7021.07

7 cm, 2 3/4"

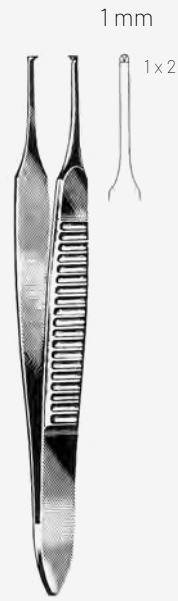

GRAEFE

19-7022.07

7 cm, 2 3/4"



GRAEFE

19-7023.07

7 cm, 2 3/4"



GRAEFE

19-7010.01

10 cm, 4"



GRAEFE

19-7011.01

10 cm, 4"



GRAEFE

19-7011.02

10 cm, 4"



GRAEFE

19-7012.01

10 cm, 4"



GRAEFE

19-7013.01

10 cm, 4"



GRAEFE

19-7013.02

10 cm, 4"



1x2



1x2



1x2



STEVENS

19-7030.01

10,5 cm, 4"

STEVENS

19-7031.01

10,5 cm, 4"

STEVENS

19-7031.02

10,5 cm, 4"

STEVENS

19-7032.01

10,5 cm, 4"

STEVENS

19-7033.01

10,5 cm, 4"

STEVENS

19-7033.02

10,5 cm, 4"



1x2

1x2

FOERSTER

19-7120.08

8,5 cm, 3 1/2"

FOERSTER

19-7121.08

8,5 cm, 3 1/2"

FOERSTER

19-7122.08

8,5 cm, 3 1/2"

FOERSTER

19-7123.08

8,5 cm, 3 1/2"



HESS

19-7061.07

7 cm, 2 3/4"



HESS

19-7063.07

7 cm, 2 3/4"



GILL

19-7091.07

7,5 cm, 3"



FISCHER

19-7081.07

7 cm, 2 3/4"



GILL-HESS

19-7093.07

7,5 cm, 3"



GILL-HESS

19-7095.07

7,5 cm, 3"



BARRAQUER-KATZIN

19-7231.07

7 cm, 2 3/4"



TROUTMAN (COLIBRI)

19-7233.07

7 cm, 2 3/4"

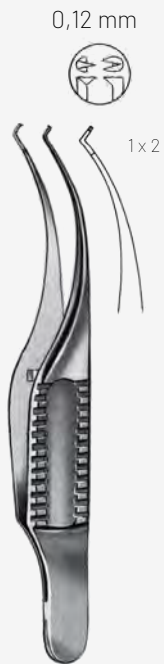

BARRAQUER (COLIBRI)

19-7235.07

7 cm, 2 3/4"

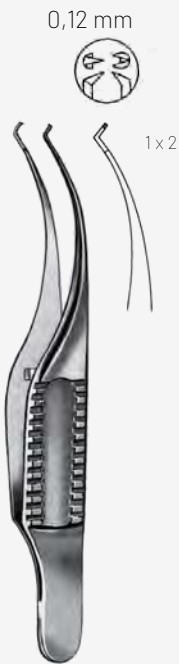

BARRAQUER (COLIBRI)

19-7237.07

7 cm, 2 3/4"



MC CULLOUGH

19-7840.09

9,5 cm, 3 3/4"



MC CULLOUGH

19-7842.09

9,5 cm, 3 3/4"



JAMESON

19-7810.01

10 cm, 4"

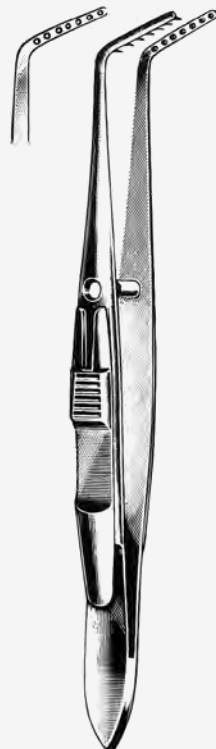

JAMESON

19-7810.02

10 cm, 4"



BONACCOLTO

19-7812.10

10 cm, 4"



BONACCOLTO

19-7814.10

10 cm, 4"



BONACCOLTO

19-7816.11

11 cm, 4 1/4"



KIRBY-ARTUR

19-7801.09

9 cm, 3 1/2"



DASTOOR

19-7818.11

11 cm, 4 1/4"



1x2

DASTOOR

19-7820.11

11 cm, 4 1/4"

0,5 mm



BISHOP-HARMAN

19-7102.08

8,5 cm, 3 1/2"

0,8 mm



BISHOP-HARMAN

19-7104.08

8,5 cm, 3 1/2"

0,5 mm



1x2

BISHOP-HARMAN

19-7106.08

8,5 cm, 3 1/2"

0,8 mm



1x2

BISHOP-HARMAN

19-7108.08

8,5 cm, 3 1/2"



MOD. BONN

19-7050.07

7 cm, 2 3/4"



MOD. BONN

19-7052.07

7 cm, 2 3/4"

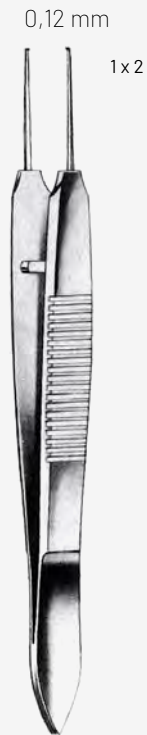

MOD. BONN

19-7054.10

10 cm, 4"



TROUTMAN

19-7757.08

8,5 cm, 3 1/2"



MOD. TÜBINGEN

19-7570.10

10 cm, 4"



MOD. BONN

19-7576.10

10 cm, 4"



Spitzen
 Hartmetall beschichtet

Tips Tungsten
 Carbide coated

MOD. TÜBINGEN

19-7571.10

10 cm, 4"



PRINCE

19-7751.10

10 cm, 4"



PRINCE

19-7753.10

10 cm, 4"



BERKE

10 cm, 4"



19-7755.20

20 mm



19-7755.27

27 mm



7 mm

Vorkammer-Pinzette
 Anterior Chamber Forceps
 Pince à chambre antérieure
 Pinza para cámara anterior

BARRAQUER

19-7875.05

5,5 cm, 2 1/4"



ELSCHMIG

19-7710.11

11 cm, 4 1/2"



ohne Schloß
 without catch
 sans crémaillère
 sin cierre

GRAEFE

19-5020.11

11 cm, 4 1/2"



mit Schloß
 with catch
 à crémaillère
 con cierre

GRAEFE

19-5022.11

11 cm, 4 1/2"



LESTER

19-7720.09

9,5 cm, 3 3/4"



CASTROVIEJO

19-7702.09

9 cm, 3 1/2"



CASTROVIEJO

19-7703.09

9 cm, 3 1/2"



CASTROVIEJO

19-7704.09

9 cm, 3 1/2"



CASTROVIEJO

19-7705.09

9 cm, 3 1/2"

19

Fixier-Pinzetten, Kapsel-Pinzetten
Fixation Forceps, Capsular Forceps
 Pinces à fixation, Pincas capsulaires
 Pinzas para fijación, Pinzas capsulares



BARRAQUER

19-7730.09

10 cm, 4"



GREEN

10 cm, 4"



19-5010.05

5 mm



19-5010.10

10 mm

ohne Schloß
 without catch
 sans crémaillère
 sin cierre



19-5012.05

5 mm



19-5012.10

10 mm

mit Schloß
 with catch
 à crémaillère
 con cierre



GILL-ARRUGA

19-7427.07

7,5 cm, 3"



TERSON

19-7457.09

9 cm, 3 1/2"



KALT

19-7411.10

10 cm, 4"



ELSCHMIG

19-7412.10

10 cm, 4"



ARRUGA

19-7421.10

10 cm, 4"



ARRUGA

19-7423.10

10 cm, 4"



CASTROVIEJO

19-7405.10

10 cm, 4"



SCHWEIGGER

19-7451.10

10 cm, 4"



SCHWEIGGER

19-7453.10

10 cm, 4"



ELSCHNIG

19-7455.10

10 cm, 4"



HESS

19-7475.06

6 cm, 2 1/2"



HESS

19-7477.06

6 cm, 2 1/2"



FUCHS

19-7463.07

7 cm, 2 3/4"



19-7210.01	0,12 mm
19-7210.03	0,30 mm
19-7210.05	0,50 mm
19-7210.10	1,00 mm
19-7210.15	1,50 mm

CASTROVIEJO
 10 cm, 4"



19-7211.05	0,50 mm
19-7211.10	1,00 mm
19-7211.15	1,50 mm

CASTROVIEJO
 10 cm, 4"



MOORFIELD
 19-7244.10
 10 cm, 4"

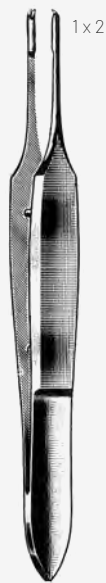

ST. MARTIN
 19-7240.07
 7 cm, 2 3/4"



MOD. TÜBINGEN
 19-7242.10
 10 cm, 4"



PAUFIQUE

19-7250.08

8,5 cm, 3 1/2"



PAUFIQUE

19-7252.08

8,5 cm, 3 1/2"



MC PHERSON

19-7255.10

10 cm, 4"



MC PHERSON

19-7257.10

10 cm, 4"



AYER
19-7620.09
 9 cm, 3 1/2"



AYER
19-7622.09
 9 cm, 3 1/2"



LAMBERT
19-7636.09
 9 cm, 3 1/2"

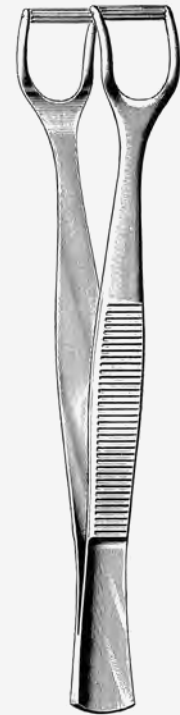

KNAPP-LUER
19-7362.11
 11 cm, 4 1/4"



19-7609.01
 Fig. 1



19-7609.02
 Fig. 2



19-7609.03
 Fig. 3

DESMARRES
 9 cm, 3 1/2"



SNELLEN
19-7360.01
 10 cm, 4"



SNELLEN
19-7360.02
 10 cm, 4"



SCHEIE

19-3515.28

1,0 x 28 mm



SCHEIE

19-3516.28

1,5 x 33 mm



MOD. TÜBINGEN

19-3517.45



MOD. HAMBURG

19-3518.00



SIMCOE

19-3519.00



MOD. BONN

19-3520.00



MOD. BONN

19-3521.00

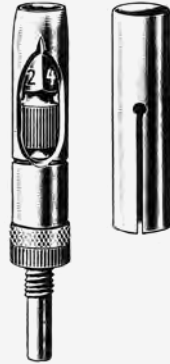

CASTROVIEJO	
19-2850.50	5,0 mm
19-2850.55	5,5 mm
19-2850.60	6,0 mm
19-2850.65	6,5 mm
19-2850.70	7,0 mm
19-2850.80	8,0 mm
19-2850.90	9,0 mm
19-2851.00	10,0 mm
19-2851.01	11,0 mm



ELLIOT
 19-2810.00



Tonometer
 Tonometer
 Tonomètre
 Tonómetro

SCHIOETZ
 19-3910.00

gerade Scala
 straight scale
 échelle droite
 escala recta

SCHIOETZ
 19-3912.00

schräge Scala
 scale oblique
 échelle oblique
 escala oblicua

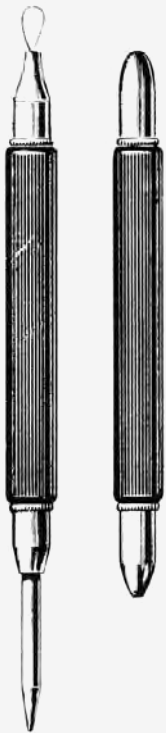

Fremdkörperschlinge
 und Magnet

Foreign Body Remover
 and Magnetic Eye Probe

Anse et aimant pour
 corps étrangers

Asa e ímán para cuerpos
 extraños

19-1750.17

17 cm, 6 3/4"



BEER

19-7924.09

9 cm, 3 1/2"



DOUGLAS

19-7910.09

9 cm, 3 1/2"



LITTAUER

19-7916.08

8,5 cm, 3 1/2"



BARRAQUER

19-7951.10

10,5 cm, 4 1/4"



19-7936.09

9 cm, 3 1/2"



GRADLE

19-7940.09

9,5 cm, 3 3/4"

Chapter 20

Table of Contents

Otologie / p. 318 - 340

Otology / p. 318 - 340

Otologie / p. 318 - 340

Otología / p. 318 - 340





20

Ohr-Spekula
Ear Specula
 Spéculums auriculaires
 Espéculos auriculares



HARTMANN	
20-2010.30	3,0 mm
20-2010.45	4,5 mm
20-2010.55	5,5 mm
20-2010.65	6,5 mm
20-2010.75	7,5 mm

HARTMANN-SET
20-2010.00
4,5 mm - 7,5 mm



TOYNBEE	
20-2012.55	5,5 mm
20-2012.65	6,5 mm
20-2012.75	7,5 mm

TOYNBEE-SET
20-2012.00
5,5 mm - 7,5 mm



GRUBER	
20-2014.45	4,5 mm
20-2014.55	5,5 mm
20-2014.65	6,5 mm
20-2014.75	7,5 mm

GRUBER-SET
20-2014.00
4,5 mm - 7,5 mm



GRUBER	
20-2015.45	4,5 mm
20-2015.55	5,5 mm
20-2015.65	6,5 mm
20-2015.75	7,5 mm

GRUBER-SET
20-2015.00
4,5 mm - 7,5 mm



BOUCHERON	
20-2018.50	5,0 mm
20-2018.60	6,0 mm
20-2018.70	7,0 mm
20-2018.80	8,0 mm

BOUCHERON-SET
20-2018.00
5,0 mm - 8,0 mm

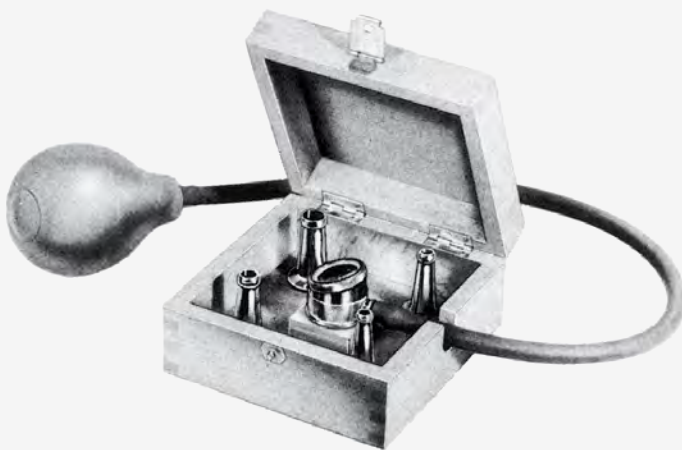

BRUENINGS-SET
 20-2030.04



SIEGLE-SET
 20-2036.03

20

Stimmgabeln
Tuning Forks
Diapasons
Diapasones



HARTMANN
20-3570.01
C 128



HARTMANN
20-3570.02
C1 256



HARTMANN
20-3570.03
C2 512



HARTMANN
20-3570.04
C3 1024



HARTMANN
20-3570.05
C4 2048



HARTMANN
20-3571.00



LUCAE
 20-3874.01
 C 128



20-4075.00
 neurol.



RYDEL-SEIFFER
 20-4076.01
 C 64 / C 128

Lärmtrommel
 Noise Apparatus
 Assourdisseur
 Ensordecedor



BARANY
 20-4080.00

Pulverbläser
 Powder Blowers
 Lance-Poudre
 Lanzapolvo

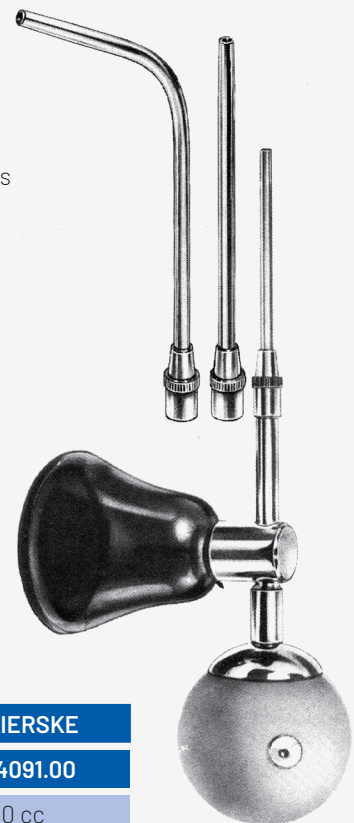

KABIERSKE
 20-4091.00
 30 cc



Luftdusche
 Air Bag
 Insufflateur d'air
 Insuflador de aire



20-4191.03
 Ø 3 mm



20-4191.04
 Ø 4 mm



20-4191.15
 Ø 15 mm



20-4191.17
 Ø 17 mm



20-4191.22
 Ø 22 mm

POLITZER
20-4191.00
incl. 20-4191.03 20-4191.15 20-4191.17 20-4191.22

POLITZER
20-4191.01
incl. 20-4191.03 20-4191.04 20-4191.15 20-4191.17 20-4191.22

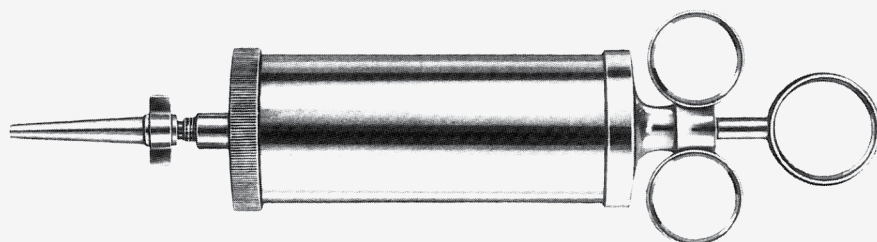

REINER	
20-4596.50	50 ml
20-4596.75	75 ml
20-4597.10	100 ml
20-4597.15	150 ml





HARTMANN	
20-4631.00	Fig. 0
20-4631.01	Fig. 1
20-4631.02	Fig. 2
20-4631.03	Fig. 3
20-4631.04	Fig. 4
20-4631.05	Fig. 5





ITARD	
20-4633.01	Fig. 1
20-4633.02	Fig. 2
20-4633.03	Fig. 3
20-4633.04	Fig. 4
20-4633.05	Fig. 5





 Fig. 00



 Fig. 0

 Fig. 1



 Fig. 2

 Fig. 3



 Fig. 4

 Fig. 5

stumpf
blunt
mousses
romas



scharf
sharp
tranchantes
cortantes



stumpf
blunt
mousses
romas



scharf
sharp
tranchantes
cortantes



Fig. 00	20-4609.00	20-4611.00	20-4614.00	20-4616.00
Fig. 0	20-4610.00	20-4612.00	20-4615.00	20-4617.00
Fig. 1	20-4610.01	20-4612.01	20-4615.01	20-4617.01
Fig. 2	20-4610.02	20-4612.02	20-4615.02	20-4617.02
Fig. 3	20-4610.03	20-4612.03	20-4615.03	20-4617.03
Fig. 4	20-4610.04	20-4612.04	20-4615.04	20-4617.04
Fig. 5	20-4610.05	20-4612.05	20-4615.05	20-4617.05

BUCK
 16,5 cm, 6 1/2"



POLITZER
20-4650.18
 18 cm, 7"



POLITZER
20-4651.16
 16 cm, 6 1/4"

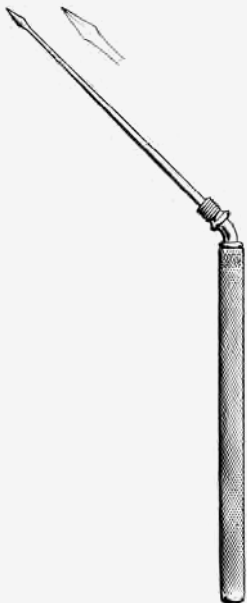

POLITZER
20-4653.16
 16 cm, 6 1/4"



POLITZER
20-4660.15
 15 cm, 5 3/4"



SEXTON
 20-4662.18
 18 cm, 7"



SEXTON
 20-4664.17
 17 cm, 6 3/4"



SEXTON
 20-4665.17
 17 cm, 6 3/4"



GROSS
 20-4670.12
 12 cm, 4 3/4"



GROSS
 20-4671.12
 12 cm, 4 3/4"



BILLEAU
 16,5 cm, 6 1/2"



20-4680.01
 Fig. 1



20-4680.02
 Fig. 2



20-4680.03
 Fig. 3



DAY
 20-4690.01
 16 cm, 6 1/4"



DAY
 20-4690.02
 16 cm, 6 1/4"



WAGENER
 14 cm, 5 1/2"

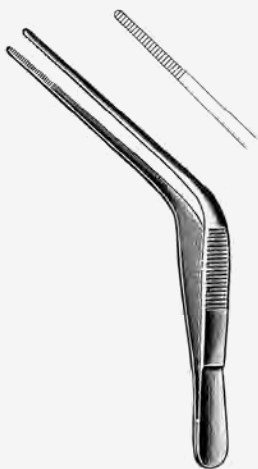
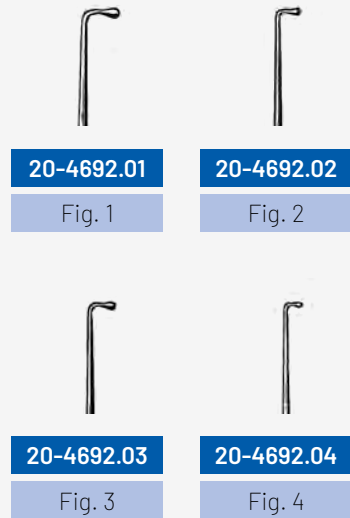

WILDE (TROELTSCH)
 20-4701.12
 12 cm, 4 3/4"



WILDE (TROELTSCH)
 20-4703.12
 12 cm, 4 3/4"



LUCAE
 20-4706.14
 14 cm, 5 1/2"



LUCAE
 20-4706.16
 16 cm, 6 1/4"

20

Schnürer, Ohrzängchen
Snares, Ear Forceps
Serrenoed, Pincas auriculaires
Cierranudos, Pinzas auriculares



KRAUSE

20-4720.16

16 cm, 6 1/4"

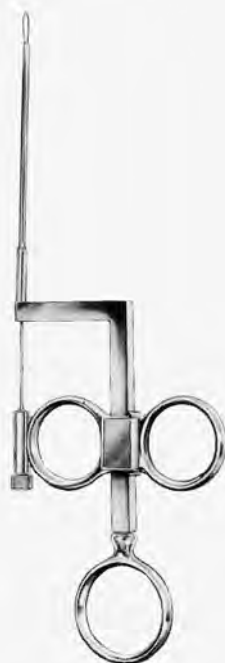

WILDE

20-4722.17

17 cm, 6 3/4"



20-4725.02

Dtzd. / doz. / douz / doc.



HARTMANN

20-4841.12

12 cm, 4 3/4"



HARTMANN

20-4841.14

14 cm, 5 1/2"



TILLEY

20-4843.14

14 cm, 5 1/2"



LITTAUER

20-4845.12

12 cm, 4 3/4"



QUIRE
20-4851.10
 10 cm, 4"

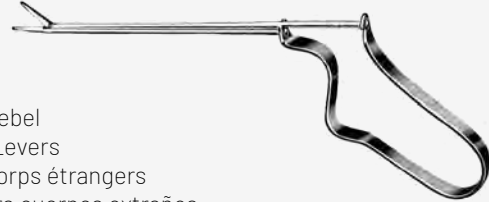

BUCK
20-4853.11
 11 cm, 4 1/2"

Fremdkörperheber
 Foreign Body Levers
 Leviers pour corps étrangers
 Elevadores para cuerpos extraños



20-4861.08 8,5 cm, 3 1/4"
20-4861.14 14 cm, 5 1/2"
20-4861.16 16 cm, 6 1/4"



20-4865.08
 8,5 cm, 3 1/4"



20-4873.08
 8,5 cm, 3 1/4"



20-4863.08 8,5 cm, 3 1/4"
20-4863.14 14 cm, 5 1/2"



Ø 3,0 mm
20-4869.30
 8,5 cm, 3 1/4"



20-4867.20 8,5 cm, 3 1/4" 2,0 mm
20-4867.25 14 cm, 5 1/2" 2,5 mm
20-4867.30 16 cm, 6 1/4" 3,0 mm



HARTMANN

20

Ohrzängchen und -Scheren
Ear Forceps and Scissors
 Pincas et ciseaux auriculaires
 Pinzas y tijeras auriculares



HARTMANN-WULLSTEIN

20-4857.08



HARTMANN-WULLSTEIN

20-4855.08



STRUEMPEL

20-4871.08



HARTMANN-HOFFMANN

20-4875.08

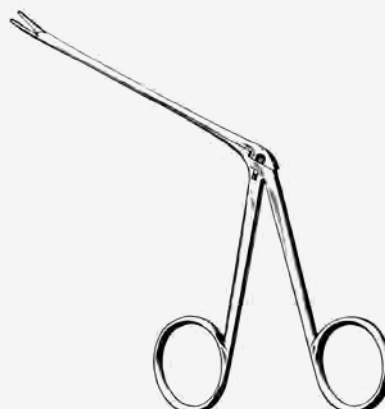

8,5 cm, 3 1/4"



20-5010.40

4,0 mm



20-5012.55

5,5 mm



20-5013.55

5,5 mm



20-5015.55

5,5 mm



20-5017.55

5,5 mm

80 mm
 Mikro Ohrscheren
 Micro Ear Scissors
 Ciseaux auriculaires micro
 Tijeras auriculares micro



BELLUCCI



20-5020.70

7,0 mm



20-5021.70

7,0 mm



20-5022.70

7,0 mm

80 mm
 Mikro Ohrscheren
 Micro Ear Scissors
 Ciseaux auriculaires micro
 Tijeras auriculares micro



SHEA



20-5050.40

4,0 mm



20-5070.70

7,0 mm



20-5052.40

4,0 mm



20-5053.60

6,0 mm



20-5055.60

6,0 mm

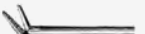

20-5057.40

4,0 mm



20-5059.40

4,0 mm



20-5060.35

3,5 mm



20-5062.45

4,5 mm



20-5063.45

4,5 mm



20-5065.45

4,5 mm



20-5067.50

5,0 mm



20-5069.50

5,0 mm



GREVEN

20-5070.50

5,0 mm



MC GEE

20-5071.40

0,8 x 4,0 mm



COS

20-5073.30

1,8 x 0,8 x 3,0 mm



JUERS

20-5075.60

6,0 mm



JUERS

20-5077.60

6,0 mm



HAUGH

20-5081.30

45°, 3,0 mm



HAUGH



20-5083.30

45°, 3,0 mm

Drahtbiegezängchen
 Wire closure forceps
 Pincès à plier le fil métallique
 Pinzas para doblar alambre

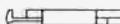
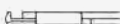

Hammerkopf-Zwickzängchen
 Malleus Nippers
 Pincettes pour la tête du marteau
 Pinzas para la cabeza del martillo

	20-5085.01	micro	aufwärts upward
	20-5087.01	mini	en haut arriba
	20-5085.02	micro	abwärts downward
	20-5087.02	mini	en bas abajo

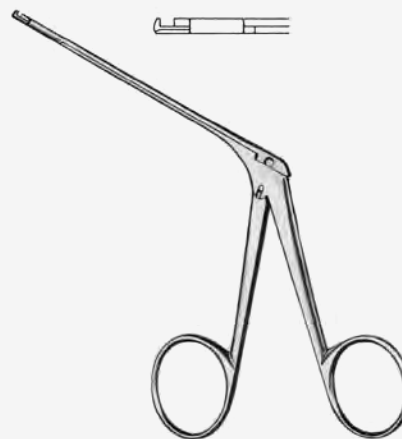

DIETER

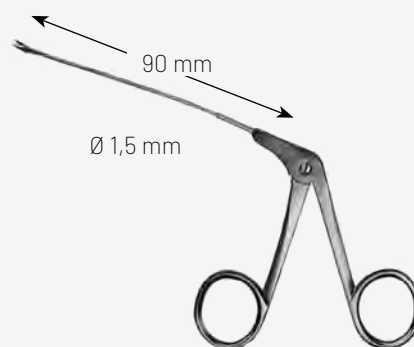



20-5120.00



20-5122.00



20-5123.00



20-5125.00



20-5127.00



20-5129.00



20-5130.00



20-5132.00



20-5133.00



20-5135.00



20-5137.00



20-5139.00



20-5139.08

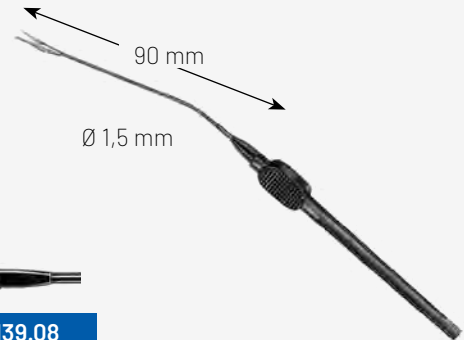

20-5140.00



20-5142.00



20-5143.00



20-5145.00



20-5147.00



20-5149.00

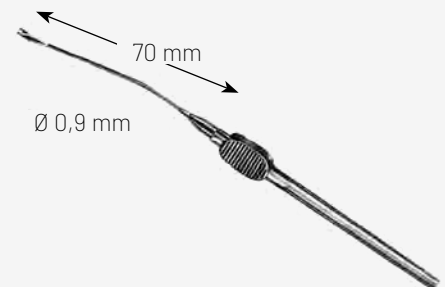

20

Ohrzängchen
Ear Forceps
 Pinces auriculaires
 Pinzas auriculares



20-5210.00



20-5211.00



20-5213.00



20-5214.00



20-5215.00



20-5216.00



20-5217.00



20-5219.00

1 x 2



20-5220.00



20-5221.00



20-5310.00



20-5311.00



20-5313.00



20-5314.00



20-5315.00



20-5316.00



20-5317.00



20-5319.00

1 x 2



20-5320.00



20-5222.00 Ø 1,0 mm



20-5223.00 Ø 1,0 mm

20-5228.00 Ø 1,5 mm

20-5229.00 Ø 1,5 mm

20-5234.00 Ø 2,0 mm

20-5235.00 Ø 2,0 mm

20-5240.00 Ø 2,5 mm

20-5241.00 Ø 2,5 mm



20-5225.00 Ø 1,0 mm



20-5227.00 Ø 1,0 mm

20-5231.00 Ø 1,5 mm

20-5233.00 Ø 1,5 mm

20-5237.00 Ø 2,0 mm

20-5239.00 Ø 2,0 mm

20-5243.00 Ø 2,5 mm

20-5245.00 Ø 2,5 mm





20-5322.00	Ø 1,0 mm
20-5328.00	Ø 1,5 mm
20-5334.00	Ø 2,0 mm
20-5340.00	Ø 2,5 mm



20-5323.00	Ø 1,0 mm
20-5329.00	Ø 1,5 mm
20-5335.00	Ø 2,0 mm
20-5341.00	Ø 2,5 mm



20-5325.00	Ø 1,0 mm
20-5331.00	Ø 1,5 mm
20-5337.00	Ø 2,0 mm
20-5343.00	Ø 2,5 mm



20-5327.00	Ø 1,0 mm
20-5333.00	Ø 1,5 mm
20-5339.00	Ø 2,0 mm
20-5345.00	Ø 2,5 mm



20-5246.00



20-5247.00



20-5248.00



20-5249.00



20-5346.00



20-5347.00



20-5348.00



20-5349.00



20

Ohrzangchen
Ear Forceps
Pinces auriculaires
Pinzas auriculares



20-5550.00



20-5551.00



20-5553.00



20-5554.00



20-5555.00



20-5556.00



20-5557.00



20-5559.00

1x2



20-5560.00

1x2



20-5561.00



20-5562.00



20-5563.00



20-5565.00



20-5567.00



20-5586.00



20-5587.00



20-5588.00



20-5589.00



20-5650.00



20-5651.00



20-5653.00



20-5654.00



20-5655.00



20-5657.00



20-5659.00

1x2



20-5660.00



20-5662.00



20-5663.00



20-5665.00



20-5667.00



20-5686.00



20-5687.00



20-5688.00



20-5689.00





SCHUKNECHT

20-6001.01



SCHUKNECHT

20-6001.02



SCHUKNECHT

20-6003.15

15,5 cm, 6"



WULLSTEIN

20-6004.15

15,5 cm, 6"



TABB

20-6005.15

15,5 cm, 6"

Ø 3,5 mm



PLESTER

20-6006.35

15,5 cm, 6"



ROSEN



20-6009.10

1,0 mm



20-6009.14

1,4 mm



20-6009.16

1,6 mm



20-6009.20

2,0 mm



20-6009.26

2,6 mm



20-6009.28

2,8 mm



20-6009.30

3,0 mm

Diagram illustrating the BARBARA otoscope handle with various tip shapes and sizes. The handle is labeled **BARBARA**.

20-6110.15	20-6111.15	25°	0,3 mm	20-6120.03	20-6122.03	20-6124.03
20-6113.15	20-6115.15	45°	0,6 mm	20-6120.06	20-6122.06	20-6124.06
		90°	1,0 mm	20-6120.10	20-6122.10	20-6124.10
			1,2 mm		20-6122.12	20-6124.12
			1,5 mm		20-6122.15	20-6124.15
			2,0 mm		20-6122.20	20-6124.20
			2,5 mm		20-6122.25	20-6124.25

Diagram illustrating the BARBARA, ROSEN, and MC GEE otoscope handles with various tip shapes and sizes. The handles are labeled **BARBARA**, **ROSEN**, and **MC GEE**.

0,5 mm	20-6125.05	20-6136.15	20-6133.05
1,0 mm	20-6125.10	15,5 cm, 6"	20-6133.10
0,5 mm		20-6137.15	20-6135.05
1,0 mm		15,5 cm, 6"	20-6135.10

Diagram illustrating the ROSEN instrument, showing a large vertical view on the left and a grid of smaller tip views on the right. The tip views are arranged in two rows of three, labeled with angles: 90°, 90°, 25°, 25°, 45°, and 45°.

0,3 mm	20-6130.03	20-6132.03	20-6141.03	20-6143.03	20-6145.03	20-6147.03
0,6 mm	20-6130.06	20-6132.06	20-6141.06	20-6143.06	20-6145.06	20-6147.06
1,0 mm	20-6130.10	20-6132.10	20-6141.10	20-6143.10	20-6145.10	20-6147.10

ROSEN

Diagram illustrating the FISCH instrument, showing a large vertical view on the left and four smaller tip views on the right.

20-6151.16 **20-6153.16**

20-6155.16 **20-6157.16**

FISCH

Diagram illustrating the HOUSE instrument, showing a large vertical view on the left and two smaller tip views on the right.

HOUSE

20-6200.01	1,0/1,2 mm
20-6200.02	1,5/1,8 mm

Diagram illustrating the HOUSE instrument, showing a large vertical view on the left and two smaller tip views on the right.

HOUSE

20-6202.01	1,0/1,2 mm
20-6202.02	1,5/1,8 mm

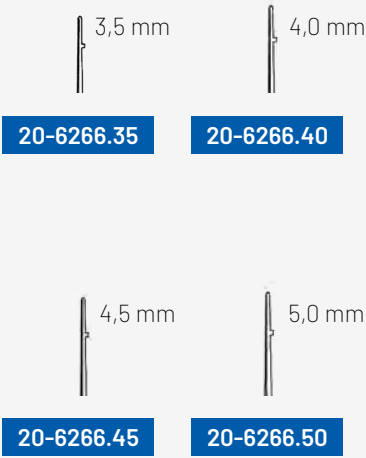

20-6266.35

20-6266.40

20-6266.45

20-6266.50

HOUSE

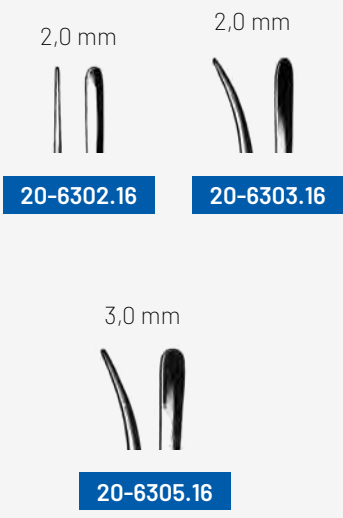

20-6302.16

20-6303.16

20-6305.16

LEMPERT



LEMPERT
 20-6307.20
 20,5 cm, 8"

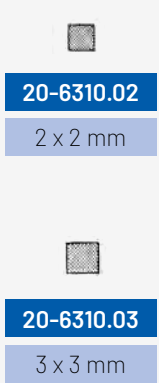

20-6310.02

2 x 2 mm

20-6310.03

3 x 3 mm

PASSOW



MUCK
 20-6312.13
 13 cm, 5"

Chapter 21

Table of Contents

Rhinologie / **p. 342 - 366**

Rhinology / **p. 342 - 366**

Rhinologie / **p. 342 - 366**

Rinología / **p. 342 - 366**



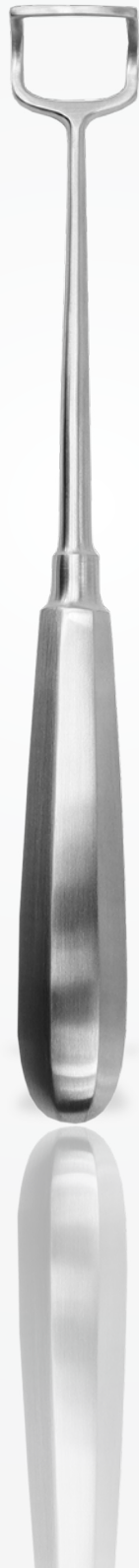



21-6450.01

Fig. 1



21-6450.02

Fig. 2



21-6450.03

Fig. 3



21-6450.04

Fig. 4



21-6460.01

Fig. 1



21-6460.02

Fig. 2



THUDICHUM



21-6450.05

Fig. 5



21-6450.06

Fig. 6

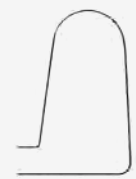

21-6450.07

Fig. 7



VOLTOLINI



21-6460.03

Fig. 3



HARTMANN-HALLE

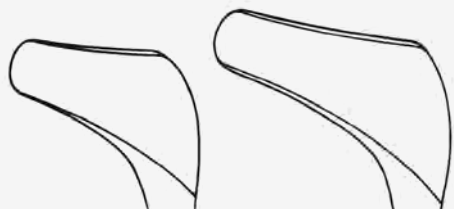

21-6502.01

Fig. 1

21-6502.02

Fig. 2



21-6502.03

Fig. 3



MOD. WIEN

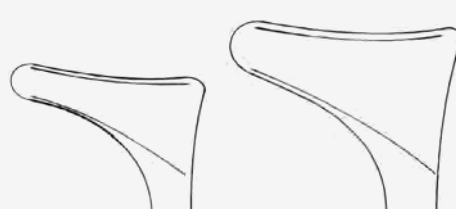

21-6512.01

Fig. 1

21-6512.02

Fig. 2



21-6512.03

Fig. 3



leichtes Modell
 lightweight model
 model léger
 modelo ligero

MOD. WIEN

21-6513.03



TIECK-HALLE

21-6516.13

13,5 cm, 5 1/4"



YANKAUER

21-6531.19

19 cm, 7 1/2"



KILLIAN

13 cm, 5"

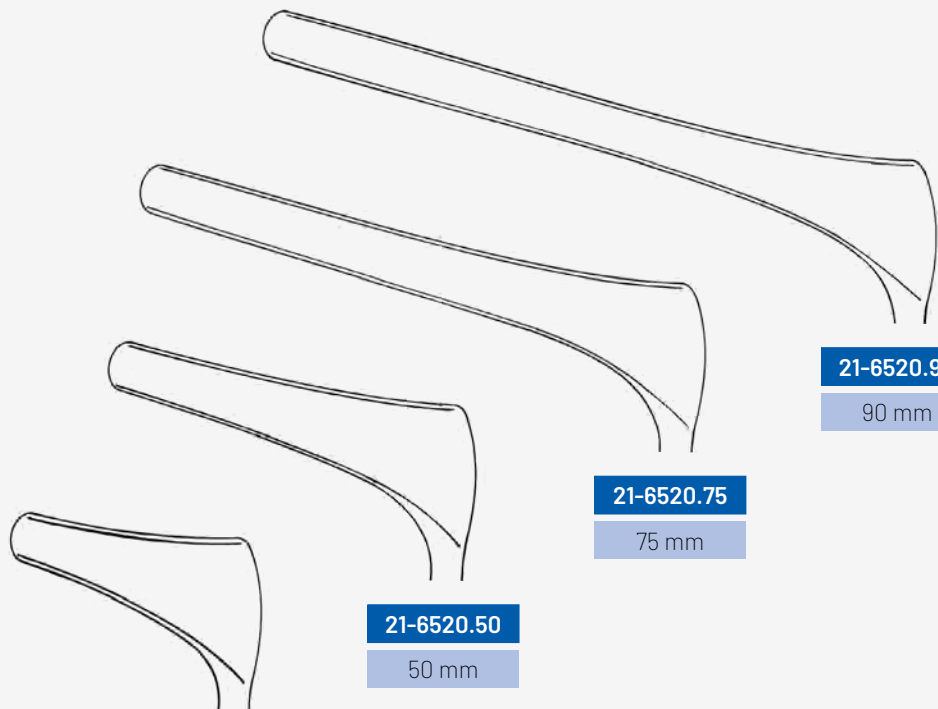

21-6520.90

90 mm

21-6520.75

75 mm

21-6520.50

50 mm

21-6520.35

35 mm



COTTLE

14 cm, 5 1/2"

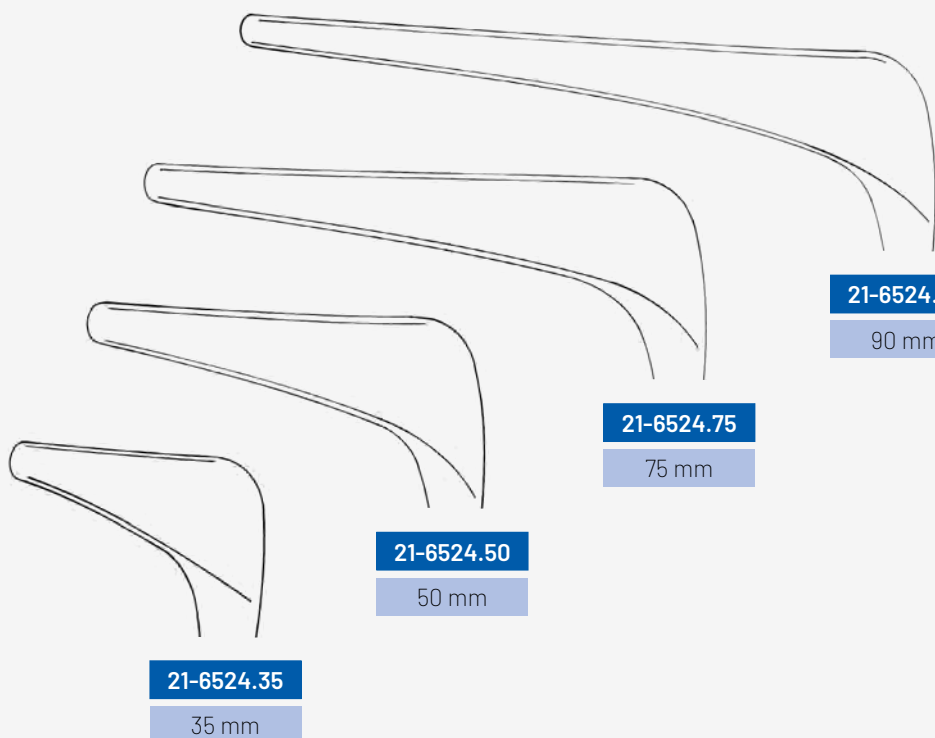

COTTLE

14 cm, 5 1/2"

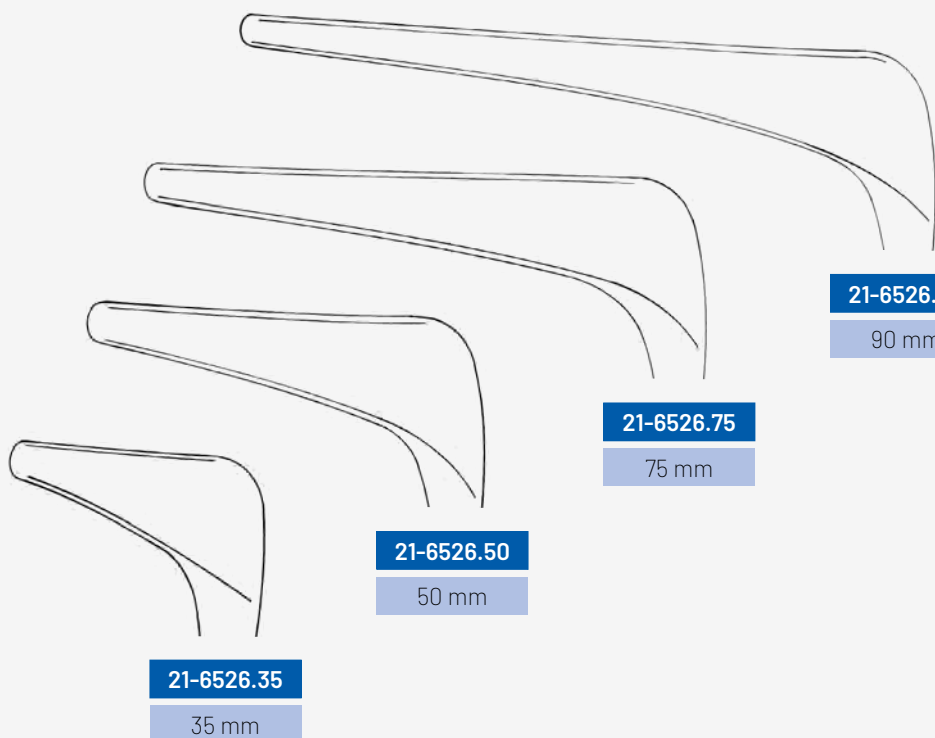



MICHEL



21-6539.12

12 mm



21-6539.14

14 mm



21-6539.16

16 mm



21-6539.18

18 mm



TROELTSCH

21-6551.15

15 cm, 5 3/4"

TROELTSCH

21-6551.18

18 cm, 7"



JANSEN

21-6554.20

20 cm, 8"

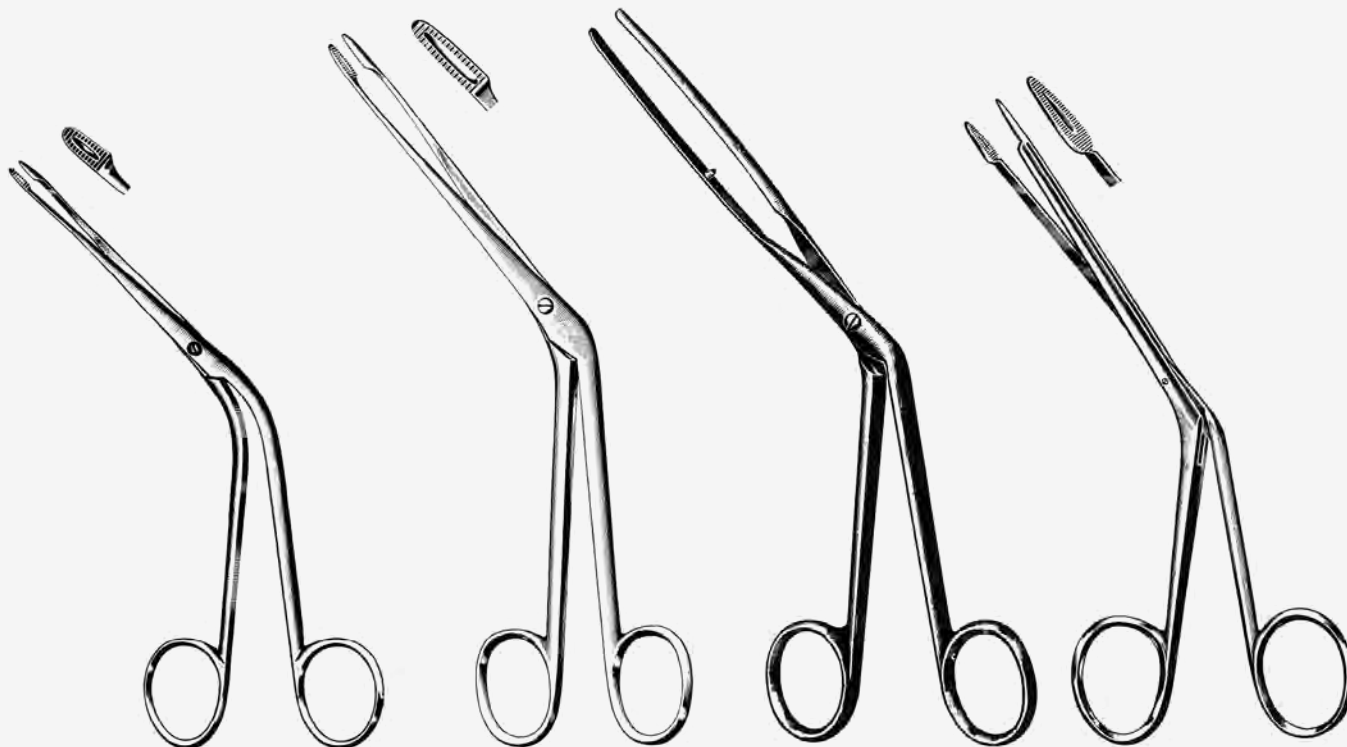

HARTMANN
 21-6561.16
 16 cm, 6 1/4"

HARTMANN
 21-6561.20
 20 cm, 8"

LUBET-BARBON
 21-6565.20
 20 cm, 8"

LITTAUER
 21-6567.18
 18 cm, 7"



HEYMANN-KNIGHT
 21-6569.18
 18 cm, 7"

NOYES
 21-6571.14
 14,5 cm, 5 1/2"

NOYES
 21-6573.14
 14,5 cm, 5 1/2"



21-6581.01
Fig. 1



21-6581.02
Fig. 2



21-6581.03
Fig. 3

HEYMANN
18 cm, 7"

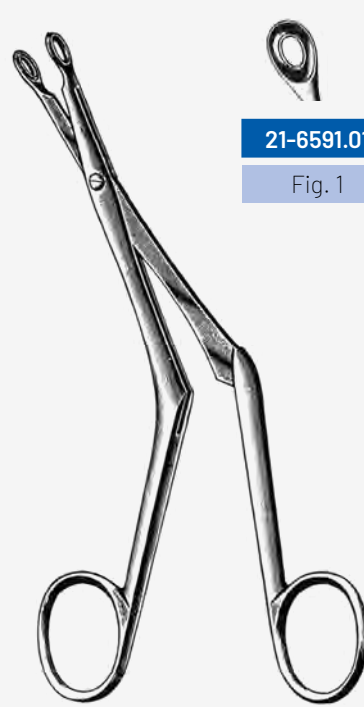

21-6591.01
Fig. 1

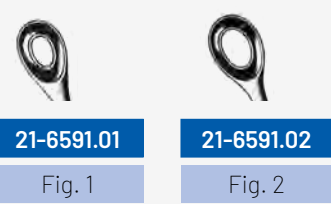

21-6591.02
Fig. 2

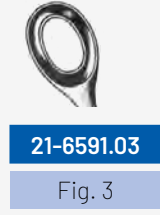

21-6591.03
Fig. 3

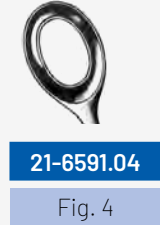

21-6591.04
Fig. 4

BRUENINGS
19 cm, 7 1/2"



KNIGHT
21-6585.18
18 cm, 7"



LUC
19 cm, 7 1/2"

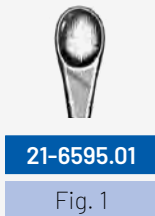

21-6595.01
Fig. 1

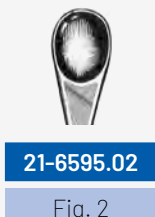

21-6595.02
Fig. 2

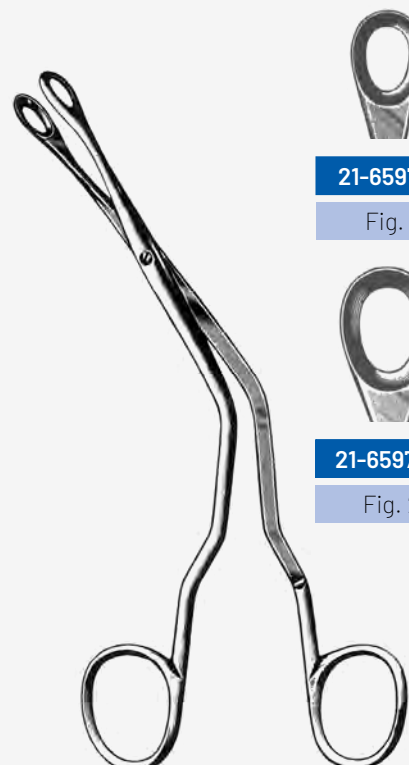

21-6597.01
Fig. 1

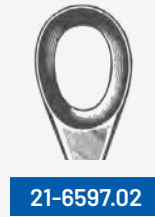

21-6597.02
Fig. 2

LUC
19 cm, 7 1/2"

21

Scharfe Nasenzangen
Nasal Cutting Forceps
 Pinces coupantes nasaux
 Pinzas cortantes nasales

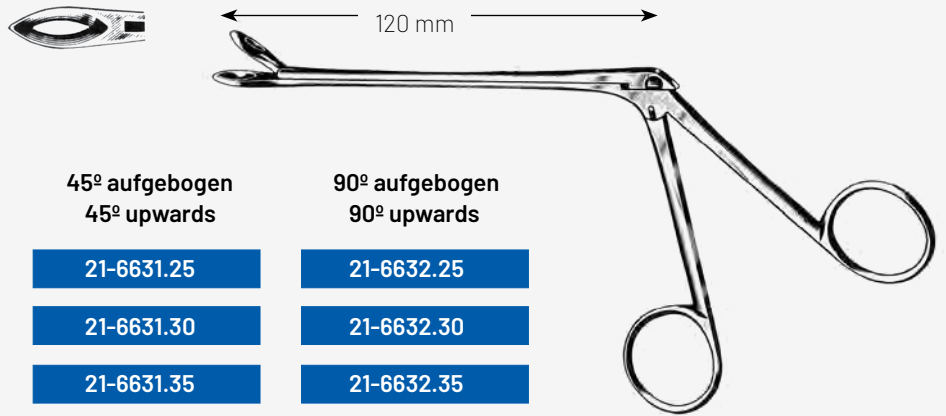

Maullänge Jaw	gerade straight	45° aufgebogen 45° upwards	90° aufgebogen 90° upwards
2,5 mm	21-6630.25	21-6631.25	21-6632.25
3,0 mm	21-6630.30	21-6631.30	21-6632.30
3,5 mm	21-6630.35	21-6631.35	21-6632.35
4,0 mm	21-6630.40	21-6631.40	21-6632.40
5,0 mm	21-6630.50	21-6631.50	21-6632.40
6,0 mm	21-6630.60		

BLAKESLEY

STRUYCKEN
 21-6631.01
 Fig. 1

STRUYCKEN
 21-6631.02
 Fig. 2

MYLES
 21-6637.05
 5,0 mm

MYLES
 21-6637.07
 7,0 mm

MYLES
 21-6637.09
 9,0 mm

HARTMANN
 21-6635.05
 5,0 mm

HARTMANN
 21-6635.07
 7,0 mm

HARTMANN
 21-6635.09
 9,0 mm

HARTMANN
 21-6635.11
 11,0 mm





Septum-Quetschzange
 Septum Crushing Forceps
 Pince à écraser la cloison
 Pinza para magullar tabique

RUBIN
 21-6651.21
 21 cm, 8 1/4"



HAJEK-CLAUS
 21-6720.20
 20 cm, 8"



21-6703.03 3 x 3 mm
 21-6703.04 4 x 4 mm
 21-6703.05 5 x 5 mm
 21-6703.06 6 x 6 mm

KERRISON
 9 cm, 3 1/2"

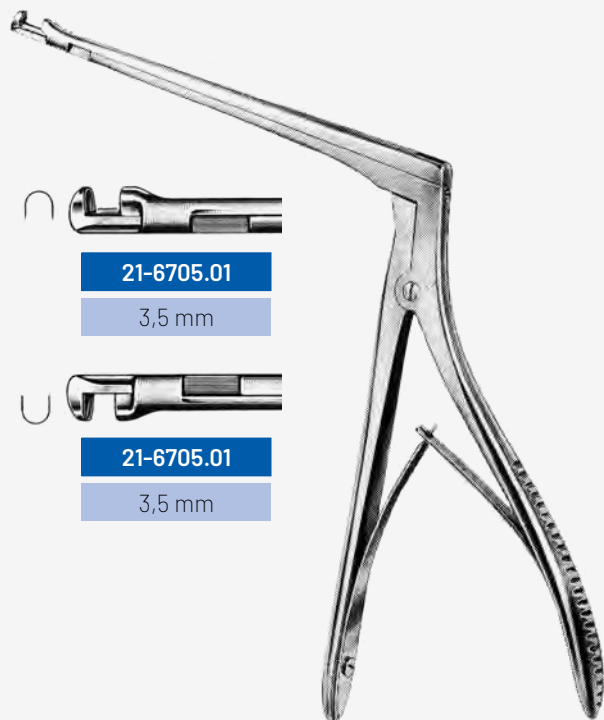

21-6705.01
 3,5 mm

21-6705.01
 3,5 mm

HAJEK-KOFLER



21-6711.10	1,0 mm
21-6711.25	2,5 mm
21-6711.40	4,0 mm

CITELLI



BEYER
 21-6715.20



MIDDLETON-JANSEN
 21-6723.19
 19 cm, 7 1/2"



MIDDLETON-JANSEN
 21-6725.19
 19 cm, 7 1/2"



21-6740.15	Ø 1,5 mm
21-6740.18	Ø 1,8 mm
21-6740.20	Ø 2,0 mm

LICHTWITZ
 10 cm, 4"



KILLIAN
 21-6741.03
 14 cm, 5 1/2"



KRAUSE
 21-6751.26
 26 cm, 10 1/4"

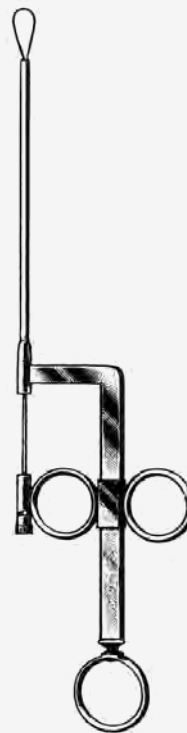

WILDE
 21-6752.24
 24 cm, 9 1/2"



21-6755.03
 Dtzd. /doz. / douz / doc.

21

Nasenmesser
Nasal Knives
 Bistouris nasaux
 Bisturries nasales



JOSEPH



spitz
pointed
pointu
agudo

21-6772.16



21-6773.16



stumpf
blunt
mousse
romo

21-6770.16



21-6771.16



FREER

21-6774.15

15 cm, 5 3/4"



FREER

21-6775.19

19 cm, 7 1/2"



JOSEPH

21-6776.16

16 cm, 6 1/4"



CONVERSE

21-6779.16

16 cm, 6 1/4"



COTTLE

21-6780.15

15 cm, 5 3/4"



COTTLE
 21-6782.15
 15 cm, 5 3/4"



COTTLE
 21-6784.15
 15 cm, 5 3/4"



COTTLE
 21-6785.15
 15 cm, 5 3/4"



BRUENINGS
 21-6798.16
 16,5 cm, 6 1/2"



BALLENGER
 20 cm, 8"



21-6790.03
 3,0 mm



21-6790.04
 4,0 mm



21-6790.05
 5,0 mm



BALLENGER
 20 cm, 8"



21-6792.03
 3,0 mm



21-6792.04
 4,0 mm



21-6792.05
 5,0 mm

21

Septum-Elevatorien
Septum Elevators
Elévateurs pour la cloison de nez
Elevadores para tabique nasal



MC KENTY

15 cm, 5 3/4"

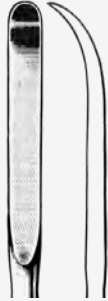

21-6810.04

4,0 mm

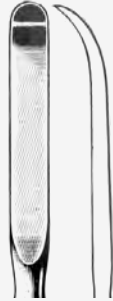

21-6810.05

5,0 mm

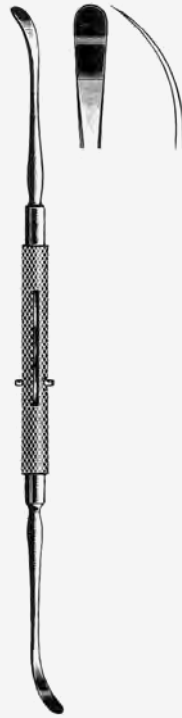

ROGER

21-6813.19

19 cm, 7 1/2"



FREER

21-6815.18

18 cm, 7"



FREER

21-6817.19

19 cm, 7 1/2"

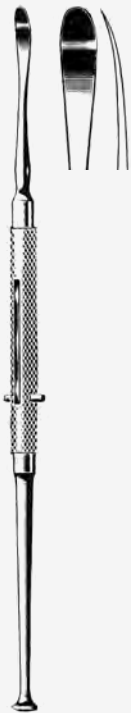

FREER

21-6819.19

19 cm, 7 1/2"



COTTLE

21-6821.23

23 cm, 9"



COTTLE

21-6823.22

22 cm, 8 1/2"



KILLIAN

21-6826.22

22 cm, 8 1/2"



JOSEPH
 21-6825.16
 16 cm, 6 1/4"



COTTLE
 21-6825.19
 19 cm, 7 1/2"



HAJEK-BALLENGER
 21-6828.21
 22 cm, 8 1/2"



BALLENGER
 21-6830.22
 22 cm, 8 1/2"



FREER
 21-6850.04



FREER
 21-6851.04



21-6854.04	4 mm
21-6854.07	7 mm
21-6854.09	9 mm
21-6854.12	12 mm

COTTLE
 18 cm, 7"



COTTLE
 21-6855.06
 18 cm, 7"

21

Nasenplastik-Meißel
Rhinoplastic Chisels
 Ciseaux-burins pour la plastique de nez
 Cinceles para la plástica nasal



21-6858.04	4 mm
21-6858.07	7 mm
21-6858.09	9 mm
21-6858.12	12 mm

COTTLE



21-6860.04	4 mm
21-6860.07	7 mm
21-6860.12	12 mm

COTTLE

18 cm, 7"



21-6870.04	4 mm
21-6870.05	5 mm
21-6870.06	6 mm
21-6870.07	7 mm

FOMON

17 cm, 6 3/4"

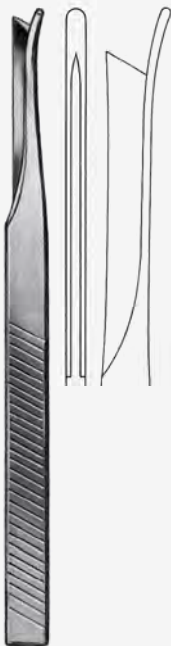

SILVER
 21-6873.01
 18 cm, 7"

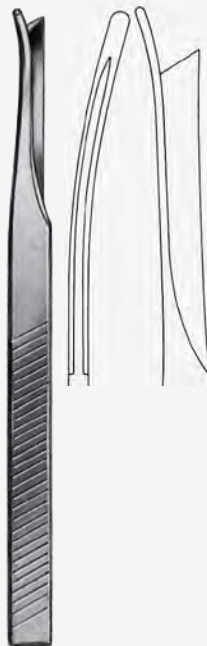

SILVER
 21-6873.02
 18 cm, 7"



SILVER
 21-6873.03
 18 cm, 7"



21-6872.10	10 mm
21-6872.12	12 mm
21-6872.14	14 mm
21-6872.16	16 mm

CINELLI
 17 cm, 6 3/4"



21-6884.04	4 mm
21-6884.06	6 mm
21-6884.08	8 mm

BALLENGER
 15 cm, 6"



KILLIAN-CLAUS
 21-6882.05
 17 cm, 6 3/4"



WEST
 21-6886.16
 16 cm, 6 1/4"



WEST
 21-6887.16
 16 cm, 6 1/4"



6 mm

FREER
 21-6889.16
 16 cm, 6 1/4"

21

Nasenraspeln
Nasal Rasps
Râpes nasaux
Raspas nasales

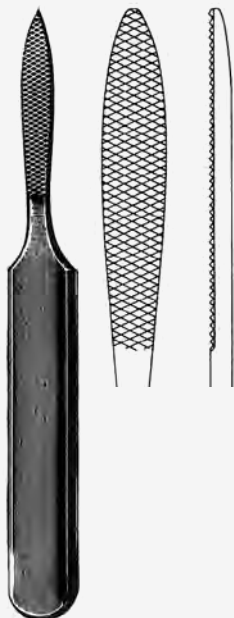

JOSEPH

21-6902.16

16 cm, 6 1/4"

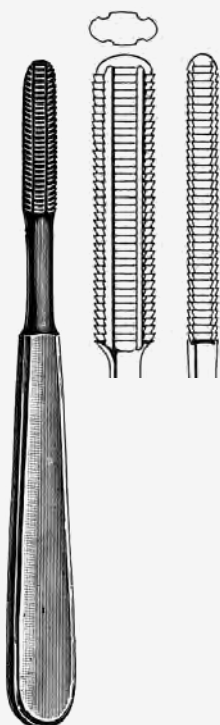

AUFRICHT

21-6904.18

18 cm, 7"



LEWIS

18 cm, 7"



21-6907.18



21-6907.19



WIENER

21 cm, 8 1/4"



21-6911.21

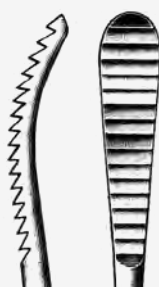

21-6913.21



JOSEPH

18 cm, 7"



21-6914.16



21-6916.16

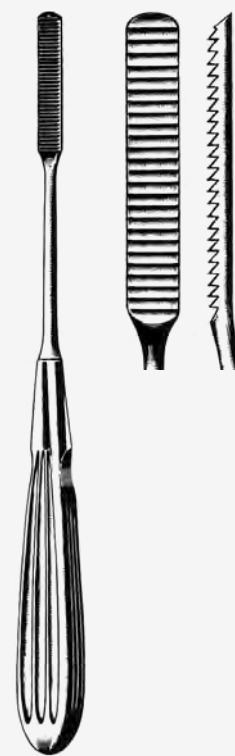

MALTZ (COTTLE)

21-6918.21

21 cm, 8 1/4"

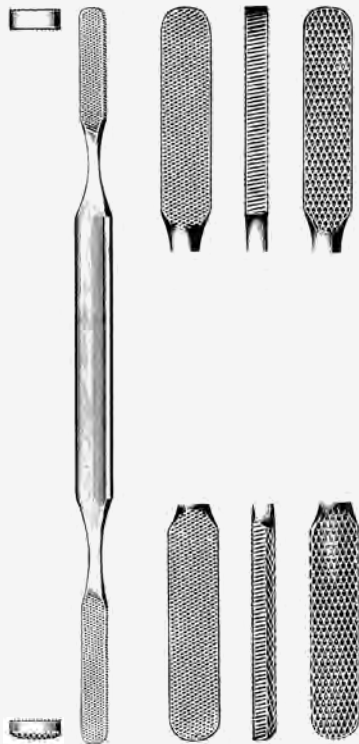

FOMON
 21-6920.21
 21 cm, 8 1/4"



GALLAHER

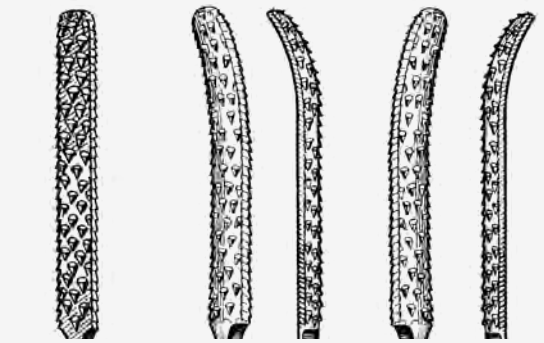

21-6926.16 Fig. 1
 21-6927.16 Fig. 2
 21-6929.16 Fig. 3



FOMON
 20 cm, 8"

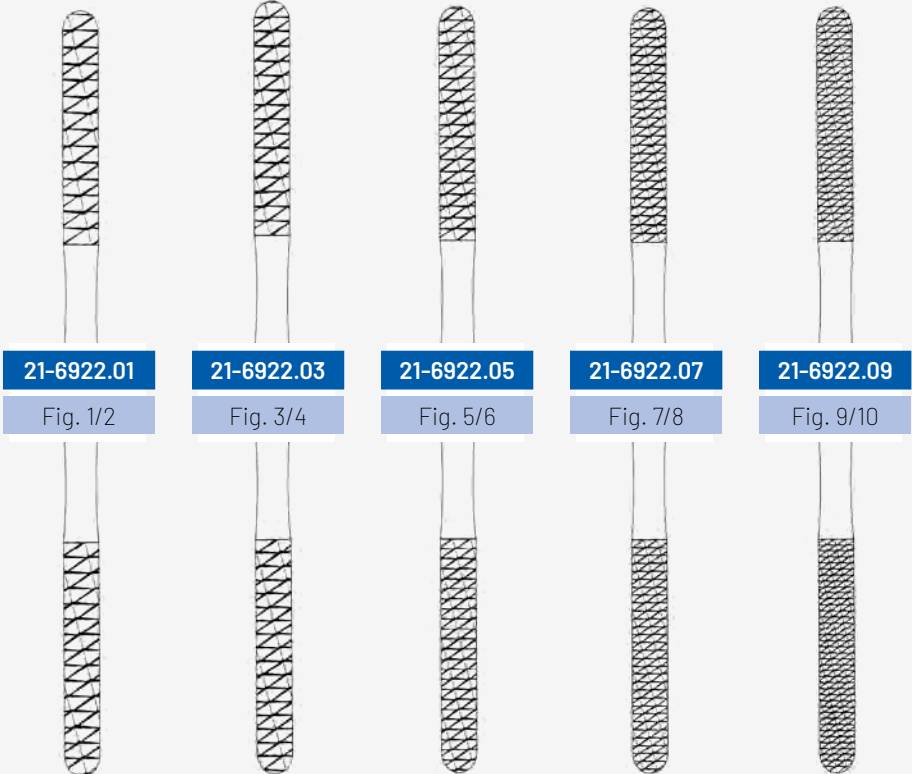

21-6922.01 Fig. 1/2
 21-6922.03 Fig. 3/4
 21-6922.05 Fig. 5/6
 21-6922.07 Fig. 7/8
 21-6922.09 Fig. 9/10



21-6932.19

JOSEPH

19 cm, 7 1/2"

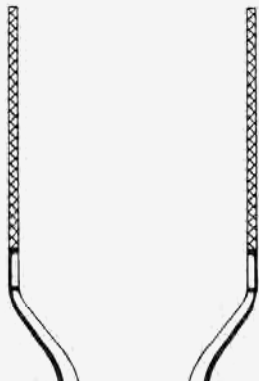

21-6934.19

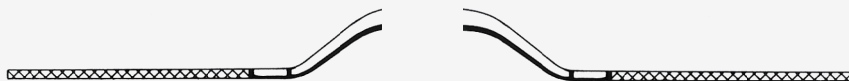

JOSEPH

21-6935.01

17 cm, 6 3/4"

JOSEPH

21-6935.02

17 cm, 6 3/4"



COTTLE

21-6956.14

14 cm, 5 1/2"



FOMON

21-6956.16

16 cm, 6 1/4"



FOMON

21-6957.17

17 cm, 6 3/4"



COTTLE-NEIVERT

21-6959.20

20 cm, 8"



21-6960.18

Fig. 1

21-6962.18

Fig. 2

GILLIES

18 cm, 7"

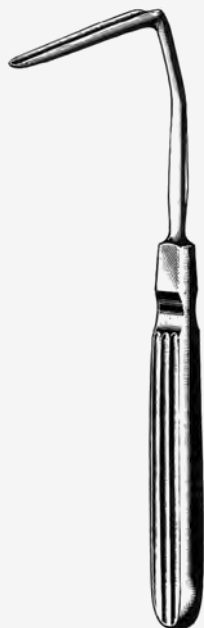

AUFRICHT

21-6951.16

16 cm, 6 1/4"



JATHO

21-6995.15

15 cm, 5 3/4"



ASCH

21-6971.23

23 cm, 9"



WALSHAM

23 cm, 9"



21-6972.23



21-6973.23



21-6975.23



FAULKNER

21-7001.21

21 cm, 8 1/4"



COAKLEY

17 cm, 6 3/4"



21-7007.01

Fig. 1



21-7007.02

Fig. 2



21-7007.03

Fig. 3



21-7007.04

Fig. 4



21-7007.05

Fig. 5



21-7007.06

Fig. 6



BECKMANN

22 cm, 8 1/2"



21-7020.01

Fig. 1



21-7020.02

Fig. 2



21-7020.03

Fig. 3



21-7020.04

Fig. 4



21-7020.05

Fig. 5



21-7020.06

Fig. 6



BARNHILL
21 cm, 8 1/4"



21-7030.01
Fig. 1



21-7030.02
Fig. 2



21-7030.03
Fig. 3



21-7030.04
Fig. 4



ST. CLAIR-THOMSON
21 cm, 8 1/4"



21-7036.01
Fig. 1



21-7036.02
Fig. 2



21-7036.03
Fig. 3



21-7036.04
Fig. 4

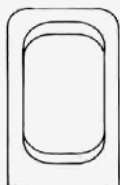

21-7041.01

Fig. 1

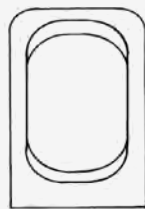

21-7041.02

Fig. 2

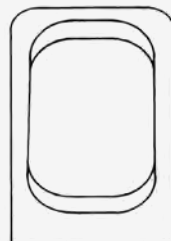

21-7041.03

Fig. 3

mit ungelochter Klinge
 with unperforated blade
 à lame non-perforée
 con hoja no perforada

LA FORCE

25 cm, 10"

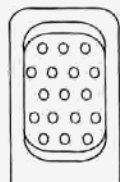

21-7042.01

Fig. 1

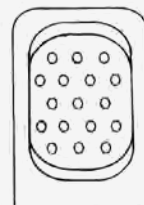

21-7042.02

Fig. 2

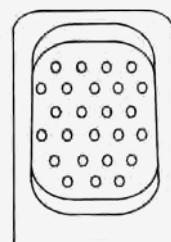

21-7042.03

Fig. 3

Ersatzklingen, gelocht
 Spare Blades, perforated
 Lames de rechange perforées
 Hojas de repuesto, perforadas

Chapter 22

Table of Contents

Mund und Zunge / **p. 368 - 375**

Mouth and Tongue / **p. 368 - 375**

Bouche et langue / **p. 368 - 375**

Boca y lengua / **p. 368 - 375**





22

Zungenspatel, Lippenhalter
Tongue Depressors, Lip Retractors
 Abaisse-langues, écarteurs des lèvres
 Abajalenguas, Separadores de labios



22-7502.16

16 cm, 6 1/4"



FRENZEL

22-7505.16

16,5 cm, 6 1/2"



BRUENINGS

22-7507.19

19 cm, 7 1/2"



BUCHWALD

22-7509.19

19 cm, 7 1/2"

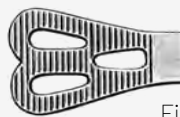

Fig. 1

22-7515.01

14 cm, 5 1/2"

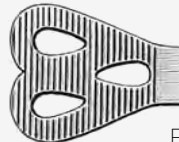

Fig. 2

22-7515.02

15 cm, 5 3/4"



HARTMANN

22-7511.15

15 cm, 5 3/4"



WIEDER

14 cm, 5 1/2"



ANDREW

22-7517.11

11 cm, 4 1/4"



TOBOLD

22-7519.14

14,5 cm, 5 1/2"



STERNBERG

22-7527.14 14 cm, 5 1/2"

22-7527.16 16 cm, 6 1/4"

22-7527.18 18 cm, 7"



STERNBERG

22-7529.12 12 cm, 4 3/4"

22-7529.14 14 cm, 5 1/2"

22-7529.16 16 cm, 6 1/4"



22-7530.11

11 cm, 4 1/4"



22-7535.19

19 cm, 7 1/2"



COLLIN

22-7550.16 16 cm, 6 1/4"

22-7550.18 18 cm, 7"

Zungenzangen
 Tongue Holding Forceps
 Pincas tire-langues
 Pinzas tiralenguas



YOUNG

22-7555.16

16 cm, 6 1/4"



22-7555.99

Ersatz (Paar)
 Spare (Pair)
 Rechange (paire)
 Repuesto (pareja)

22

Mundsperrer
Mouth Gags
 Ouvre-bouches
 Abreboocas



DOYEN-JANSEN (MOLT)

22-7565.12

12 cm, 4 3/4"

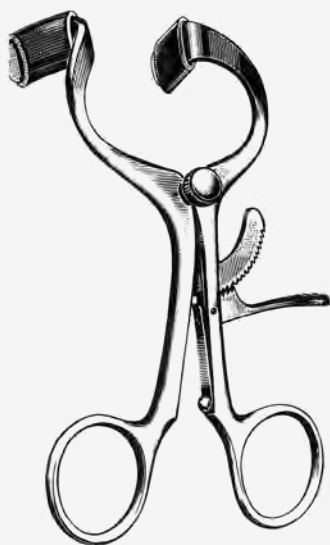

DOYEN-JANSEN (MOLT)

22-7565.14

14 cm, 5 1/2"



DENHART

22-7567.12

12 cm, 4 3/4"



HEISTER

22-7572.13

13 cm, 5"

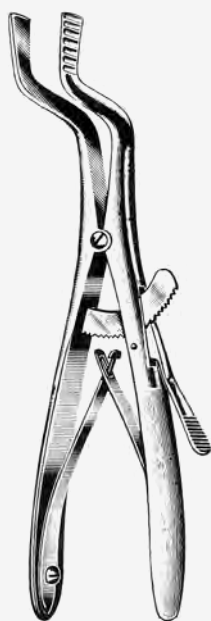

ROSER-KOENIG

22-7570.16

16 cm, 6 1/4"

22-7570.19

19 cm, 7 1/2"

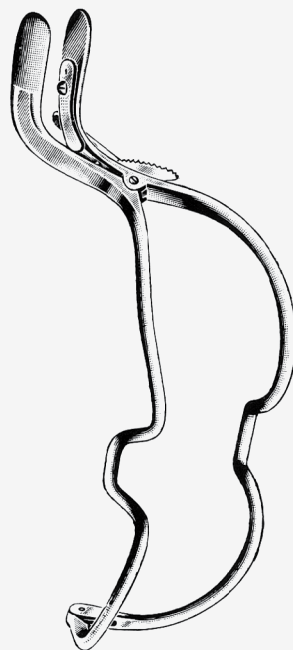

JENNINGS

22-7574.09

9 cm, 3 1/4"

22-7574.11

11 cm, 4 1/4"

22-7574.13

13 cm, 5"

22-7574.15

15 cm, 5 3/4"



SEEMANN-SEIFFERT

22-7585.09

9 cm, 3 1/4"

22-7585.11

11 cm, 4 1/4"

22-7585.13

13 cm, 5"

22-7585.15

15 cm, 5 3/4"

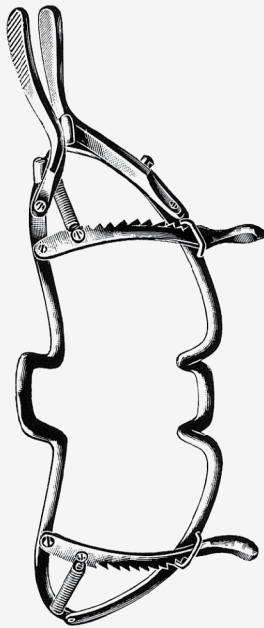

WHITEHEAD

22-7580.11	11 cm, 4 1/4"
22-7580.13	13 cm, 5"
22-7580.15	15 cm, 5 3/4"



WHITEHEAD

22-7581.11	11 cm, 4 1/4"
22-7581.13	13 cm, 5"
22-7581.15	15 cm, 5 3/4"

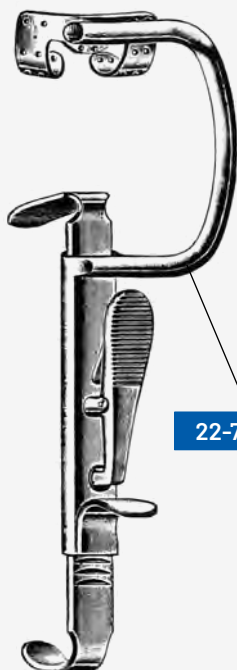

22-7610.10

DAVIS-BOYLE

22-7610.00

Set



27 x 105 mm

22-7610.01

Fig. 1



25 x 90 mm

22-7610.02

Fig. 2



25 x 75 mm

22-7610.03

Fig. 3



22 x 60 mm

22-7610.04

Fig. 4



20 x 25 mm

22-7610.05

Fig. 5

22

Mundsperrer
Mouth Gags
Ouvre-bouches
Abrebocas

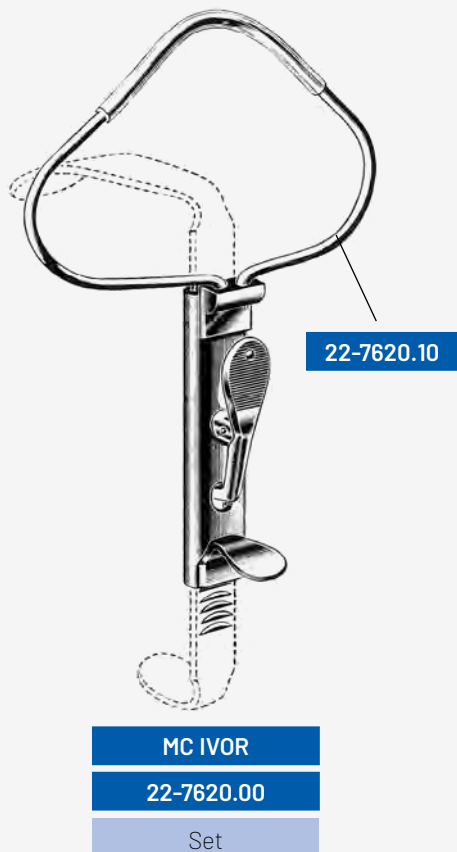

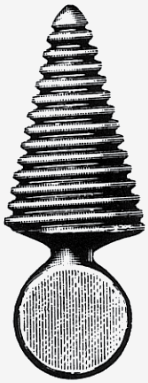

MAUNDER

22-7660.10

10 cm, 4 1/2"



PITHA

22-7665.10

10 cm, 4 1/2"



LANGENBECK

22-7671.01

Fig. 1



LANGENBECK

22-7671.02

Fig. 2



LANGENBECK

22-7671.03

Fig. 3



ROWE

22,5 cm, 8 3/4"
 Säuglinge / Infants / nourrissons / recién nacidos

23,5 cm, 9"
 Kinder / Children / enfants / niños

24 cm, 9 1/2"
 Erwachsene / Adults / adultes / adultos

links
 left side
 côté gauche
 izquierda

22-7701.22 22,5 cm, 8 3/4"

22-7701.23 23,5 cm, 9"

22-7701.24 24 cm, 9 1/2"



ROWE

rechts
 right side
 côté droit
 derecha

22-7703.22 22,5 cm, 8 3/4"

22-7703.23 23,5 cm, 9"

22-7703.24 24 cm, 9 1/2"

Chapter 23

Table of Contents

Tonsillen / **p. 376 - 382**

Tonsilectomy / **p. 376 - 382**

Amygdales / **p. 376 - 382**

Amígdalas / **p. 376 - 382**





23

Tonsillen
Tonsils
 Amygdales
 Amígdalas



LOVE

23-7803.18 19 mm

23-7803.20 20 mm

23-7803.22 22 mm



HOFER

23-7809.24

24 cm, 9 1/2"



NAGER

23-7811.23

23 cm, 9"

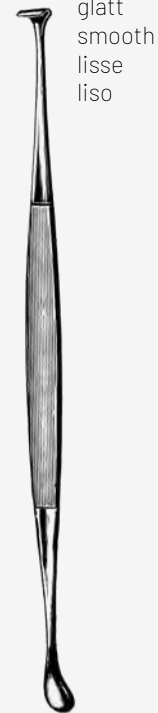

glatt
 smooth
 lisse
 liso

HURD

23-7831.22

22 cm, 8 1/2"

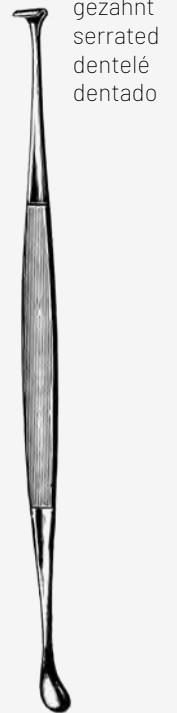

gezahnt
 serrated
 dentelé
 dentado

HURD

23-7833.22

22 cm, 8 1/2"



HENKE

23-7835.23

23 cm, 9"

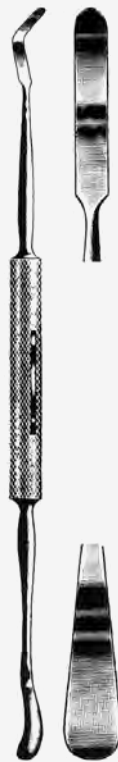

CARPENTER

23-7839.25

25 cm, 10"



CARPENTER

23-7843.24

24 cm, 9 1/2"

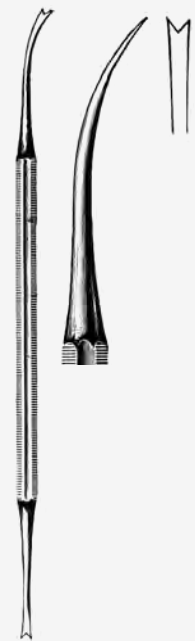

LUNIATSCHEK

23-7851.19

19 cm, 7 1/2"



DUPUY-WEISS

23-7865.22

22 cm, 8 1/2"



DUPUY-WEISS

23-7867.22

22 cm, 8 1/2"



SAWTEL

23-7881.19

19 cm, 7 1/2"



SAWTEL

23-7885.19

19 cm, 7 1/2"

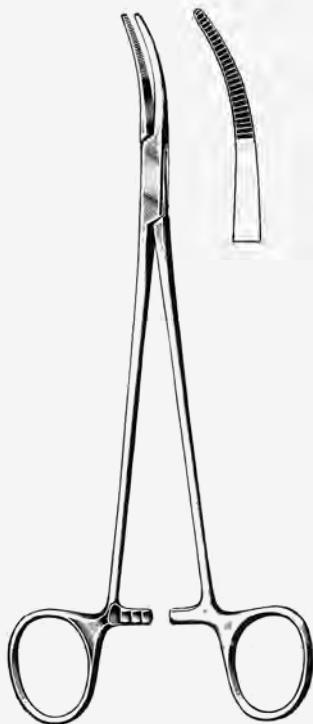

SCHNIDT

23-7883.19

19 cm, 7 1/2"

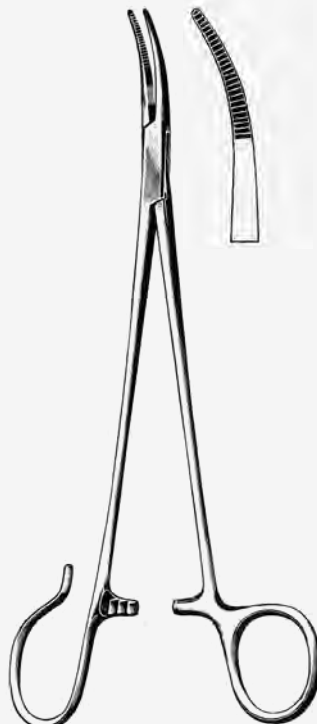

SCHNIDT

23-7887.19

19 cm, 7 1/2"



NEGUS



23-7891.19

19 cm, 7 1/2"

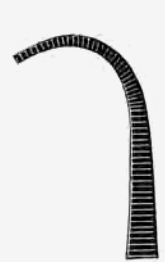

23-7893.19

19 cm, 7 1/2"

23

Tonsillen
Tonsils
 Amygdales
 Amígdalas



23-7902.19
 19 cm, 7 1/2"

23-7903.19
 19 cm, 7 1/2"

COLVER



WHITE

23-7905.18 18 cm, 7"
23-7905.23 23 cm, 9"



BALLENGER

23-7907.21
 21,5 cm, 8 1/4"



BLOHMKE
23-7909.20
 20 cm, 8"



TYDING
23-7911.21
 21 cm, 8 1/4"

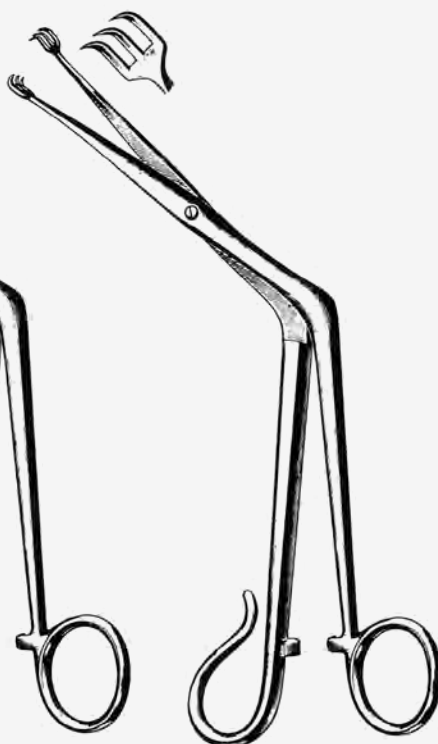

TIVNEN
23-7913.21
 21 cm, 8 1/4"



MARSHIK
23-7919.22
 22 cm, 8 1/2"



CORWIN

23-7931.14

14 cm, 5 1/2"



EVES

23-7950.28

28 cm, 11"



EVES

23-7952.28

28 cm, 11"



BRUENINGS

23-7956.28

28 cm, 11"

in Packungen zu 100 Stück
 in packages of 100 pieces
 en paquets de 100 pièces
 en paquetes de 100 piezas

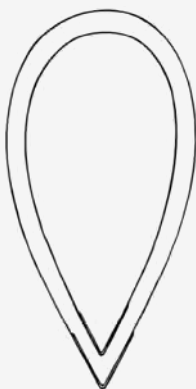

23-7957.40

40 mm

23-7957.50

50 mm

in Packungen zu 12 Stück
 in packages of 12 pieces
 en paquets de 12 pièces
 en paquetes de 12 piezas



23-7959.03

Ø 0,3 mm

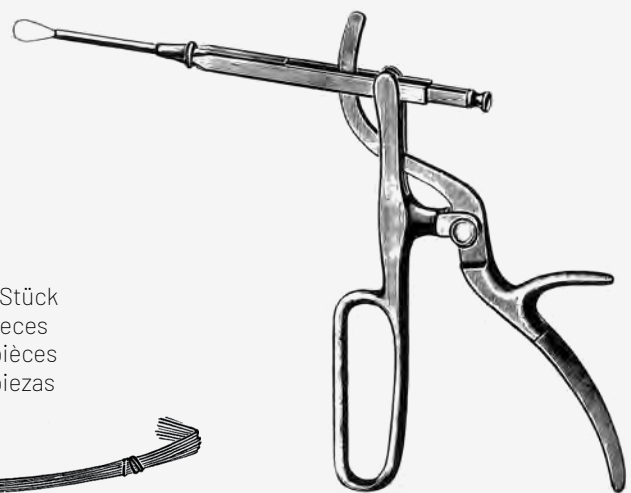

TYDING

23-7960.00



mit 3 Aufsätzen
 with 3 blades
 avec 3 lames
 con 3 hojas

SLUDER-BALLENGER

23-7970.00

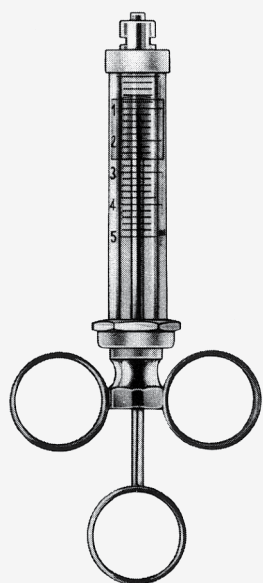

23-7990.02

2 ml

23-7990.05

5 ml

23-7990.10

10 ml



23-7993.00

0°



23-7993.45

45°



23-7993.90

90°

Chapter 24

Table of Contents

Kehlkopf / **p. 384 - 388**

Larynx / **p. 384 - 388**

Larynx / **p. 384 - 388**

Laringe / **p. 384 - 388**







JACKSON
 22 cm, 8 1/2"



24-8001-22
 22 cm, 8 1/2"



24-8003-22
 22 cm, 8 1/2"



FRAENKEL
 24-8011.18
 18 cm, 7"



REICHERT
 24-8021.24
 24 cm, 9 1/2"



24-8015.01
 Fig. 1



24-8015.02
 Fig. 2



24-8015.03
 Fig. 3



24-8015.04
 Fig. 4

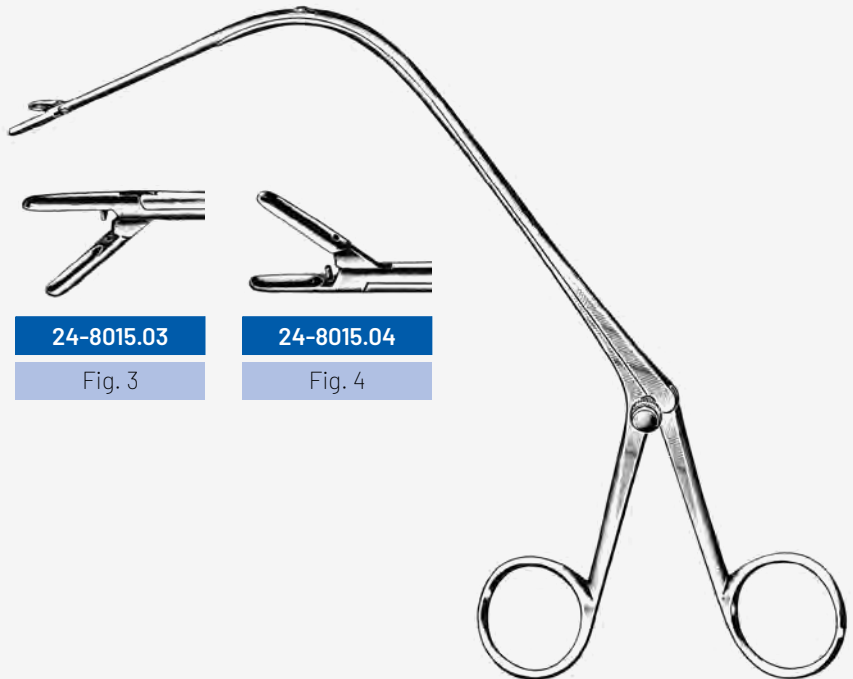

JURASZ
 18 cm, 7"

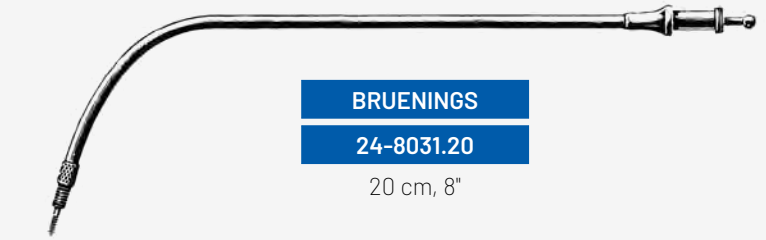

BRUENINGS
 24-8031.20

20 cm, 8"



BRUENINGS

24-8032.20	20 cm, 8"
24-8032.30	30 cm, 12"
24-8032.40	40 cm, 16"
24-8032.50	50 cm, 20"
24-8032.60	60 cm, 24"



HUBER
 24-8030.00



FRAENKEL
 24-8050.00



SEIFFERT
 24-8052.00



FRAENKEL
 24-8054.00



SCHEINMANN
 24-8055.00



SCHEINMANN
 24-8057.00



BRUENINGS
 24-8058.02
 24-8058.03



BRUENINGS
 24-8060.02
 24-8060.03



LANGE
 24-8062.00



KRAUSE
 24-8064.01
 24-8064.02



KRAUSE
 24-8066.00



CORDES
 24-8068.01
 24-8068.02
 24-8068.03
 24-8068.04



SCHUMACHER
 24-8070.00



CORDES
 24-8072.01
 24-8072.02



CORDES
 24-8074.00



ROSENBERG
 24-8076.00

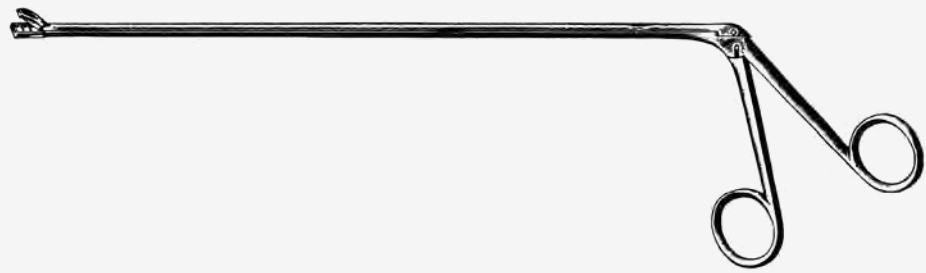

CHEVALIER-JACKSON



Fig. 1



Fig. 2



Fig. 3



Fig. 4



Fig. 5



Fig. 6



Fig. 7

30 cm, 12"	24-8130.01	24-8130.02	24-8130.03	24-8130.04	24-8130.05	24-8130.06	24-8130.07
40 cm, 16"	24-8140.01	24-8140.02	24-8140.03	24-8140.04	24-8140.05	24-8140.06	24-8140.07
50 cm, 20"	24-8150.01	24-8150.02	24-8150.03	24-8150.04	24-8150.05	24-8150.06	24-8150.07
60 cm, 24"	24-8160.01	24-8160.02	24-8160.03	24-8160.04	24-8160.05	24-8160.06	24-8160.07



24-8170.08	Fig. 00	8 mm
24-8170.10	Fig. 0	10 mm
24-8170.12	Fig. 1	12 mm
24-8170.14	Fig. 2	14 mm
24-8170.16	Fig. 3	16 mm
24-8170.18	Fig. 4	18 mm
24-8170.20	Fig. 5	20 mm
24-8170.22	Fig. 6	22 mm
24-8170.24	Fig. 7	24 mm
24-8170.26	Fig. 8	26 mm
24-8170.28	Fig. 9	28 mm
24-8170.30	Fig. 10	10 mm



24-8172.08	Fig. 00	8 mm
24-8172.10	Fig. 0	10 mm
24-8172.12	Fig. 1	12 mm
24-8172.14	Fig. 2	14 mm
24-8172.16	Fig. 3	16 mm
24-8172.18	Fig. 4	18 mm
24-8172.20	Fig. 5	20 mm
24-8172.22	Fig. 6	22 mm
24-8172.24	Fig. 7	24 mm
24-8172.26	Fig. 8	26 mm
24-8172.28	Fig. 9	28 mm
24-8172.30	Fig. 10	10 mm



24-8174.12



24-8176.10

Chapter 25

Table of Contents

Gastroskopie / **p. 390 - 394**

Gastroskopy / **p. 390 - 394**

Gastroscoپی / **p. 390 - 394**

Gastroscoپی / **p. 390 - 394**







Ø 1,8 mm	160 cm	25-1110.16	25-1111.16	25-1112.16	25-1113.16
	230 cm	25-1110.23	25-1111.23	25-1112.23	25-1113.23



Ø 2,2 mm	160 cm	25-1120.16	25-1121.16	25-1122.16	25-1123.16
	230 cm	25-1120.23	25-1121.23	25-1122.23	25-1123.23



Ø 2,6 mm	160 cm	25-1130.16	25-1131.16
	230 cm	25-1130.23	25-1131.23



Ø 3,4 mm	160 cm	25-1140.16	25-1141.16	25-1142.16	25-1143.16
	230 cm	25-1140.23	25-1141.23	25-1142.23	25-1143.23



Ø 1,8 mm	160 cm	25-1110.26	25-1111.26	25-1112.26	25-1113.26
	230 cm	25-1110.33	25-1111.33	25-1112.33	25-1113.33



Ø 2,2 mm	160 cm	25-1120.26	25-1121.26	25-1122.26	25-1123.26
	230 cm	25-1120.33	25-1121.33	25-1122.33	25-1123.33



∅ 1,8 mm	160 cm	25-1216.16
	230 cm	25-1216.23



∅ 2,2 mm	160 cm	25-1222.16
	230 cm	25-1222.23



∅ 2,6 mm	160 cm	25-1232.16
	230 cm	25-1232.23



∅ 3,4 mm	160 cm	25-1242.16
	230 cm	25-1242.23



Ø 1,8 mm	160 cm
	230 cm

25-1301.16
25-1301.23

25-1302.16
25-1302.23

25-1304.16
25-1304.23

25-1311.16
25-1311.23



Ø 1,8 mm	160 cm
	230 cm

25-1312.16
25-1312.23

25-1313.16
25-1313.23

25-1314.16
25-1314.23

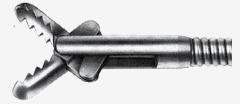
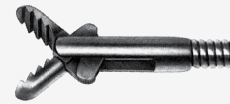
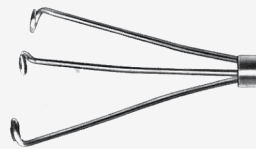

Ø 2,2 mm	160 cm
	230 cm

25-1291.16
25-1291.23

25-1292.16
25-1292.23

25-1341.16
25-1341.23

25-1342.16
25-1342.23

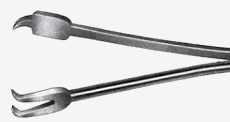
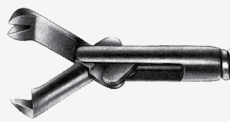
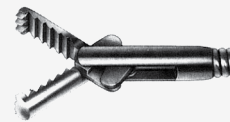

Ø 2,2 mm	160 cm
	230 cm

25-1343.16
25-1343.23

25-1344.16
25-1344.23

25-1351.16
25-1351.23

25-1352.16
25-1352.23

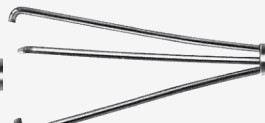

Ø 2,2 mm	160 cm
	230 cm

25-1353.16
25-1353.23

25-1354.16
25-1354.23

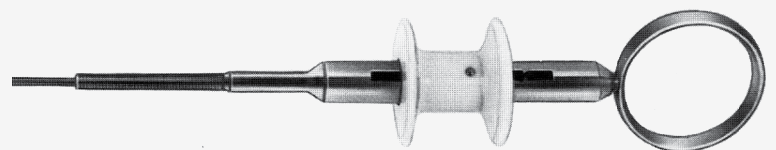

Ø 1,8 mm	160 cm
	230 cm

25-1301.26
25-1301.33

25-1302.26
25-1302.33

Chapter 26

Table of Contents

- Tracheotomie, Kropf / **p. 396 - 400**
- Tracheostomy, Goitre / **p. 396 - 400**
- Trachéostomie, goitre / **p. 396 - 400**
- Traqueotomía, bocio / **p. 396 - 400**





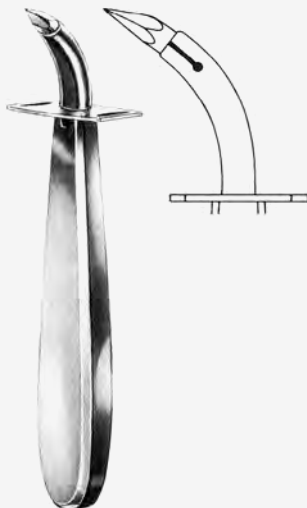

UCKERMANN

13 cm, 5"



26-1075.75

7,5 mm

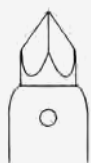

26-1075.90

9,0 mm

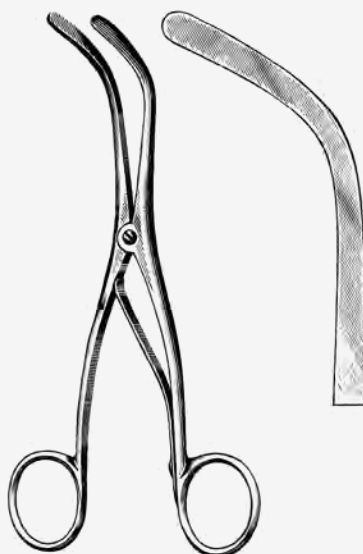

TROUSSEAU

26-1114.14

14 cm, 5 1/2"

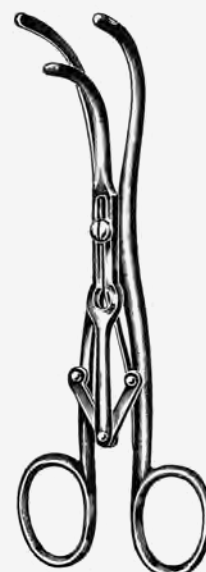

LABORDE

26-1113.14

14 cm, 5 1/2"



BOSE

26-1115.07

7 cm, 2 3/4"



JACKSON

26-1116.15

15 cm, 5 3/4"



JACKSON

26-1117.17

17 cm, 6 3/4"

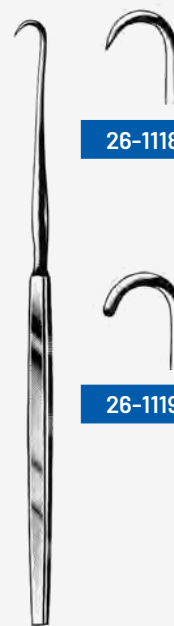

ITERSON

26-1118.16

26-1119.16

16 cm, 6 1/4"



BOSE	
26-1122.16	
16 cm, 6 1/4"	

BOSE	
26-1124.16	
16 cm, 6 1/4"	



ROSE	
26-1130.13	
13 cm, 5"	



WAGENER-MOSHER	
26-1151.05	5 mm
26-1151.07	7 mm
26-1151.09	9 mm



LUER		
26-1220.04	4 mm	Fig. 0
26-1220.05	5 mm	Fig. 1
26-1220.06	6 mm	Fig. 2
26-1220.07	7 mm	Fig. 3
26-1220.08	8 mm	Fig. 4
26-1220.09	9 mm	Fig. 5
26-1220.10	10 mm	Fig. 6
26-1220.11	11 mm	Fig. 7
26-1220.12	12 mm	Fig. 8
26-1220.13	13 mm	Fig. 9



JACKSON		
26-1240.04	4 mm	Fig. 0
26-1240.05	5 mm	Fig. 1
26-1240.06	6 mm	Fig. 2
26-1240.07	7 mm	Fig. 3
26-1240.08	8 mm	Fig. 4
26-1240.09	9 mm	Fig. 5
26-1240.10	10 mm	Fig. 6
26-1240.11	11 mm	Fig. 7
26-1240.12	12 mm	Fig. 8
26-1240.13	13 mm	Fig. 9

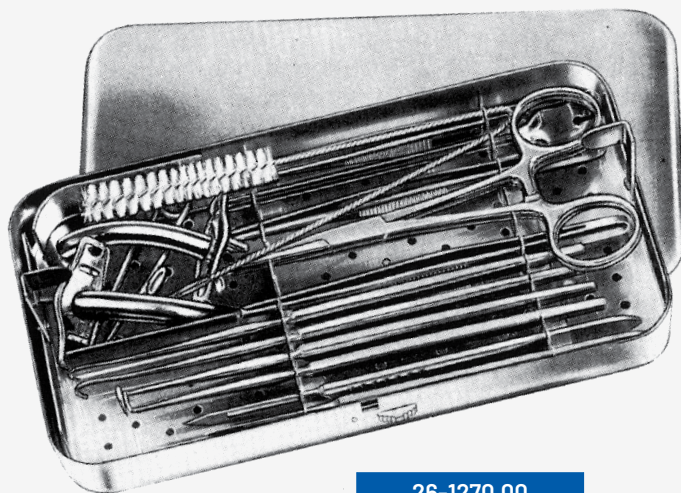

26-1270.00

Tracheotomiebesteck, komplett
 Tracheotomy set, complete
 Jeu d'instruments pour trachéotomie, complet
 Juego para traqueotomía, completo

Kropf • Goitre • Goitre • Bocio



26-1301.15

15 cm, 5 3/4"

KOCHER



26-1303.16

16 cm, 6 1/4"



SCHOENBORN

26-1311.21

21 cm, 8 1/4"



LAHEY

26-1320.15

15 cm, 5 3/4"

26-1320.20

20 cm, 8"



MASTIN

26-1327.17

17 cm, 6 3/4"

Chapter 27

Table of Contents

Thorax, Rippenscheren, Rippenspreizer, Lungeninstrumente / **p. 402 - 414**

Thorax, Rib Shears, Rib Spreader, Lung Instruments / **p. 402 - 414**

Thorax, costotomes, ecarteur des côtes, poumon / **p. 402 - 414**

Tórax, costótomos, separadores costales, pulmón / **p. 402 - 414**





27

Rippenscheren

Rib Shears

Costotomes

Costótomos



27-1402.23

23 cm, 9"



27-1405.22

22 cm, 8 1/2"



GLUCK

27-1407.22

22 cm, 8 1/2"



STILLE

27-1411.21

21 cm, 8 1/4"

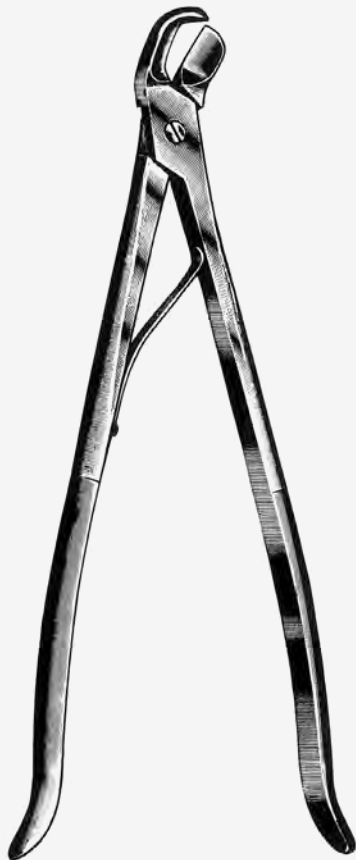

CORYLLOS

27-1423.35

35 cm, 13 3/4"



CORYLLOS

27-1425.35

35 cm, 13 3/4"



BETHUNE

27-1426.34

34 cm, 13 1/4"



SAUERBRUCH

27-1431.26

26 cm, 10 1/4"



GIERTZ-STILLE

27-1437.27

27 cm, 10 1/2"



SAUERBRUCH-FREI

27-1441.36

36 cm, 14"

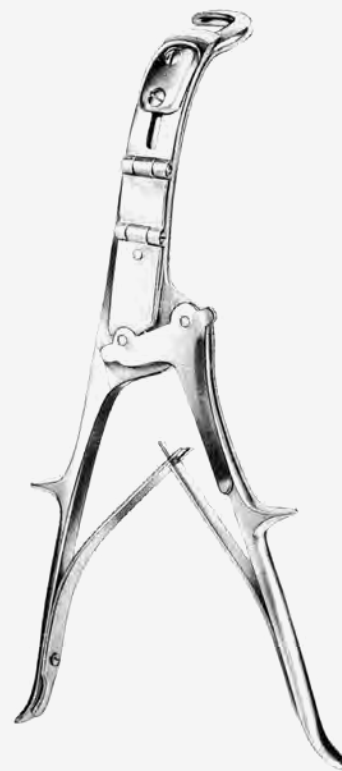

BRUNNER

27-1447.28

28 cm, 11"

27

Rippenscheren
Rib Shears
 Costotomes
 Costótomos

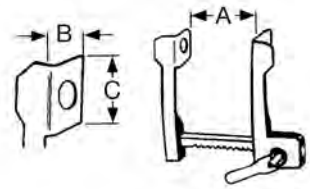

FINOCHIETTO	A	B	C
27-1510.16	165 mm	40 mm	40 mm
27-1510.20	200 mm	45 mm	55 mm
27-1510.25	250 mm	70 mm	65 mm

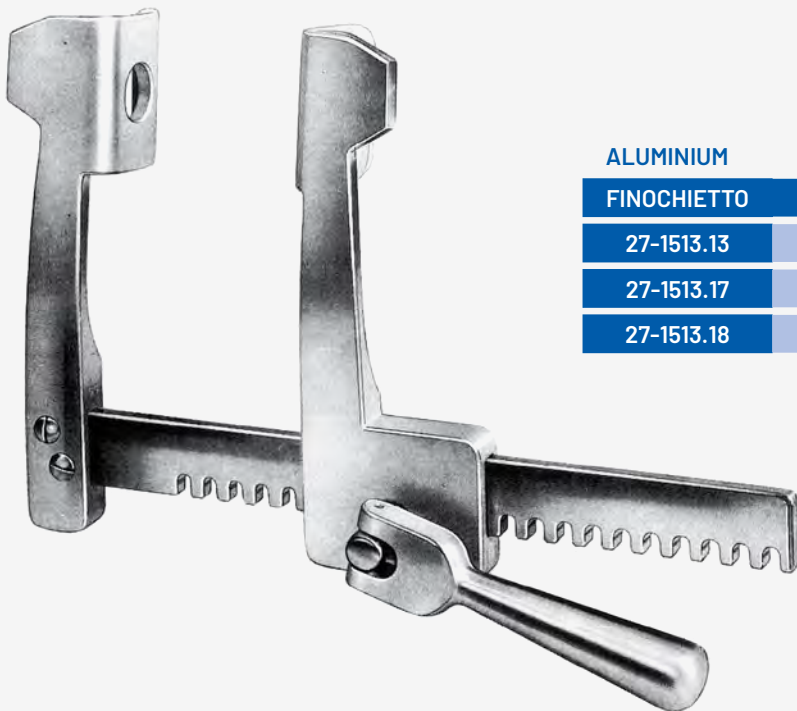

ALUMINIUM			
FINOCHIETTO	A	B	C
27-1513.13	135 mm	38 mm	44 mm
27-1513.17	175 mm	52 mm	62 mm
27-1513.18	175 mm	85 mm	65 mm

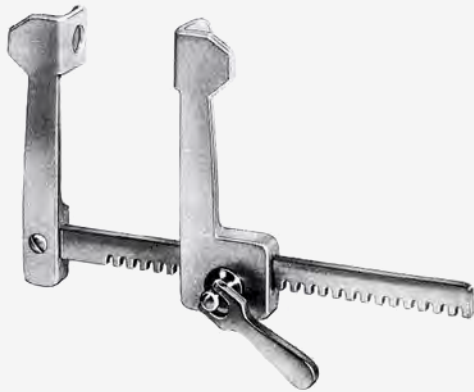
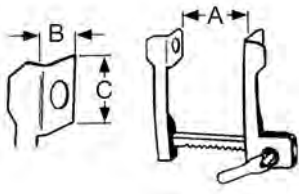

FINOCHIETTO-BABY	A	B	C
27-1514.75	75 mm	18 mm	20 mm

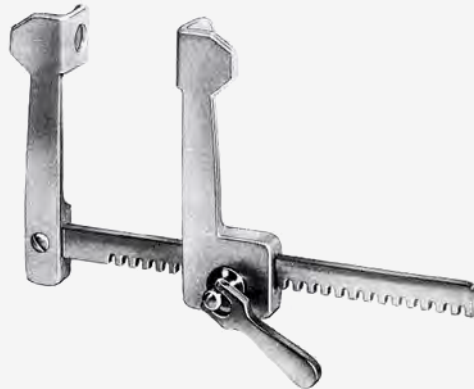

ALUMINIUM

FINOCHIETTO-BABY	A	B	C
27-1534.75	75 mm	15 mm	15 mm

70 x 65 mm

45 x 65 mm



FINOCHIETTO-BURFORD	A	B	C
27-1536.25	250 mm	45 mm	65 mm
		70 mm	65 mm

27

Rippensperrer
Rib Spreaders
 Ecarteurs des cotes
 Separadores costales

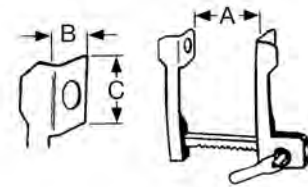

Für Erwachsene
 Adult Size
 pour adultes
 para adultos

47 x 62 mm

65 x 62 mm



ALUMINIUM

FINOCHIETTO-BURFORD	A
27-1542.18	180 mm
27-1542.26	260 mm
27-1542.30	300 mm

B	C
47 mm	62 mm
65 mm	62 mm



Für Kinder
 Child Size
 pour enfants
 para niños

34 x 42 mm

48 x 42 mm



ALUMINIUM

FINOCHIETTO-BURFORD	A	B	C
27-1544.13	135 mm	34 mm	42 mm
		48 mm	42 mm

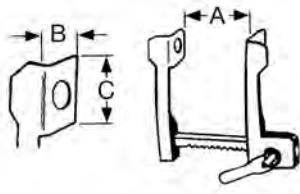

ALUMINIUM

CASTANEDA	A	B	C
27-1550.06	65 mm	10,5 mm	32 mm
27-1550.07	70 mm	12 mm	45 mm
27-1550.12	120 mm	15 mm	60 mm



HAIGHT	A	B	C
27-1560.09	90 mm	30 mm	30 mm



TUFFIER	A	B	C
27-1564.16	165 mm	50 mm	45 mm

27

Rippensperrer
Rib Spreaders
 Ecarteurs des cotes
 Separadores costales

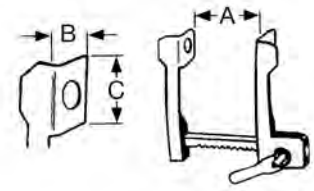

MERCEDES
 27-1570.00

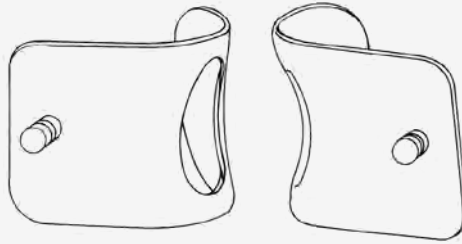

75 x 75 mm (B x C)

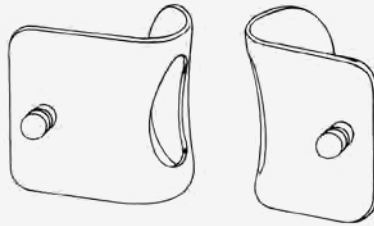

42 x 65 mm (B x C)



SELLORS
 27-1580.19
 19 cm, 7 1/2"



BAILEY-BABY
 27-1582.14
 14 cm, 5 1/2"

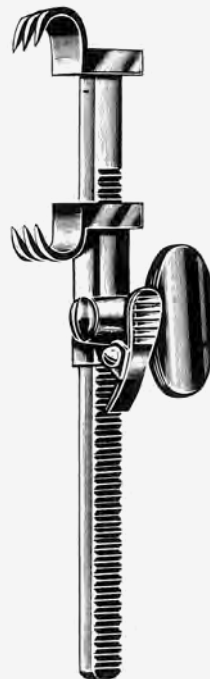

BAILEY
 27-1584.16
 16 cm, 6 1/4"

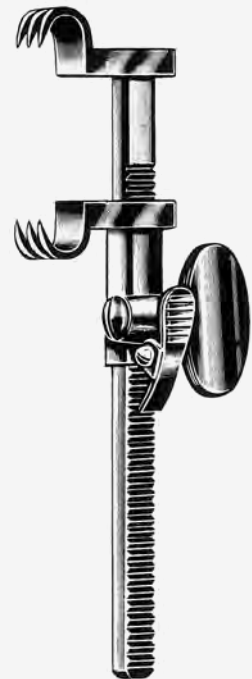

BAILEY-GIBBON
 27-1586.16
 16 cm, 6 1/4"

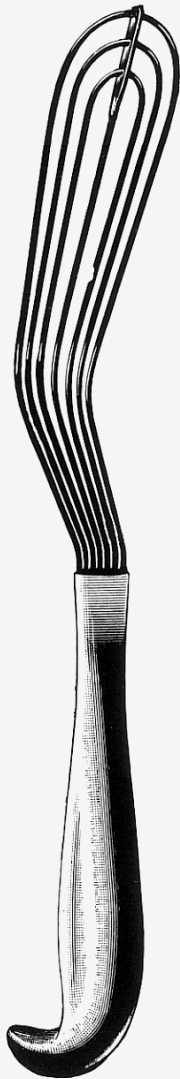

ALLISON

27-1689.32

32 cm, 12 3/4"



LOVELACE

27-1690.20

20 cm, 8"



LOVELACE

27-1691.20

20 cm, 8"

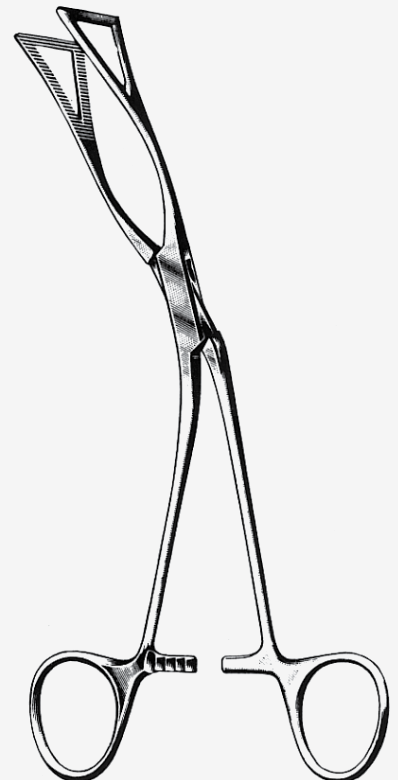

27

Bronchusklemmen
Bronchus Forceps
Pinces clamps pour les bronches
Pinzas clamps bronquiales



HARRINGTON

27-1701.30

30,5 cm, 12 1/4"



HARRINGTON

27-1703.29

29,5 cm, 11 1/2"

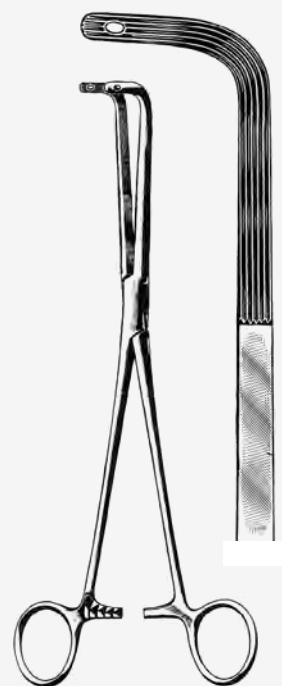

FINOCHIETTO

27-1707.24

24 cm, 9 1/2"



PRICE-THOMAS

27-1709.22

22 cm, 8 1/2"



PRICE-THOMAS

27-1711.22

22 cm, 8 1/2"



PRICE-THOMAS

27-1713.22

22 cm, 8 1/2"



SAROT



27-1717.23

23 cm, 9"



27-1719.23

23 cm, 9"



SEMB



27-1721.23

23 cm, 9"

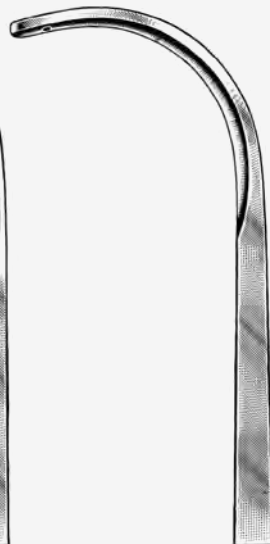

27-1723.23

23 cm, 9"

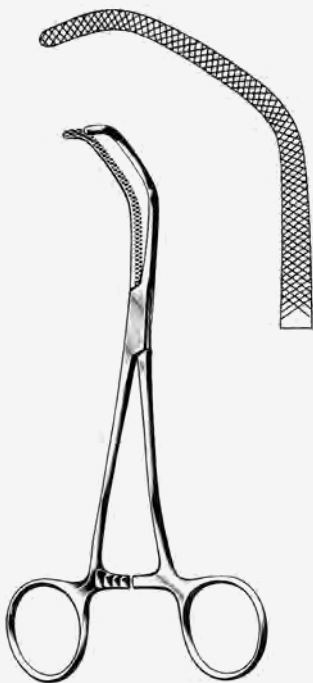

SATINSKY
27-1725.15
15 cm, 5 3/4"



SATINSKY
26 cm, 10 1/4"

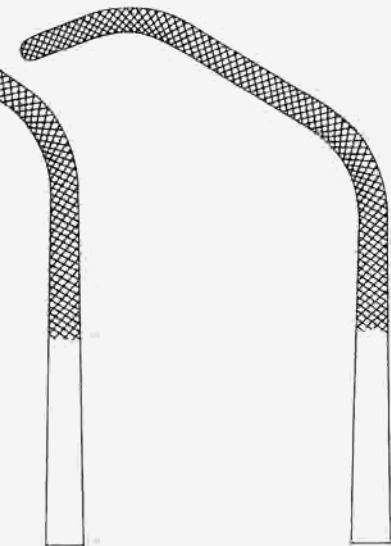

27-1727.26
Fig. 1



27-1729.26
Fig. 2

Chapter 28

Table of Contents

Galle, Niere / **p. 416 - 422**

Gall, Kidney / **p. 416 - 422**

Voies biliaires, rein / **p. 416 - 422**

Vesícula biliar, riñón / **p. 416 - 422**







28-1001.23

Fig. 1



28-1003.23

Fig. 2



BLAKE

28-1006.20

20 cm, 8"



BLAKE

28-1007.20

20 cm, 8"



MAYO-BLAKE

28-1010.20

20 cm, 8"



MAYO-BLAKE

28-1011.20

20 cm, 8"



MIXTER

28-1017.22

22 cm, 8 1/2"



MOORE

28-1025.28

28 cm, 11"

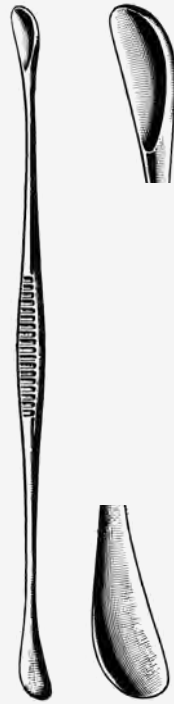

FERGUSSON

28-1070.21

21,5 cm, 8 1/4"



MAYO

28-1075.27

27 cm, 10 1/2"



MAYO



28-1078.01

27 cm, 10 1/2"



28-1078.02

27 cm, 10 1/2"



DESJARDINGS



28-1080.17

Charr. 17



28-1080.21

Charr. 21



28-1080.24

Charr. 24



28-1080.27

Charr. 27



DESJARDINGS

28 cm, 11"



28-1030.13

Charr. 13



28-1030.18

Charr. 18



28-1030.21

Charr. 21



OCHSNER

28-1028.35

35 cm, 13 3/4"



MOYNIHAN

28-1042.34

34 cm, 13 1/4"



BAKES
28-1049.00
 30 cm, 12"

Satz von 9 Dilatationsoliven (28-1050.03 - 28-1050.11)
 Set of 9 dilators (28-1050.03 - 28-1050.11)
 Jeu de 9 dilateurs (28-1050.03 - 28-1050.11)
 Juego de 9 dilatadores (28-1050.03 - 28-1050.11)

BAKES
28-1050.00
 30 cm, 12"

Satz von 13 Dilatationsoliven (28-1050.01 - 28-1050.13)
 Set of 13 dilators (28-1050.01 - 28-1050.13)
 Jeu de 13 dilateurs (28-1050.01 - 28-1050.13)
 Juego de 13 dilatadores (28-1050.01 - 28-1050.13)

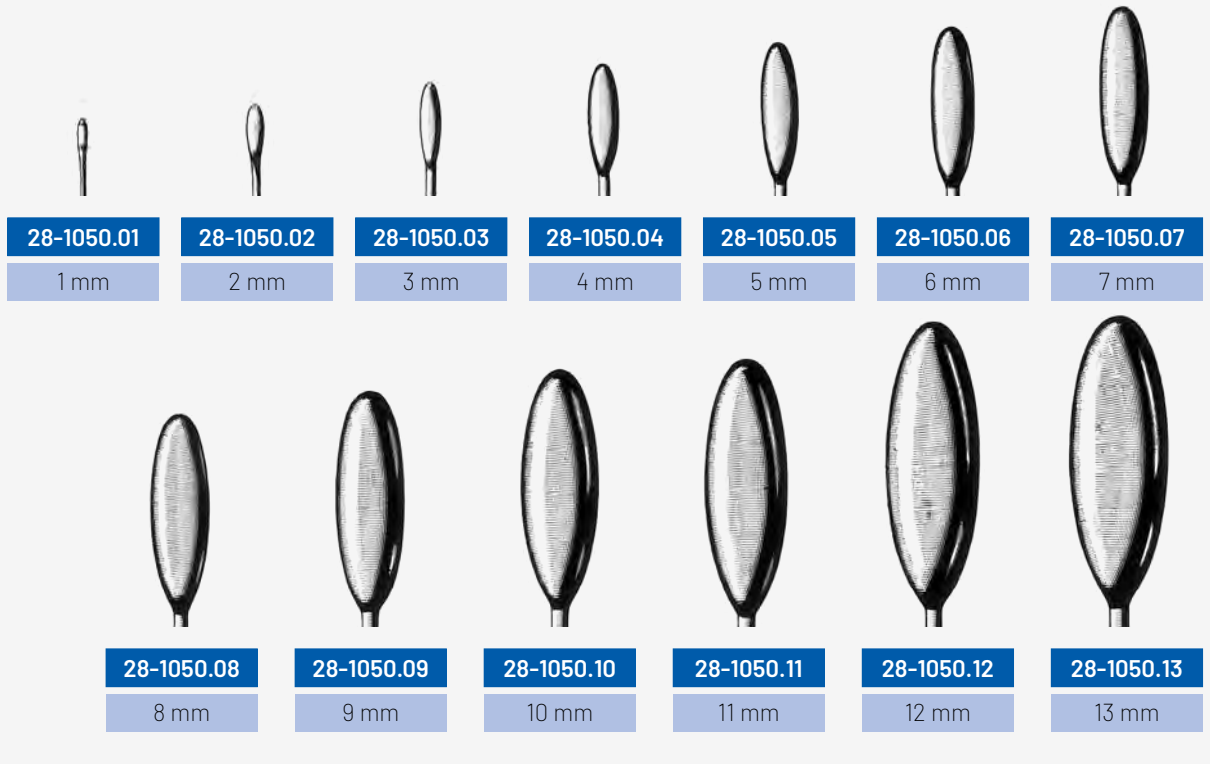

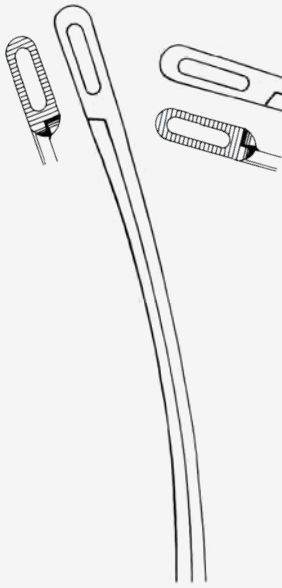

28-1131.01
Fig. 1

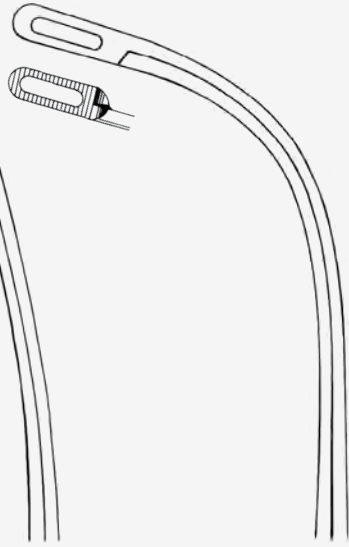

28-1131.02
Fig. 2

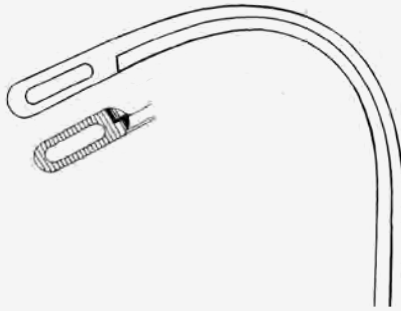

28-1131.03
Fig. 3

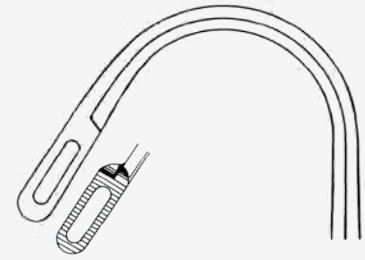

28-1131.04
Fig. 4



RANDALL

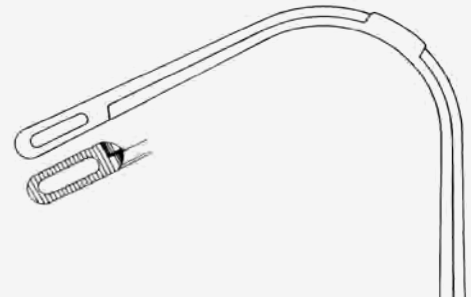

28-1131.05
Fig. 5

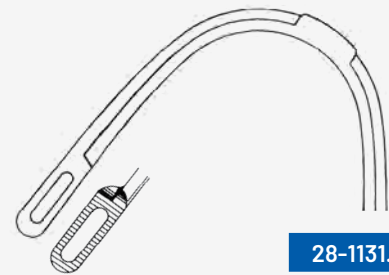

28-1131.06
Fig. 6

**MAYO****28-1110.32**

32 cm, 12 3/4"

**LURZ****28-1121.21**

21 cm, 8 1/4"

**LURZ****28-1123.21**

21 cm, 8 1/4"

Chapter 29

Table of Contents

Magen, Darm / **p. 424 - 435**

Intestines, Stomach / **p. 424 - 435**

Intestin, estomac / **p. 424 - 435**

Intestinos, estómago / **p. 424 - 435**







ALLIS-BABY
 29-1002.14
 14 cm, 5 1/2"



ALLIS
 29-1010.15
 15 cm, 5 3/4"



ALLIS-ADAIR
 29-1030.15
 15,5 cm, 5 3/4"



THOMS-ALLIS
 29-1040.20
 20 cm, 8"



ALLIS

29-1020.15	15 cm, 5 3/4"
29-1020.19	19 cm, 7 1/2"
29-1020.22	22 cm, 8 1/2"
29-1020.24	24 cm, 9 1/2"



ALLIS

29-1024.16	16 cm, 6 1/4"
29-1024.20	20 cm, 8"
29-1024.25	25 cm, 10"

atraumatisch
 atraumatic
 atraumatique
 atraumática



JUDD-ALLIS

29-1040.15	15 cm, 5 3/4"
29-1040.19	19 cm, 7 1/2"



BABCOCK

29-1060.16	16 cm, 6 1/4"
29-1060.18	18 cm, 7"
29-1060.20	20 cm, 8"
29-1060.24	24 cm, 9 1/2"



Hartmetall Einlagen
 Tungsten Carbide Inserts

BABCOCK

29-1064.16	16 cm, 6 1/4"
29-1064.20	20 cm, 8"



atraumatisch
 atraumatic
 atraumatique
 atraumática

BABCOCK

29-1068.16	16 cm, 6 1/4"
29-1068.20	20 cm, 8"

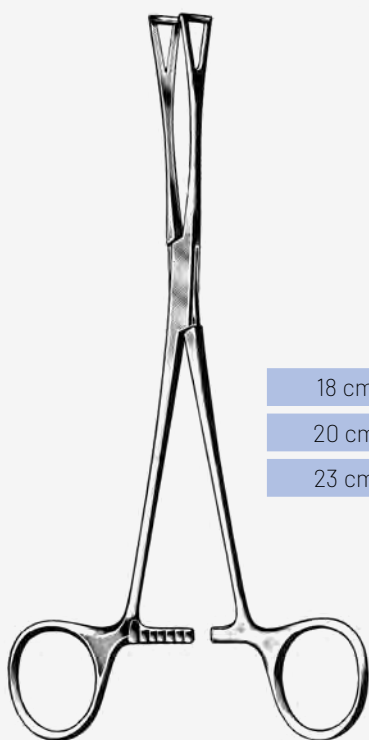

DUVAL

18 cm, 7"	29-1070.18
20 cm, 8"	29-1070.20
23 cm, 9"	

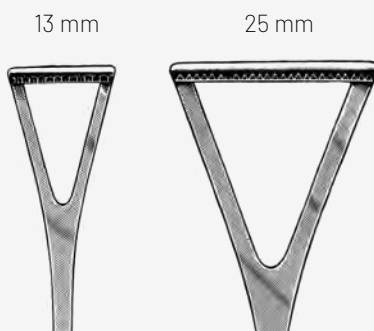

29-1072.20
29-1072.23



Hartmetall
 Tungsten Carbide

DUVAL

29-1074.20
20 cm, 8"



WILLIAMS
 29-1080.16
 16,5 cm, 6 1/2"



SCHOENBURG
 29-1082.22
 22 cm, 8 1/2"



DOYEN-BABY

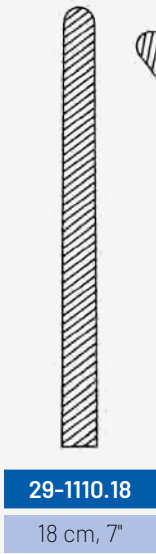

DOYEN

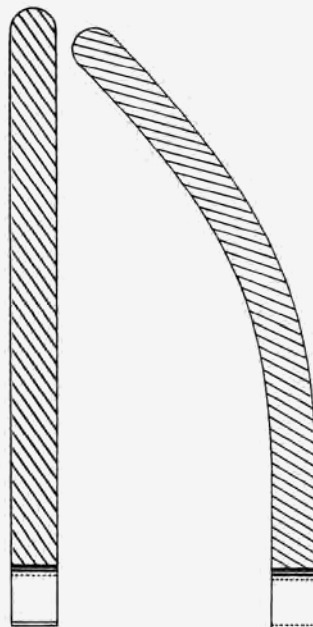

21 cm, 8 1/4"
 23 cm, 9"

29-1110.21
29-1110.23

29-1111.21
29-1111.23

atraumatisch
 atraumatic
 atraumatique
 atraumática

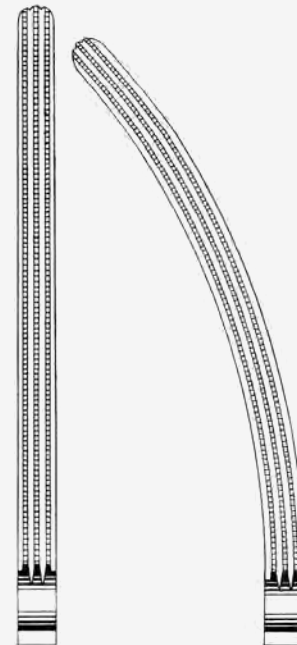

16 cm, 6 1/4"
 18 cm, 7"
 21 cm, 8 1/4"
 23 cm, 9"

29-1116.16
29-1116.18
29-1116.21
29-1116.23

29-1117.16
29-1117.18
29-1117.21
29-1117.23



KOCHER

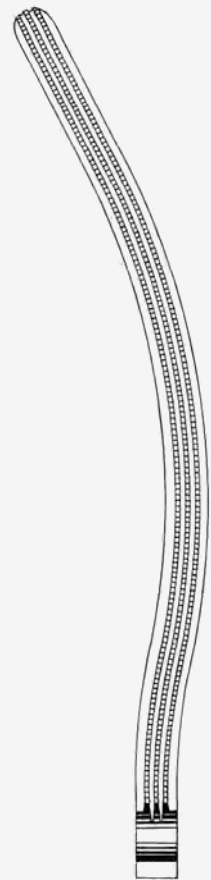

22 cm, 8 1/2" **29-1120.22**

25 cm, 10" **29-1120.25**

28 cm, 11" **29-1120.28**

29-1121.22

29-1121.25

29-1121.28

29-1126.22

29-1126.25

29-1126.28

29-1127.22

29-1127.25

29-1127.28

atraumatisch
 atraumatic
 atraumatique
 atraumática

atraumatisch
 atraumatic
 atraumatique
 atraumática



MAYO-ROBSON



29-1130.25
 25 cm, 10"

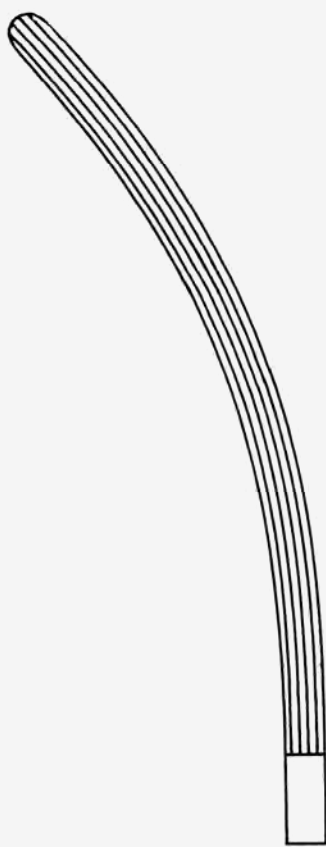

29-1131.25
 25 cm, 10"



29-1136.25
 25 cm, 10"

atraumatisch
 atraumatic
 atraumatique
 atraumática

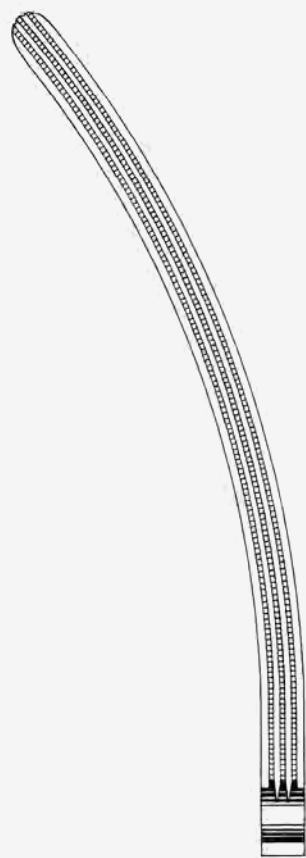

29-1137.25
 25 cm, 10"

atraumatisch
 atraumatic
 atraumatique
 atraumática



FEHLAND

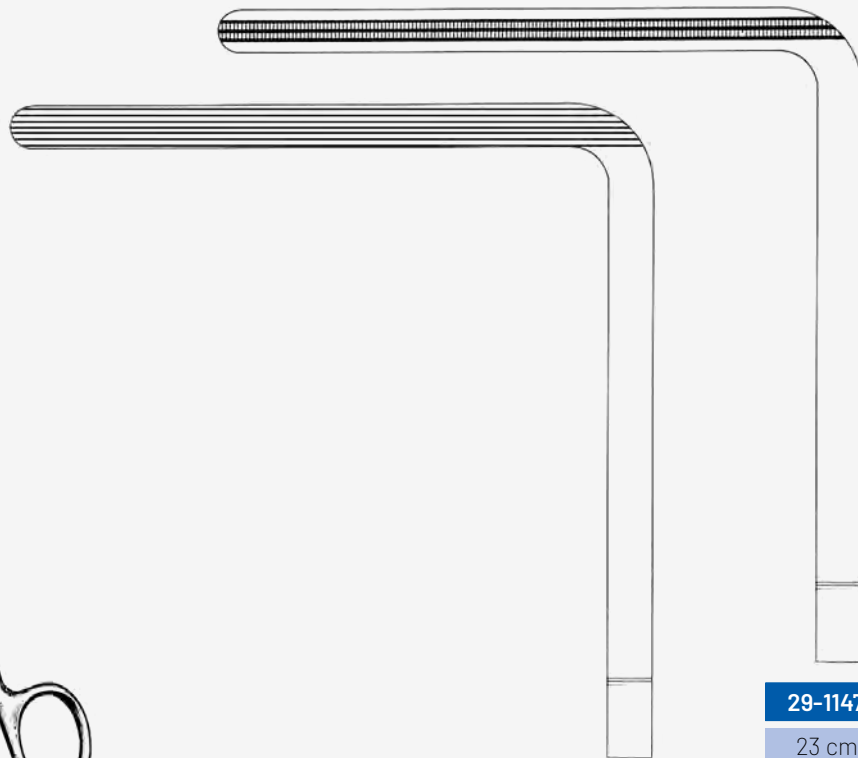

29-1141.23

23 cm, 9"

29-1147.23

23 cm, 9"

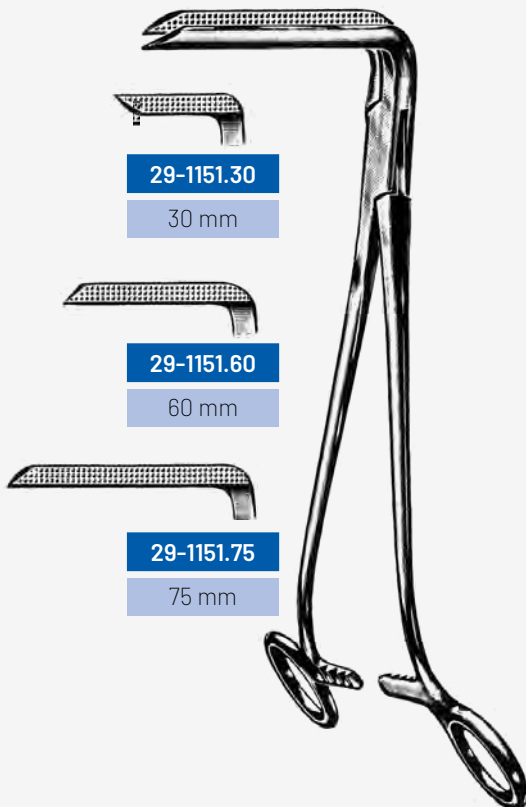

29-1151.30

30 mm

29-1151.60

60 mm

29-1151.75

75 mm

BEST

26,5 cm, 10 1/2"



BRUNNER

29-1160.24

24 cm, 9 1/2"

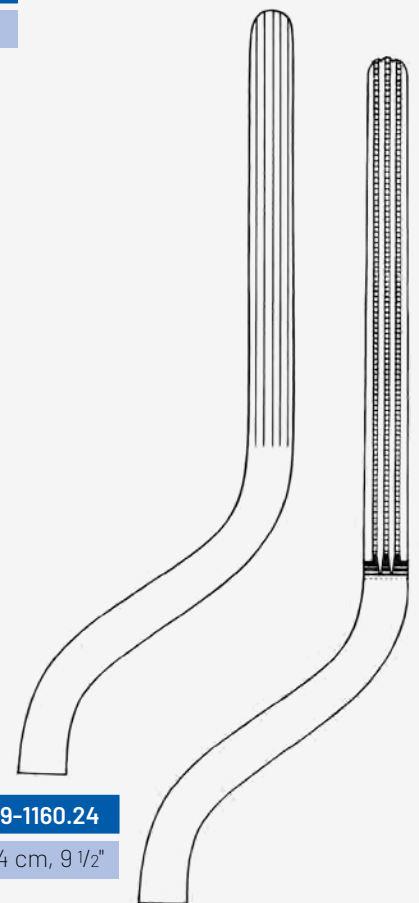

29-1166.24

24 cm, 9 1/2"



STONE
 29-1170.15
 15,5 cm, 6"



STONE-WATT
 29-1172.07 7,5 cm, 3"
 29-1172.10 10 cm, 4"



STONE-WATT
 29-1174.00



DE MARTEL-WOLFSON
 29-1180.05 5 cm, 2"
 29-1180.07 7 cm, 2 2/4"
 29-1180.10 10 cm, 4"



DE MARTEL-WOLFSON
 29-1182.26
 26 cm, 10 1/4"



DE MARTEL-WOLFSON
 29-1184.08
 8,5 cm, 3 1/2"

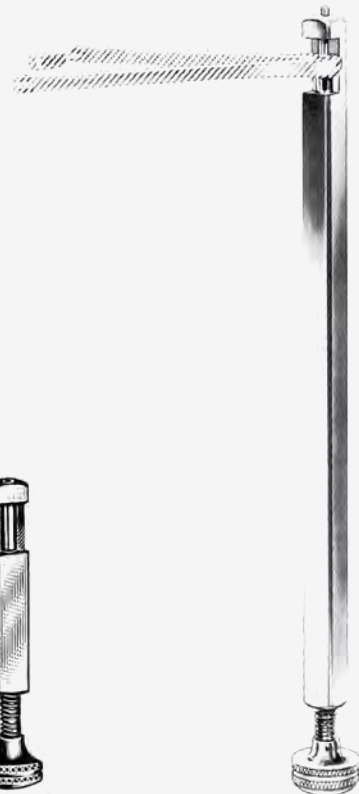

DE MARTEL-WOLFSON
 29-1184.23
 23 cm, 9"

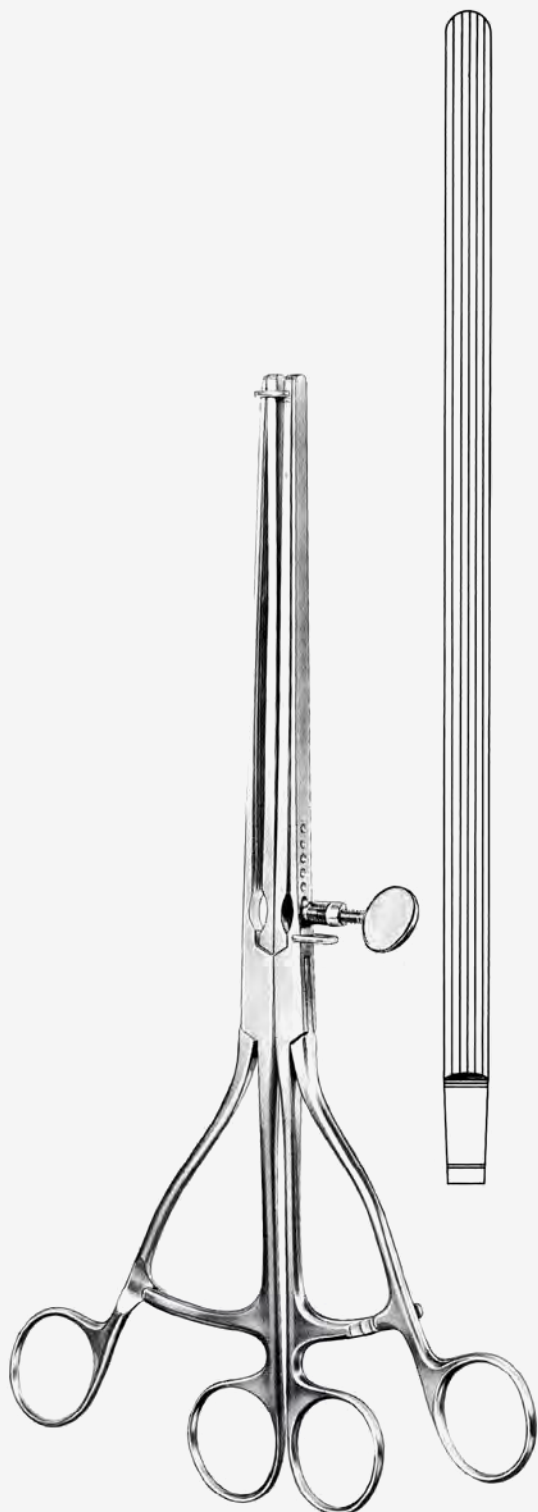

LANE
29-1190.30
30 cm, 12"



LANE
29-1191.30
30 cm, 12"

29

Darm, Magen
Intestines and Stomach
Intestin et estomac
Intestinos y estómago

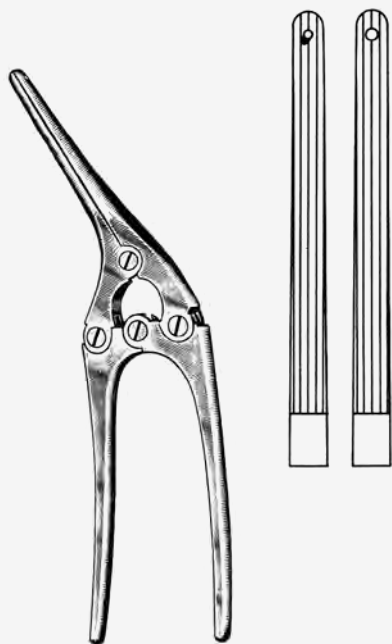

PAYR-BABY

29-1210.15

15 cm, 5 3/4"

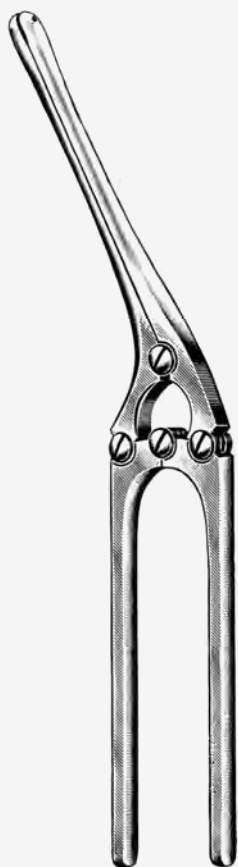

PAYR

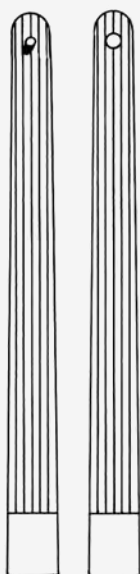

29-1210.21

21 cm, 8 1/4"

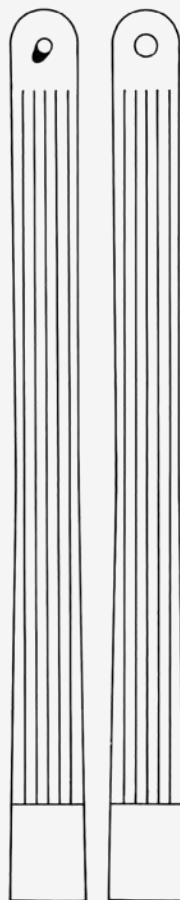

29-1210.29

29 cm, 11 1/4"

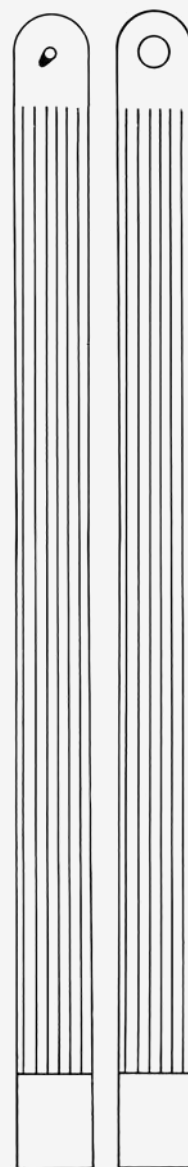

29-1210.35

35 cm, 13 3/4"

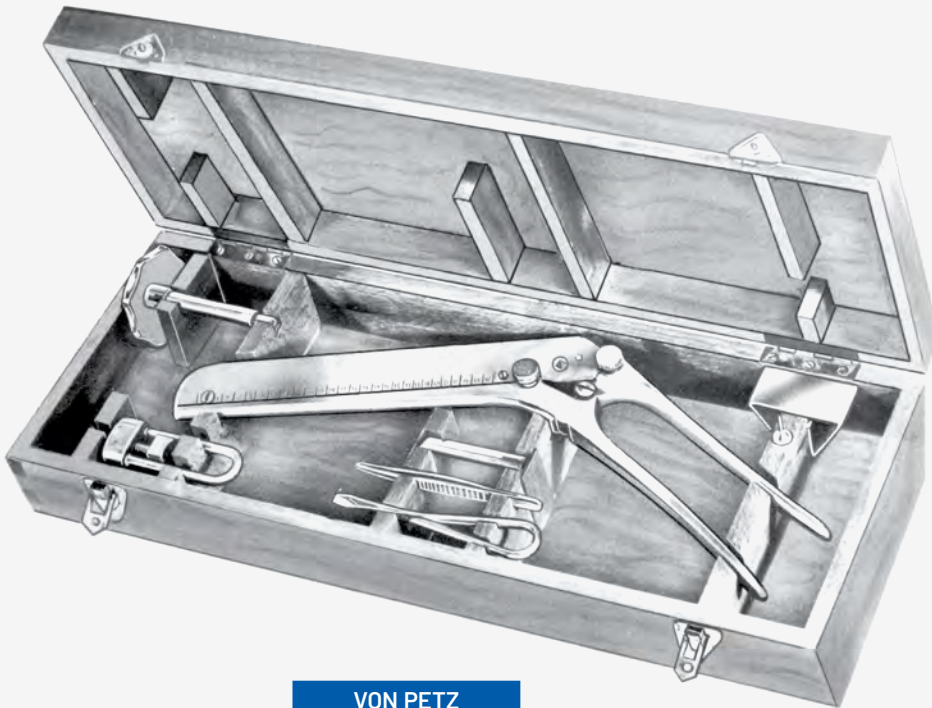

VON PETZ

29-1220.00

compl.



300 Stück
300 ea.
300 pièces
300 c/u

29-1221.00

Chapter 30

Table of Contents

Urologie / p. 436 - 444

Urology / p. 436 - 444

Urologie / p. 436 - 444

Urología / p. 436 - 444





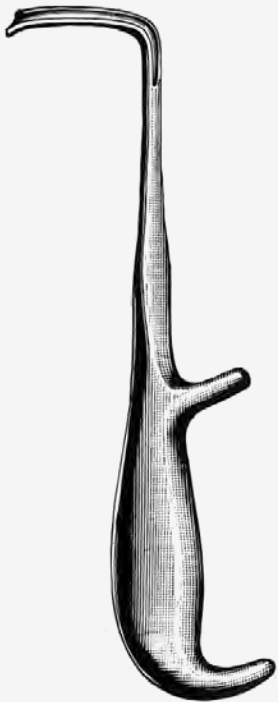

YOUNG
30-1301.21
 21 cm, 8 1/4"

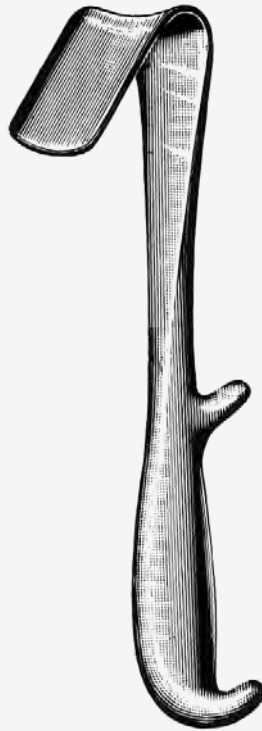

YOUNG
30-1303.21
 22 cm, 8 1/2"

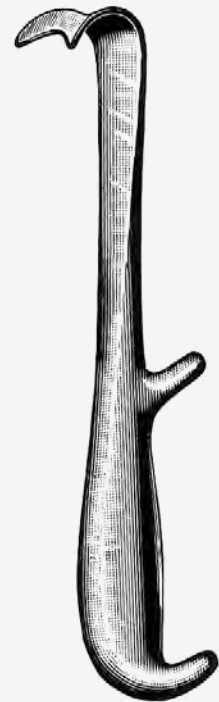

YOUNG
30-1305.21
 21 cm, 8 1/4"

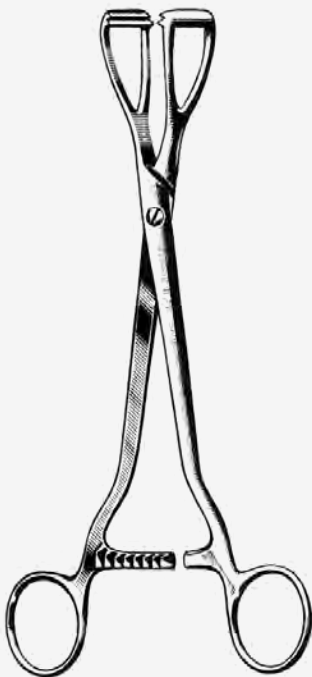

YOUNG
30-1306.20
 20 cm, 8"



MILLIN
30-1311.23
 23 cm, 9"

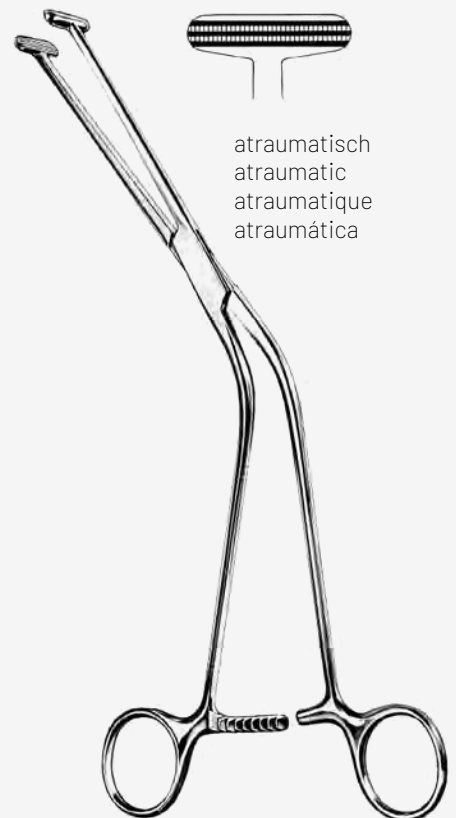

MILLIN
30-1313.23
 23 cm, 9"

atraumatisch
 atraumatic
 atraumatique
 atraumática



MILLIN

30-1323.23

23 cm, 9"



MILLIN

30-1325.24

24 cm, 9 1/2"



MILLIN

30-1365.00



JUDD-MASSON

30-1350.00



LEGUEU

30-1363.00



THOMSON-WALKER
 30-1360.00



LEGUEU
 30-1347.27
 27 cm, 10 1/2"



KOCHER
 30-1349.27
 27 cm, 10 1/2"

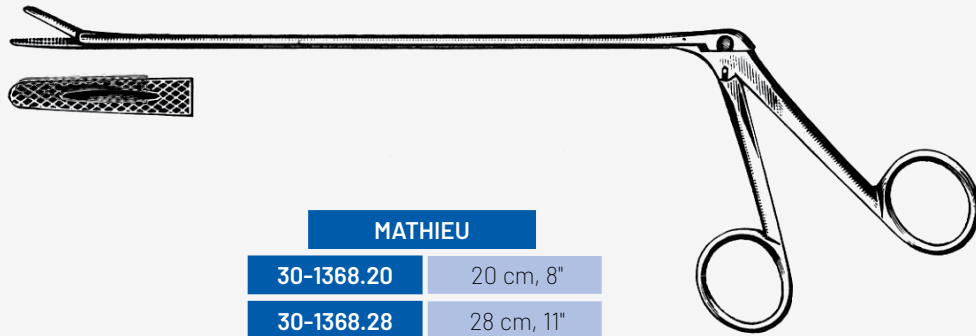

MATHIEU

30-1368.20 20 cm, 8"

30-1368.28 28 cm, 11"

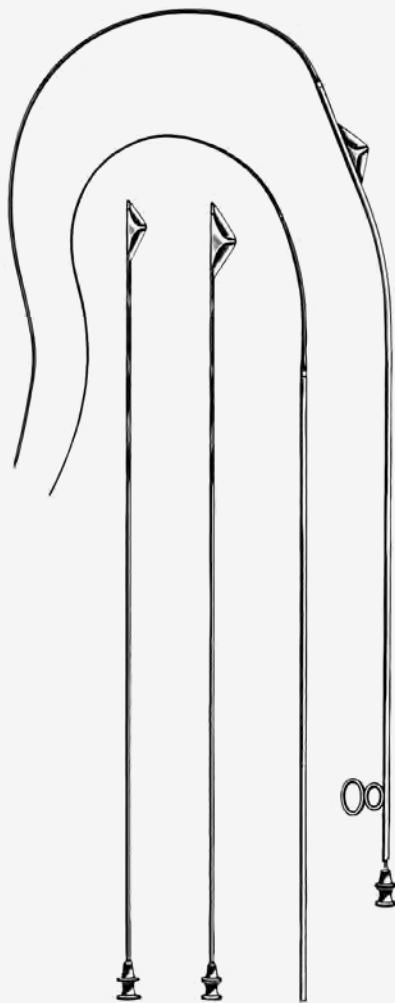

MAISONNEUVE

30-1370.00

komplett mit Holzetui (30-1370.01)
 complete with wooden case (30-1370.01)
 complet avec boîte bois (30-1370.01)
 completo con estuche de madera (30-1370.01)



STOCKMANN

30-1475.08

8 cm, 3 1/4"



STRAUSS

30-1477.11

11 cm, 4 1/4"



GUTMANN
30-1480.26
26 cm, 10 1/4"



GUYON
30-1484.39
39 cm, 15 1/2"

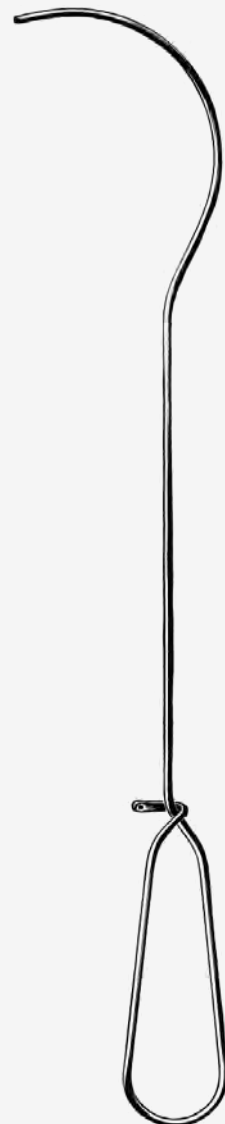

GUYON
30-1485.35
35 cm, 13 3/4"



GUYON

30-1500.00

Harnröhren-Dilatationsbesteck
 Urethral Dilation Set
 Jeu d'instruments pour la dilatation de l'urètre
 Juego de instrumentos para la dilatación de la uretra



VAN BUREN

30-1501.08	Charr. 8
30-1501.10	Charr. 10
30-1501.12	Charr. 12
30-1501.14	Charr. 14
30-1501.16	Charr. 16
30-1501.18	Charr. 18
30-1501.20	Charr. 20
30-1501.22	Charr. 22
30-1501.24	Charr. 24
30-1501.26	Charr. 26
30-1501.28	Charr. 28
30-1501.30	Charr. 30
30-1501.32	Charr. 32
30-1501.34	Charr. 34
30-1501.36	Charr. 36



GUYON

30-1505.08	Charr. 8	30-1505.24	Charr. 24
30-1505.09	Charr. 9	30-1505.26	Charr. 26
30-1505.10	Charr. 10	30-1505.28	Charr. 28
30-1505.11	Charr. 11	30-1505.30	Charr. 30
30-1505.12	Charr. 12	30-1505.32	Charr. 32
30-1505.14	Charr. 14	30-1505.34	Charr. 34
30-1505.16	Charr. 16	30-1505.36	Charr. 36
30-1505.18	Charr. 18	30-1505.38	Charr. 38
30-1505.20	Charr. 20	30-1505.39	Charr. 39
30-1505.22	Charr. 22	30-1505.40	Charr. 40

30-1501.00

Set: 30-1501.00 - 30-1501-36



für Männer
 male catheters
 pour hommes
 para hombres

30-1511.08	Charr. 8
30-1511.10	Charr. 10
30-1511.12	Charr. 12
30-1511.14	Charr. 14
30-1511.16	Charr. 16
30-1511.18	Charr. 18
30-1511.20	Charr. 20
30-1511.22	Charr. 22
30-1511.24	Charr. 24



für Frauen
 female catheters
 pour femmes
 para mujeres

30-1513.08	Charr. 8
30-1513.10	Charr. 10
30-1513.12	Charr. 12
30-1513.14	Charr. 14
30-1513.16	Charr. 16
30-1513.18	Charr. 18
30-1513.20	Charr. 20
30-1513.22	Charr. 22
30-1513.24	Charr. 24



für Frauen
 female catheters
 pour femmes
 para mujeres

COXETER	
30-1519.08	Charr. 8
30-1519.10	Charr. 10
30-1519.12	Charr. 12
30-1519.14	Charr. 14
30-1519.16	Charr. 16
30-1519.18	Charr. 18
30-1519.20	Charr. 20
30-1519.22	Charr. 22
30-1519.24	Charr. 24

Chapter 31

Table of Contents

Rektum / **p. 446 - 452**

Rectum / **p. 446 - 452**

Rectum / **p. 446 - 452**

Recto / **p. 446 - 452**







SIMS
 31-1110.15
 15 cm, 5 3/4"



BODENHAMMER
 31-1115.15
 15 cm, 5 3/4"

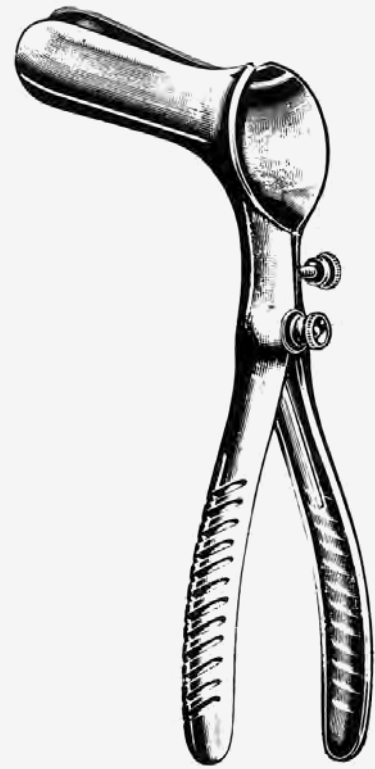

PRATT
 31-1121.22
 22 cm, 8 1/2"



BARR
 31-1125.17
 17 cm, 6 3/4"



MATHIEU
 31-1130.19
 19,5 cm, 7 3/4"



CZERNY
 31-1105.22
 22 cm, 8 1/2"



ALLAN-PARKS

31-1147.00

13,5 cm, 5 1/4"

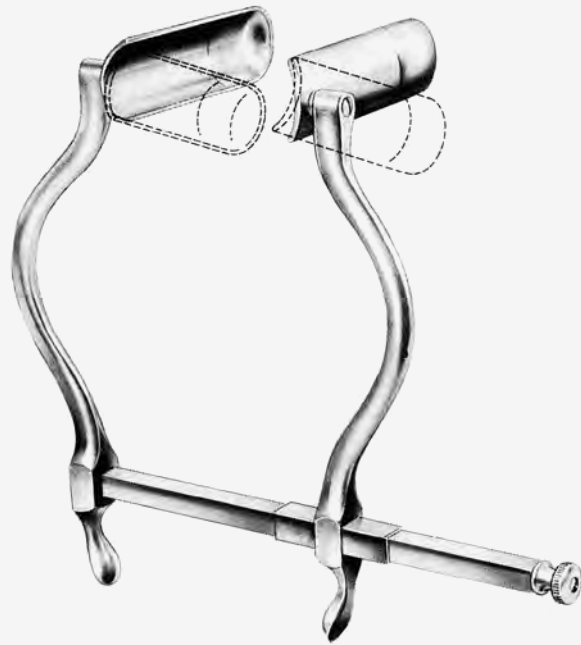

SMITH-BUIE

31-1150.15

15 cm, 5 3/4"



STRAUSS

31-1160.00

komplett mit Holzetui
complete with wooden case
complet avec boîte bois
completo con estuche de madera



IVES-FANSLER
31-1210.22
 Ø 22 mm



HIRSCHMANN

31-1212.16	16 mm
31-1212.19	19 mm
31-1212.22	22 mm



KELLY
31-1224.21 21 x 50 mm
31-1224.27 27 x 50 mm

KELLY

31-1220.05	22 x 50 mm
31-1220.10	22 x 100 mm
31-1220.14	22 x 140 mm
31-1220.20	22 x 200 mm



PRATT

Cystikus-Haken
Cystic Hooks
Ecarteurs rectaux
Ganchos rectales



31-1251.01

Fig. 1



31-1251.02

Fig. 2



31-1251.03

Fig. 3

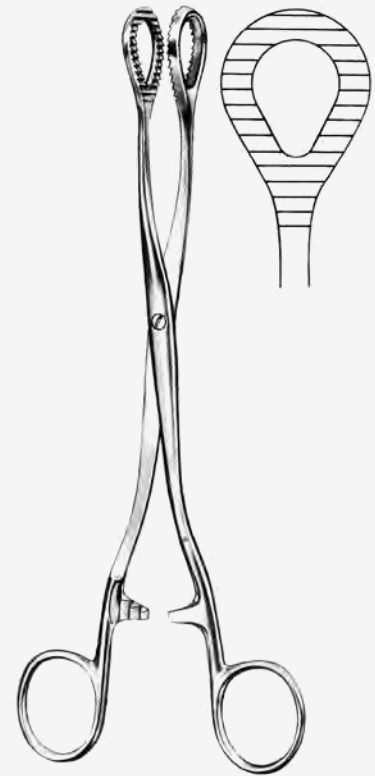

HEYWOOD-SMITH

31-1402.21

21 cm, 8 1/4"



BUIE

31-1261.41

41 cm, 16 1/2"

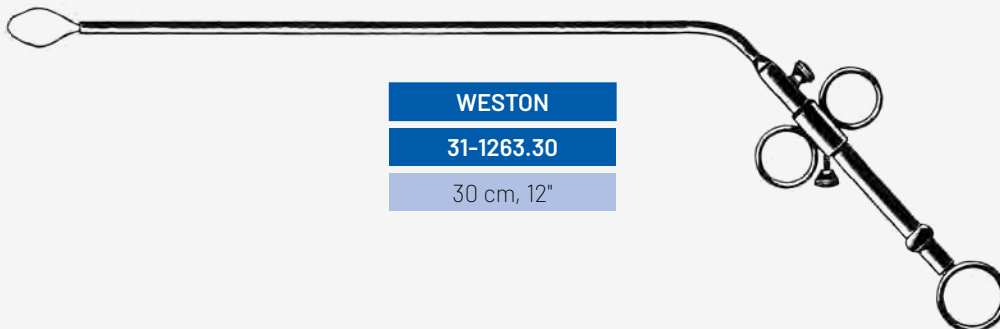

WESTON

31-1263.30

30 cm, 12"

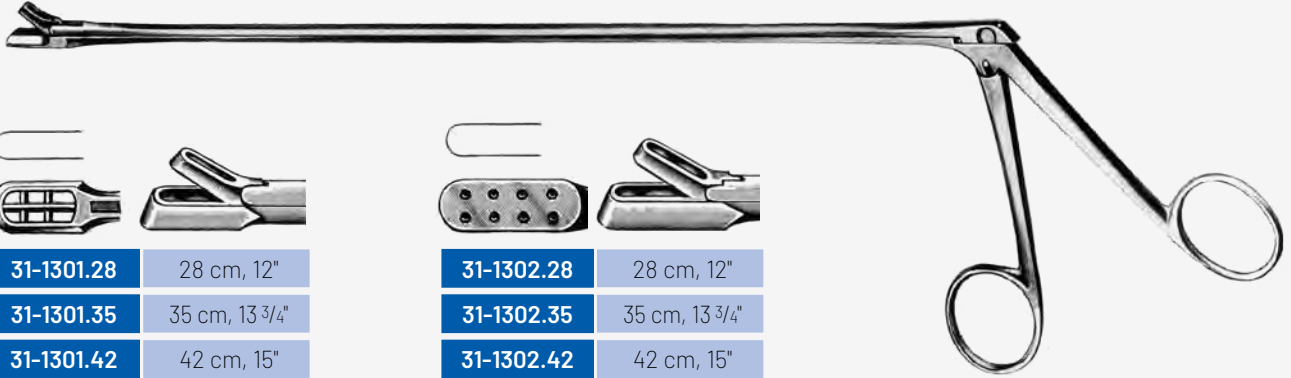

31-1301.28	28 cm, 12"
31-1301.35	35 cm, 13 3/4"
31-1301.42	42 cm, 15"



31-1302.28	28 cm, 12"
31-1302.35	35 cm, 13 3/4"
31-1302.42	42 cm, 15"

YEOMAN



31-1303.28	28 cm, 12"
31-1303.35	35 cm, 13 3/4"
31-1303.42	42 cm, 15"



31-1304.28	28 cm, 12"
31-1304.35	35 cm, 13 3/4"
31-1304.42	42 cm, 15"

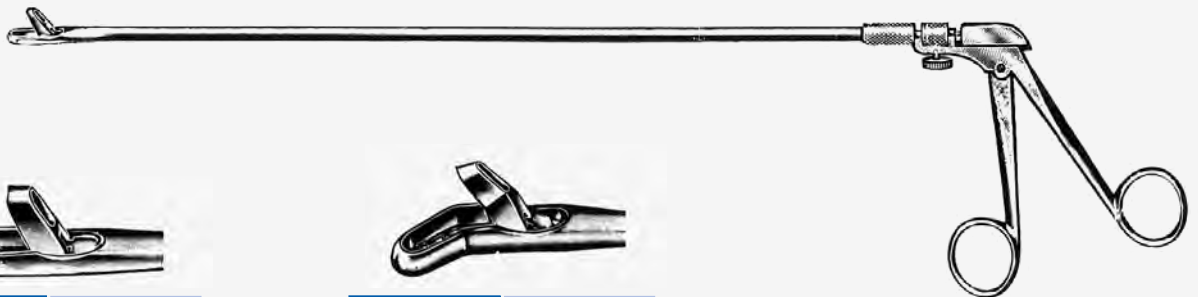

31-1311.23	23 cm, 9"
31-1311.33	33 cm, 13"
31-1311.40	40 cm, 16"



31-1321.23	23 cm, 9"
31-1321.33	33 cm, 13"
31-1321.40	40 cm, 16"

TURREL

drehbar
 rotatable
 rotative
 giratoria

Chapter 32

Table of Contents

Gynäkologie / **p. 454 - 483**

Gynecology / **p. 454 - 483**

Gynécologie / **p. 454 - 483**

Ginecología / **p. 454 - 483**







GRAVE		
32-1010.01	Fig. 1	75 x 20 mm
32-1010.02	Fig. 2	95 x 35 mm
32-1010.03	Fig. 3	115 x 35 mm



PEDDERSON		
32-1020.01	Fig. 1	75 x 13 mm
32-1020.02	Fig. 2	100 x 22 mm
32-1020.03	Fig. 3	120 x 25 mm

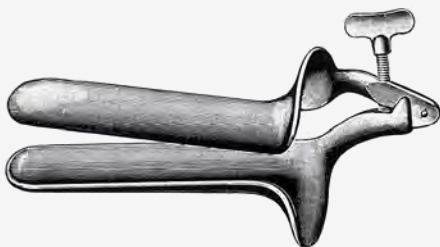

COLLIN		
32-1030.01	Fig. 1	85 x 30 mm
32-1030.02	Fig. 2	100 x 35 mm
32-1030.03	Fig. 3	110 x 40 mm

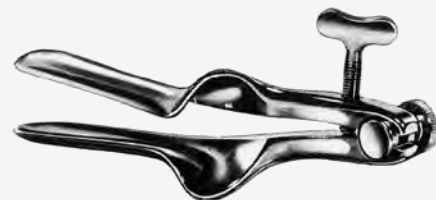

COLLIN	
32-1031.00	65 x 20 mm



COLLIN	
32-1032.00	65 x 10 mm



CUSCO		
32-1040.01	Fig. 1	75 x 32 mm
32-1040.02	Fig. 2	85 x 35 mm
32-1040.03	Fig. 3	100 x 35 mm



CUSCO		
32-1050.01	Fig. 1	75 x 32 mm
32-1050.02	Fig. 2	85 x 36 mm
32-1050.03	Fig. 3	95 x 37 mm



Schweizer Modell
 Swiss Pattern
 Modèle suisse
 Modelo suizo

CUSCO		
32-1060.01	Fig. 1	90 x 23-25 mm
32-1060.02	Fig. 2	100 x 25-27 mm
32-1060.03	Fig. 3	110 x 27-30 mm



CUSCO		
32-1042.00		75 x 17 mm

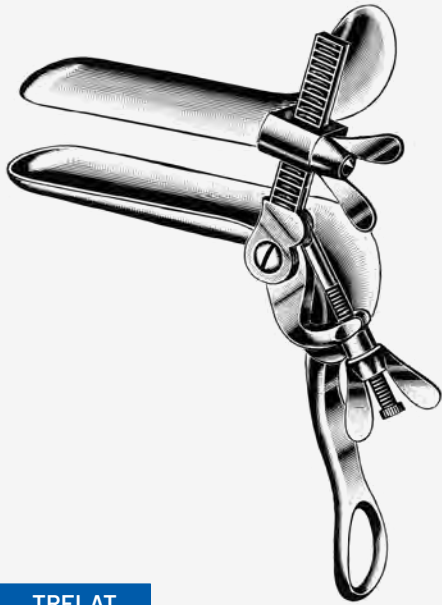

TRELAT		
32-1080.01	Fig. 1	85 x 33 mm
32-1080.02	Fig. 2	95 x 35 mm
32-1080.03	Fig. 3	115 x 43 mm



SEMM	
32-1090.01	100 x 17-20 mm
32-1090.02	100 x 25-30 mm



Satz
 Set
 Jeu
 Juego

KRISTELLER		
32-1110.01	Fig. 1	
32-1110.02	Fig. 2	
32-1110.03	Fig. 3	

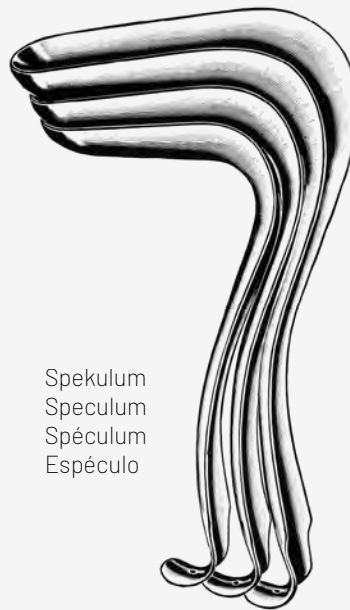

Spekulum
 Speculum
 Spéculum
 Espéculo

KRISTELLER		
32-1111.01	Fig. 1	
32-1111.02	Fig. 2	
32-1111.03	Fig. 3	

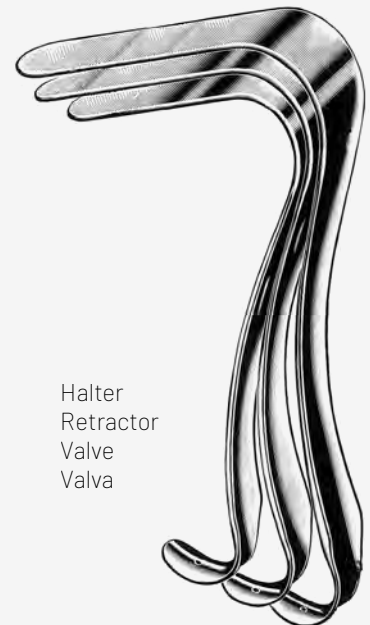

Halter
 Retractor
 Valve
 Valva

KRISTELLER		
32-1112.01	Fig. 1	
32-1112.02	Fig. 2	
32-1112.03	Fig. 3	



für Jungfrauen
 for virgins
 pour vierges
 para vírgenes

Satz
 Set
 Jeu
 Juego

KRISTELLER	
32-1120.01	Fig. 1
32-1120.02	Fig. 2



Spekulum
 Speculum
 Spéculum
 Espéculo

KRISTELLER	
32-1121.01	Fig. 1
32-1121.02	Fig. 2



Halter
 Retractor
 Valve
 Valva

KRISTELLER	
32-1122.01	Fig. 1
32-1122.02	Fig. 2



Satz
 Set
 Jeu
 Juego

KRISTELLER	
32-1130.01	Fig. 1
32-1130.02	Fig. 2
32-1130.03	Fig. 3



Spekulum
 Speculum
 Spéculum
 Espéculo

KRISTELLER	
32-1131.01	Fig. 1
32-1131.02	Fig. 2
32-1131.03	Fig. 3



Halter
 Retractor
 Valve
 Valva

KRISTELLER	
32-1132.01	Fig. 1
32-1132.02	Fig. 2
32-1132.03	Fig. 3



Satz
 Set
 Jeu
 Juego

KRISTELLER	
32-1140.01	Fig. 1
32-1140.02	Fig. 2
32-1140.03	Fig. 3

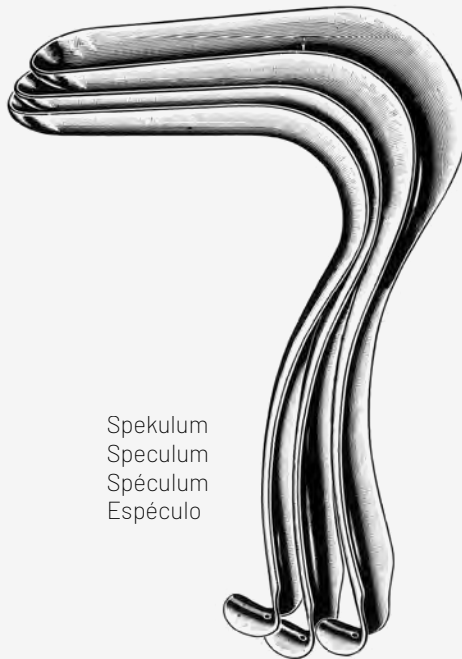

Spekulum
 Speculum
 Spéculum
 Espéculo

KRISTELLER	
32-1141.01	Fig. 1
32-1141.02	Fig. 2
32-1141.03	Fig. 3

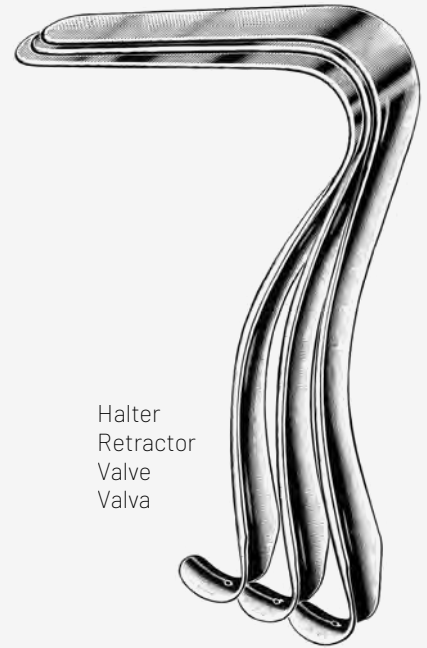

Halter
 Retractor
 Valve
 Valva

KRISTELLER	
32-1142.01	Fig. 1
32-1142.02	Fig. 2
32-1142.03	Fig. 3



Satz
 Set
 Jeu
 Juego

KRISTELLER	
32-1150.00	



Spekulum
 Speculum
 Spéculum
 Espéculo

KRISTELLER	
32-1151.00	



Halter
 Retractor
 Valve
 Valva

KRISTELLER	
32-1152.00	



Satz
 Set
 Jeu
 Juego

KALLMORGEN		
32-1160.01	Fig. 1	
32-1160.02	Fig. 2	



Spekulum
 Speculum
 Spéculum
 Espéculo

KALLMORGEN		
32-1161.01	Fig. 1	
32-1161.02	Fig. 2	



Halter
 Retractor
 Valve
 Valva

KALLMORGEN		
32-1162.01	Fig. 1	
32-1162.02	Fig. 2	



JACKSON		
32-1171.01	Fig. 1	75 x 38 mm
32-1171.02	Fig. 2	90 x 38 mm
32-1171.03	Fig. 3	100 x 38 mm



SIMS		
32-1181.01	Fig. 1	
32-1181.02	Fig. 2	
32-1181.03	Fig. 3	

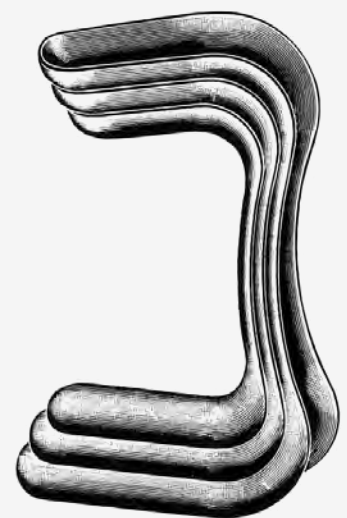

SIMS		
32-1191.00	Set	
32-1191.01	Fig. 1	
32-1191.02	Fig. 2	
32-1191.03	Fig. 3	

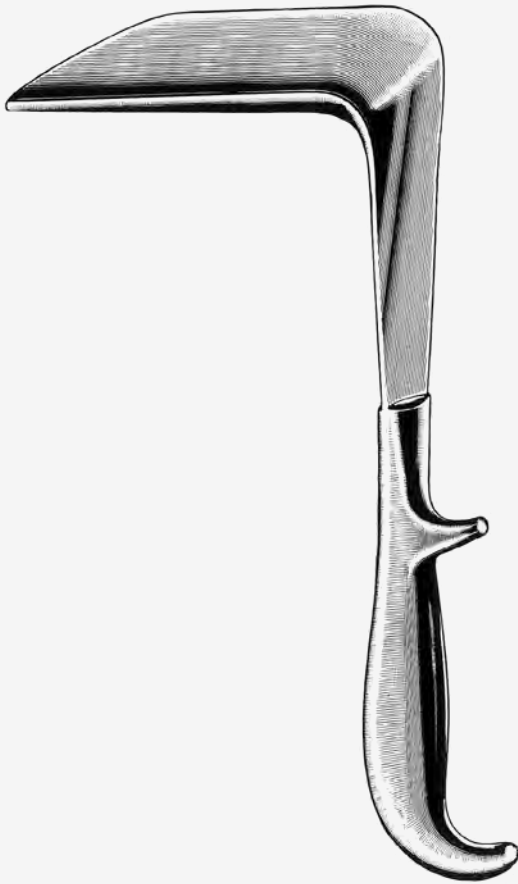

DOYEN

32-1201.01	Fig. 1	55 x 35 mm
32-1201.02	Fig. 2	85 x 35 mm
32-1201.03	Fig. 3	115 x 35 mm
32-1203.01	Fig. 1	55 x 45 mm
32-1203.02	Fig. 2	85 x 45 mm
32-1203.03	Fig. 3	115 x 45 mm
32-1203.04	Fig. 4	160 x 45 mm
32-1205.01	Fig. 1	55 x 60 mm
32-1205.02	Fig. 2	85 x 60 mm
32-1205.03	Fig. 3	115 x 60 mm
32-1205.04	Fig. 4	160 x 60 mm



mit abnehmbarem Gewicht
 with detachable weight
 avec poids démontable
 con peso desmontable

AUVARD
32-1507.00



mit festem Gewicht
 with fixed weight
 avec poids fixe
 con peso fijo

AUVARD
32-1509.00



BREISKY

32-1510.20	100 x 20 mm
32-1510.25	100 x 25 mm
32-1510.30	100 x 30 mm
32-1510.35	100 x 35 mm
32-1510.40	100 x 40 mm
32-1513.20	130 x 20 mm
32-1513.25	130 x 25 mm
32-1513.30	130 x 30 mm
32-1513.35	130 x 35 mm
32-1513.40	130 x 40 mm
32-1515.40	155 x 40 mm



LANDAU

32-1519.28	100 x 28 mm
32-1519.38	100 x 38 mm



KOGAN

32-1560.24
24 cm, 9 1/2"



FRIEDMANN

32-1551.10
10 cm, 4"

32

Uterus-Dilatatoren
Uterine Dilators
 Dilatateurs utérins
 Dilatadores uterinos



32-1610.01	1 mm	32-1610.16	16 mm
32-1610.02	2 mm	32-1610.17	17 mm
32-1610.03	3 mm	32-1610.18	18 mm
32-1610.04	4 mm	32-1610.19	19 mm
32-1610.05	5 mm	32-1610.20	20 mm
32-1610.06	6 mm	32-1610.21	21 mm
32-1610.07	7 mm	32-1610.22	22 mm
32-1610.08	8 mm	32-1610.23	23 mm
32-1610.09	9 mm	32-1610.24	24 mm
32-1610.10	10 mm	32-1610.25	25 mm
32-1610.11	11 mm	32-1610.26	26 mm
32-1610.12	12 mm	32-1610.27	27 mm
32-1610.13	13 mm	32-1610.28	28 mm
32-1610.14	14 mm	32-1610.29	29 mm
32-1610.15	15 mm	32-1610.30	30 mm

HEGAR

HEGAR

32-1604.14 4 - 17 mm

32-1604.26 1 - 26 mm



32-1615.01	1,5 mm
32-1615.02	2,5 mm
32-1615.03	3,5 mm
32-1615.04	4,5 mm
32-1615.05	5,5 mm
32-1615.06	6,5 mm
32-1615.07	7,5 mm
32-1615.08	8,5 mm
32-1615.09	9,5 mm
32-1615.10	10,5 mm
32-1615.11	11,5 mm
32-1615.12	12,5 mm
32-1615.13	13,5 mm
32-1615.14	14,5 mm
32-1615.15	15,5 mm
32-1615.16	16,5 mm

HEGAR



HEGAR

32-1605.14 4 - 17 mm



HEGAR

32-1606.14 4 - 17 mm

32-1606.26 1 - 26 mm



HEGAR

32-1620.01	1/2 mm
32-1620.03	3/4 mm
32-1620.05	5/6 mm
32-1620.07	7/8 mm
32-1620.09	9/10 mm
32-1620.11	11/12 mm
32-1620.13	13/14 mm
32-1620.15	15/16 mm
32-1620.17	17/18 mm
32-1620.19	19/20 mm
32-1620.21	21/22 mm
32-1620.23	23/24 mm
32-1620.25	25/26 mm

HEGAR	
32-1624.08	3/4 - 17/18 mm
32-1624.13	1/2 - 25/26 mm

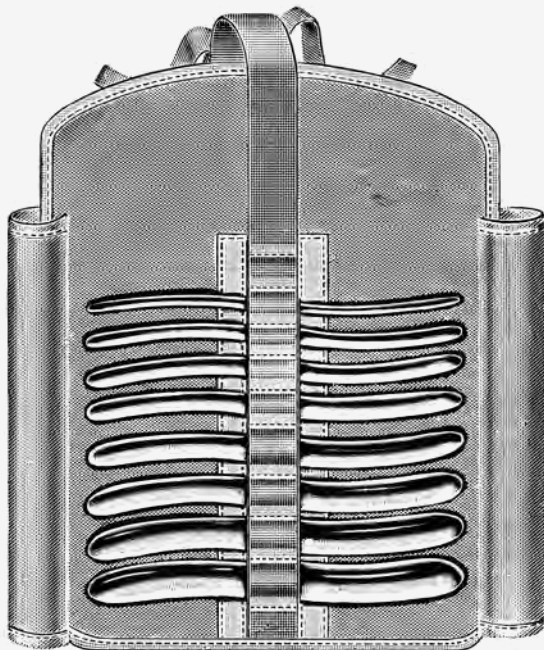

HEGAR

32-1625.08	3/4 - 17/18 mm
-------------------	----------------



HEGAR

32-1626.08	3/4 - 17/18 mm
32-1626.13	1/2 - 25/26 mm



HANK
32-1635.06
 4,5/5 - 9,5/10 mm

HANK	
32-1630.10	4,5/5 mm
32-1630.12	5,5/6 mm
32-1630.14	6,5/7 mm
32-1630.16	7,5/8 mm
32-1630.18	8,5/9 mm
32-1630.20	9,5/10 mm

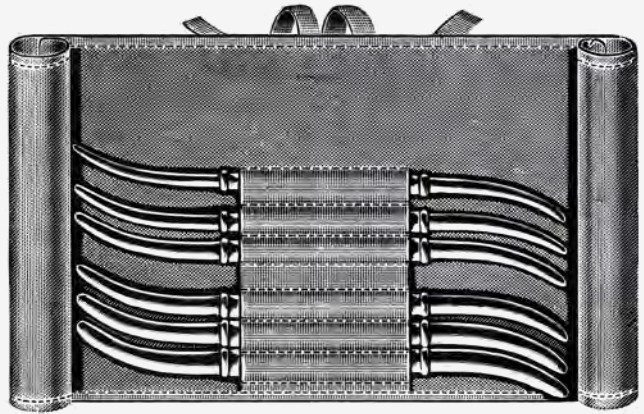

HANK
32-1636.08



GOODELL
32-1641.34
 34 cm, 13 1/4"



WYLIE
32-1643.29
 29 cm, 11 1/4"

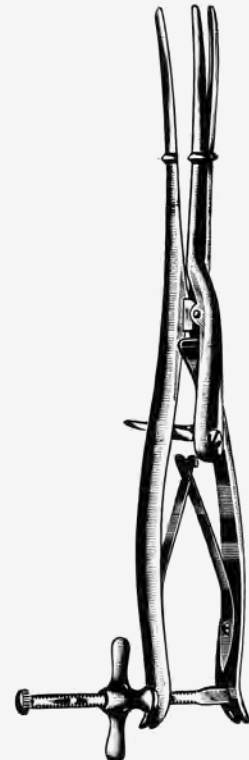

SIMS
32-1645.29
 29 cm, 11 1/4"



SCHROEDER

32-1702.25

25 cm, 10"



BRAUN

32-1704.25

25 cm, 10"



SKENE

32-1705.24

24 cm, 9 1/2"



DUPLAY

32-1707.28

28 cm, 11"



STAUDE-MOORE

32-1708.17

17 cm, 6 3/4"



BARRETT

32-1710.18

18 cm, 7"

32

Hakenzangen

Tenaculum Forceps

Pinces pour abaissement du col de l'utérus

Pinzas para coger el cuello del útero



JARCHO

32-1712.20

20 cm, 8"



SCHROEDER

32-1714.24

24 cm, 9 1/2"



SCHROEDER

32-1715.24

24 cm, 9 1/2"



MUSEUX

24 cm, 9 1/2"



32-1724.06

6 mm



32-1724.08

8 mm



32-1724.10

10 mm

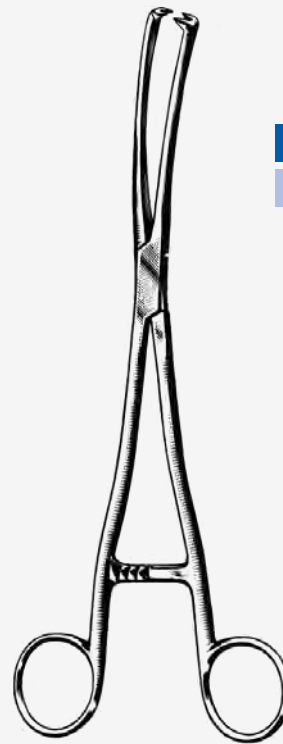

MUSEUX

24 cm, 9 1/2"



32-1725.06

6 mm



32-1725.08

8 mm



32-1725.10

10 mm



TEALE
32-1731.23
 23 cm, 9"



JACOBS
32-1732.21
 21 cm, 8 1/4"



JACOBS
32-1733.21
 21 cm, 8 1/4"

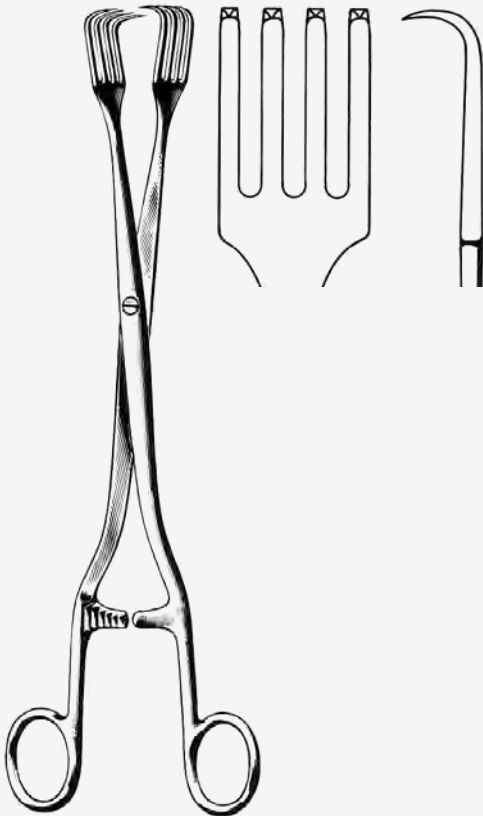

PRATT
32-1736.28
 28 cm, 11"



IOWA
32-1739.26
 26 cm, 10 1/4"



BEACHAM
32-1759.26
 26 cm, 10 1/4"

Amniotom
 Amniotome
 Amniotome
 Amniótomo

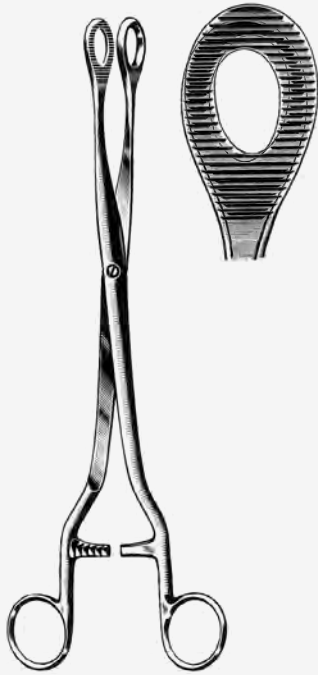

NOTO
 32-1740.27
 27 cm, 10 1/2"



DOYEN
 32-1742.20
 20 cm, 8"



KELLY
 32-1743.32
 32 cm, 12 3/4"



DARTIGUES
 32-1745.27
 27 cm, 10 1/2"



SOMER
 32-1747.23
 23 cm, 9"

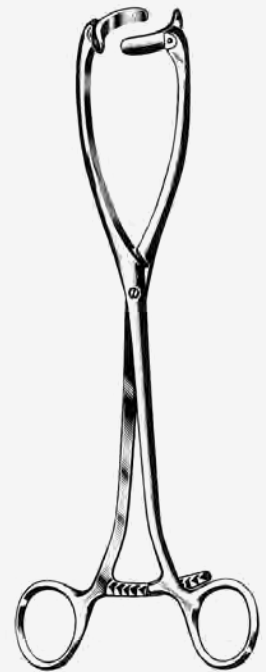

COLLIN
 32-1749.25
 25 cm, 10"



BRAUN
 32-1765.28
 28 cm, 11"

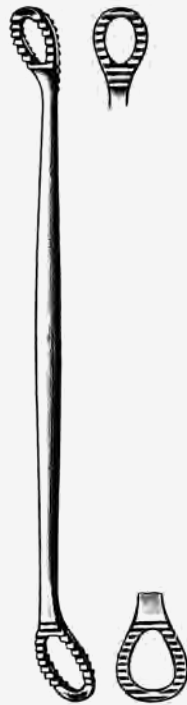

SIMS
 32-1767.26
 26 cm, 10 1/4"



COLLIN
 32-1784.28
 28 cm, 11"



starr
 rigid
 rigide
 rígida

SIMS
 32-1780.32
 32 cm, 12 3/4"



biegsam
 malleable
 malléable
 maleable

SIMS
 32-1781.32
 32 cm, 12 3/4"



starr
 rigid
 rigide
 rígida

MARTIN
 32-1782.32
 32 cm, 12 3/4"



biegsam
 malleable
 malléable
 maleable

MARTIN
 32-1783.32
 32 cm, 12 3/4"



RANDALL

32-1790.04

24 cm, 9 1/2"



NOVAK

32-1792.01

1 mm

32-1792.02

2 mm

32-1792.03

3 mm

32-1792.04

4 mm

24 cm, 9 1/2"



KEVORKIAN

32-1794.12

1,2 mm

32-1794.40

4,0 mm

30 cm, 12"

4,0 mm



KEVORKIAN

32-1796.40

30 cm, 12"



FAURE
32-1801.21
 21 cm, 8 1/4"



SCHUBERT
32-1804.21 21 cm, 8 1/4"
32-1804.28 28 cm, 11"



SCHUBERT
32-1805.26
 26 cm, 10 1/4"



THOMS-GAYLOR
32-1806.24
 24 cm, 9 1/2"



GELLHORN
32-1809.23
 23 cm, 9"



VAN DOREN
32-1811.25
 25 cm, 10"

32

Biopsiezangen
Biopsy Specimen Forceps
Pinces à biopsie
Pinzas sacabocados para biopsia

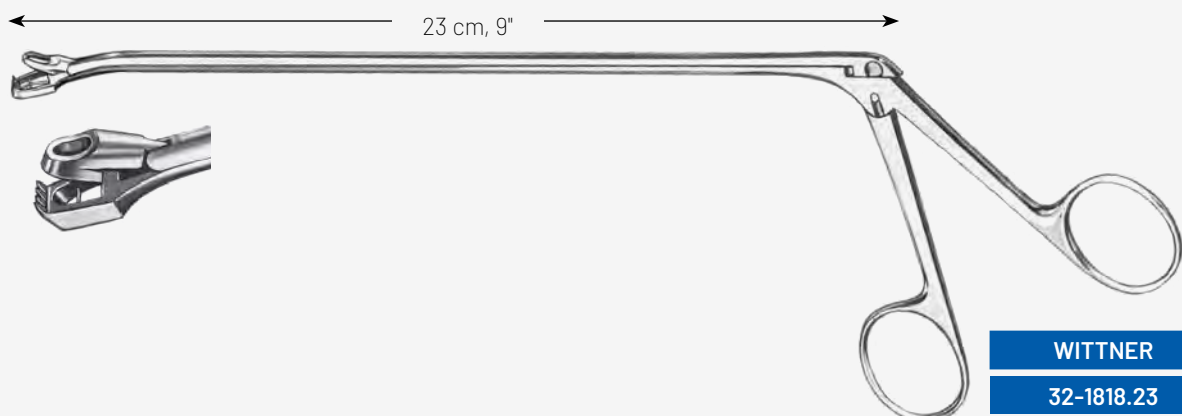
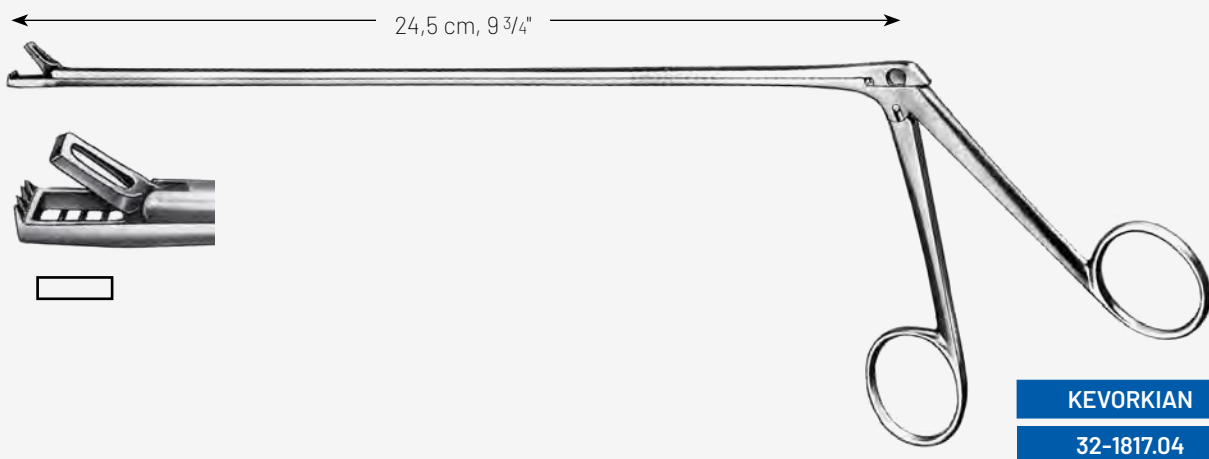
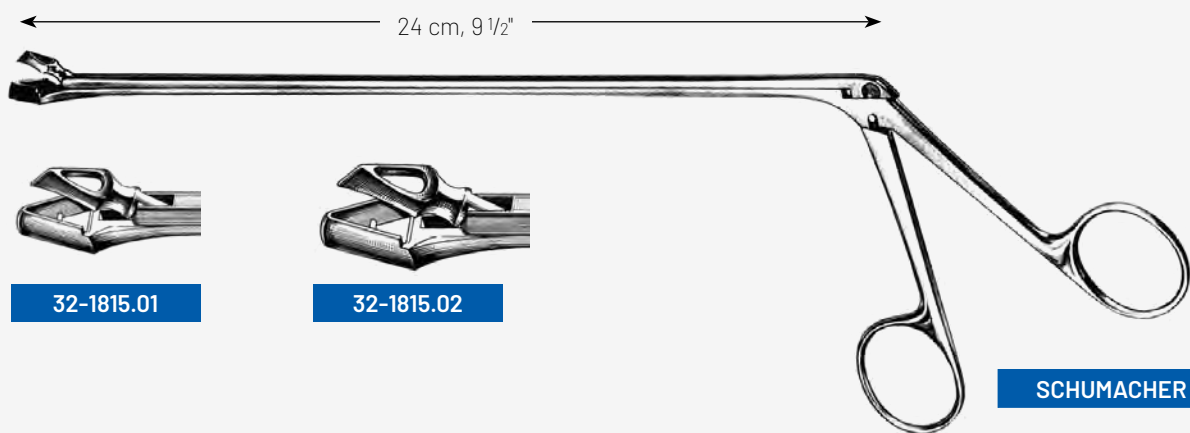
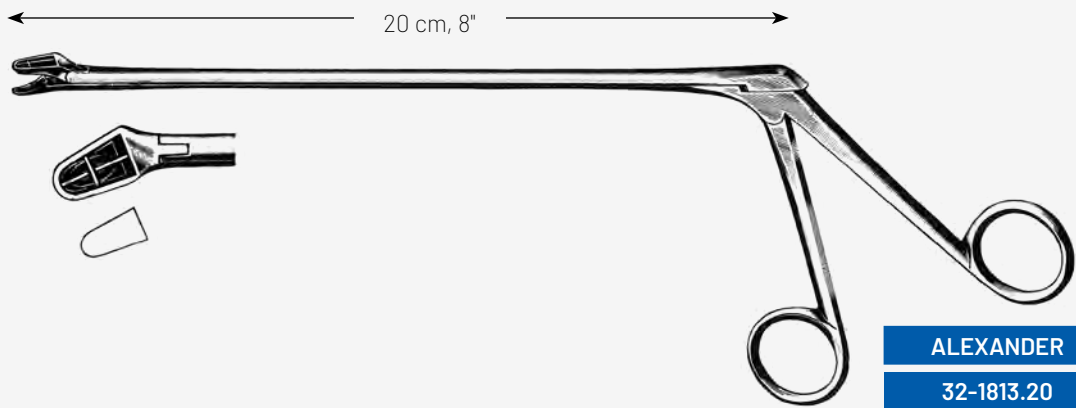

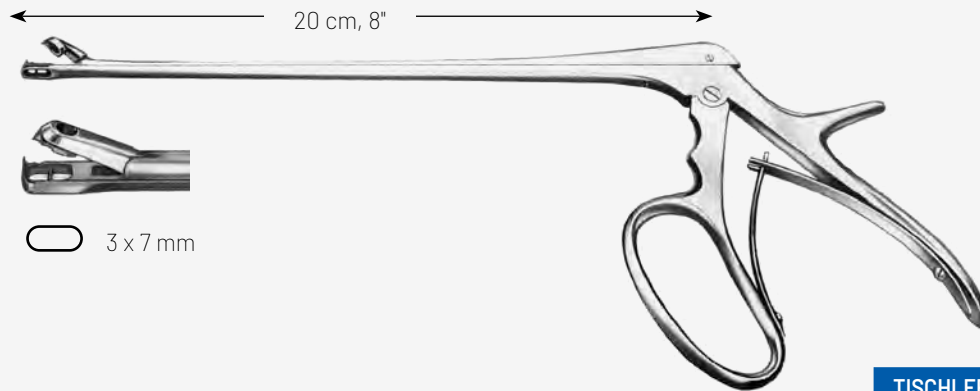

TISCHLER-MORGAN

32-1821.01

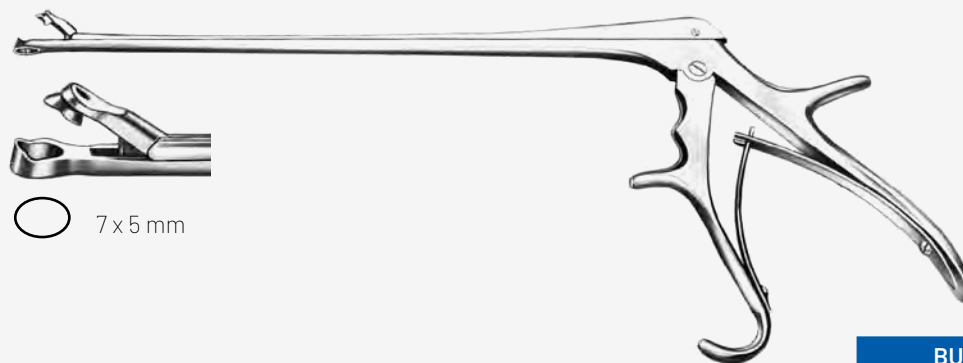

BURKE

32-1822.00

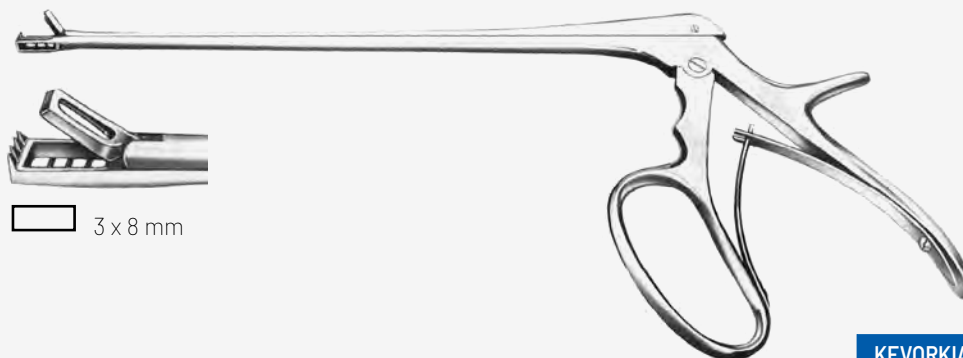

KEVORKIAN-PACIFIC

32-1825.04

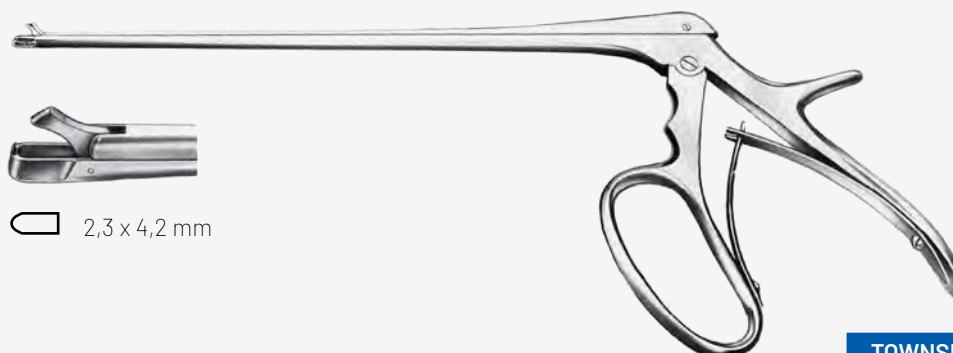

TOWNSEND-MINI

32-1826.00



TOWNSEND-TISCHLER

Instrument komplett
 Instrument complete
 Instrument complet
 Instrumento completo

32-1824.01

Aufsatz allein
 Tip only
 Embout seul
 Punta sola

32-1824.11



TOWNSEND

Instrument komplett
 Instrument complete
 Instrument complet
 Instrumento completo

32-1824.02

Aufsatz allein
 Tip only
 Embout seul
 Punta sola

32-1824.12



TOWNSEND

Instrument komplett
 Instrument complete
 Instrument complet
 Instrumento completo

32-1824.03

Aufsatz allein
 Tip only
 Embout seul
 Punta sola

32-1824.13



TOWNSEND-KEVORKIAN

Instrument komplett
 Instrument complete
 Instrument complet
 Instrumento completo

32-1824.04

Aufsatz allein
 Tip only
 Embout seul
 Punta sola

32-1824.14

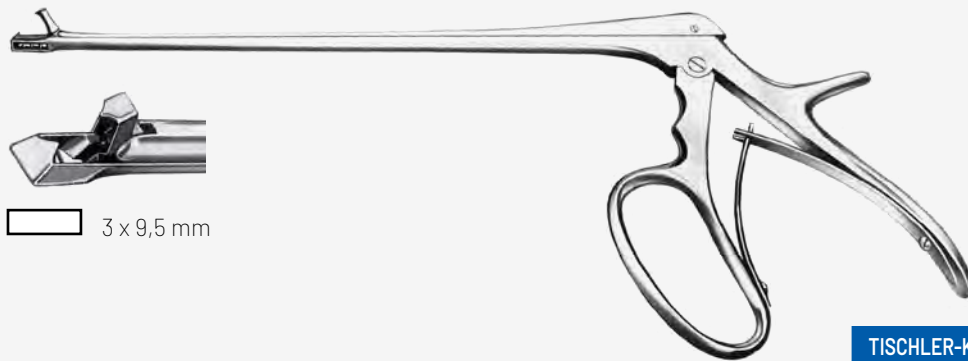

 3 x 9,5 mm

TISCHLER-KEVORKIAN

32-1827.00

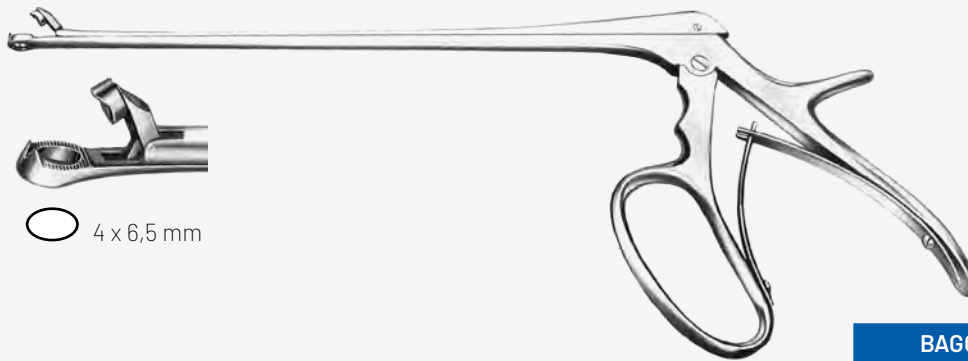

 4 x 6,5 mm

BAGGISH

32-1828.00



 4 x 8 mm

EPPENDORFER

32-1830.00



EPPENDORFER



TISCHLER-MORGAN

Instrument komplett
 Instrument complete
 Instrument complet
 Instrumento completo

32-1832.01

Aufsatz allein
 Tip only
 Embout seul
 Punta sola

32-1832.11



EPPENDORFER

Instrument komplett
 Instrument complete
 Instrument complet
 Instrumento completo

32-1832.02

Aufsatz allein
 Tip only
 Embout seul
 Punta sola

32-1832.12



EPPENDORFER

Instrument komplett
 Instrument complete
 Instrument complet
 Instrumento completo

32-1832.03

Aufsatz allein
 Tip only
 Embout seul
 Punta sola

32-1832.13



KEVORKIAN

Instrument komplett
 Instrument complete
 Instrument complet
 Instrumento completo

32-1832.04

Aufsatz allein
 Tip only
 Embout seul
 Punta sola

32-1832.14



DOYEN
 32-1841.17
 17 cm, 6 3/4"

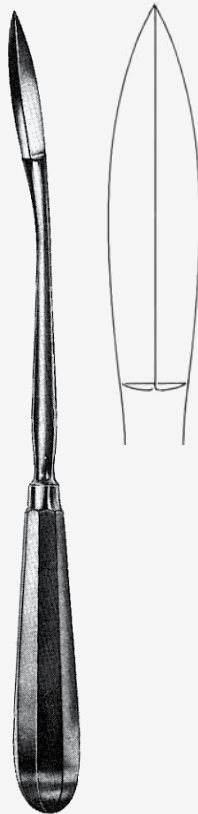

SEGOND
 32-1843.27
 27 cm, 10 1/2"



EMMET
 22 cm, 8 1/2"

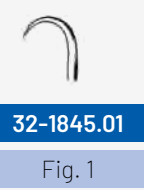

32-1845.01
 Fig. 1



32-1845.02
 Fig. 2



32-1845.03
 Fig. 3

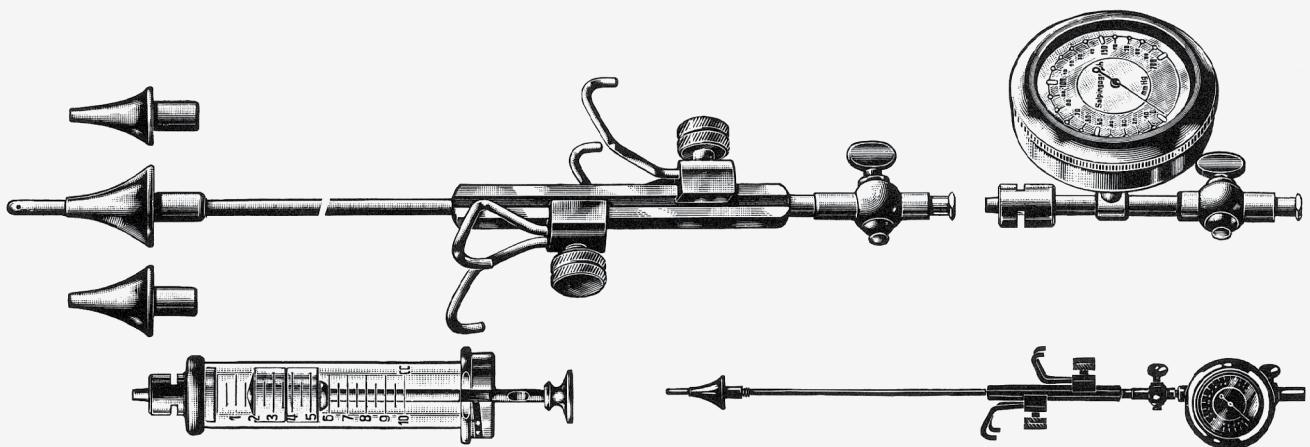

SCHULTZE
 32-1850.00

Salpingograph
 Salpingograph
 Salpingographe
 Salpingógrafo



32-1902.01

Fig. 1



32-1902.02

Fig. 2



32-1902.03

Fig. 3



32-1902.04

Fig. 4



32-1902.05

Fig. 5



32-1902.06

Fig. 6



SIMON

25 cm, 10"



BLAKE

32-1904.27

27 cm, 10 1/2"

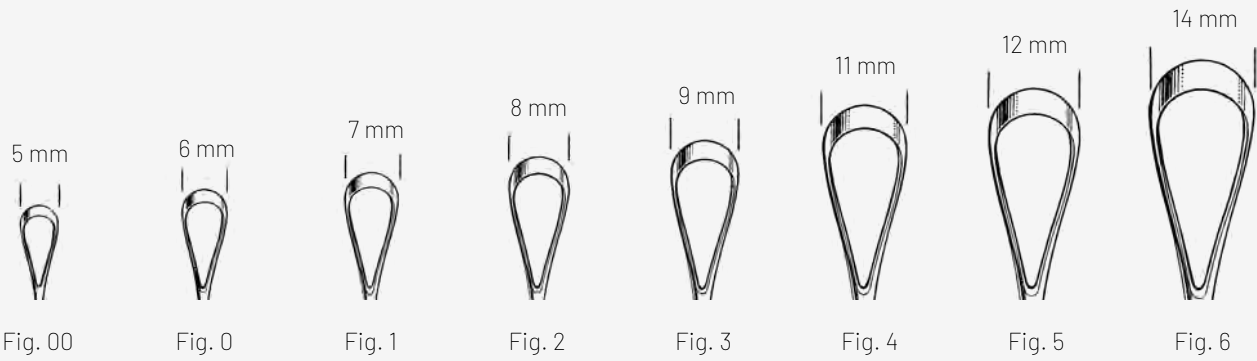

scharf, fest
 sharp, rigid
 tranchantes, rigides
 cortantes, rígidas

stumpf, fest
 blunt, rigid
 mouses, rigides
 romas, rígidas

scharf, biegsam
 sharp, malleable
 tranchantes, malléables
 cortantes, maleables

stumpf, biegsam
 blunt, malleable
 mouses, malléables
 romas, maleables

Fig. 00	32-1912.05	32-1914.05	32-1913.05	32-1915.05
Fig. 0	32-1912.06	32-1914.06	32-1913.06	32-1915.06
Fig. 1	32-1912.07	32-1914.07	32-1913.07	32-1915.07
Fig. 2	32-1912.08	32-1914.08	32-1913.08	32-1915.08
Fig. 3	32-1912.09	32-1914.09	32-1913.09	32-1915.09
Fig. 4	32-1912.11	32-1914.11	32-1913.11	32-1915.11
Fig. 5	32-1912.12	32-1914.12	32-1913.12	32-1915.12
Fig. 6	32-1912.14	32-1914.14	32-1913.14	32-1915.14

SIMS

28 cm, 11"

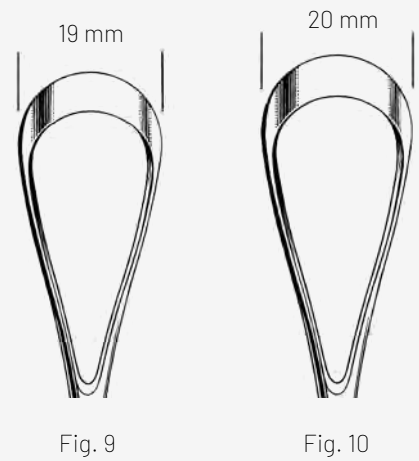
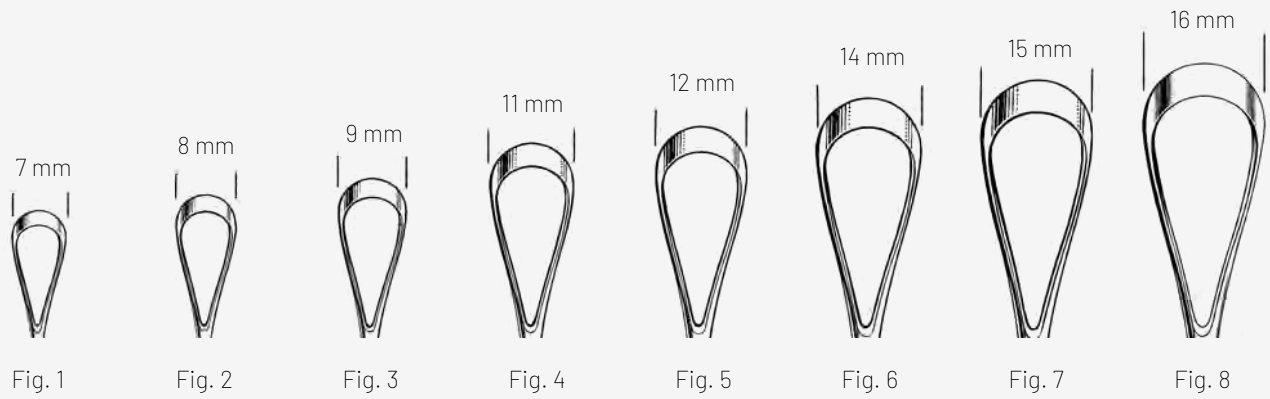

scharf, fest
 sharp, rigid
 tranchantes, rigides
 cortantes, rígidas

stumpf, fest
 blunt, rigid
 mouses, rigides
 romas, rígidas

scharf, biegsam
 sharp, malleable
 tranchantes, malléables
 cortantes, maleables

stumpf, biegsam
 blunt, malleable
 mouses, malléables
 romas, maleables

Fig. 1	32-1922.07	32-1924.07	32-1925.07	32-1927.07
Fig. 2	32-1922.08	32-1924.08	32-1925.08	32-1927.08
Fig. 3	32-1922.09	32-1924.09	32-1925.09	32-1927.09
Fig. 4	32-1922.11	32-1924.11	32-1925.11	32-1927.11
Fig. 5	32-1922.12	32-1924.12	32-1925.12	32-1927.12
Fig. 6	32-1922.14	32-1924.14	32-1925.14	32-1927.14
Fig. 7	32-1922.15	32-1924.15	32-1925.15	32-1927.15
Fig. 8	32-1922.16	32-1924.16	32-1925.16	32-1927.16
Fig. 9	32-1922.19	32-1924.19	32-1925.19	32-1927.19
Fig. 10	32-1922.20	32-1924.20	32-1925.20	32-1927.20

RECAMIER

31 cm, 12 1/2"

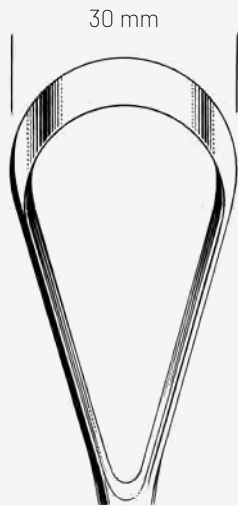

30 mm

Fig. 14

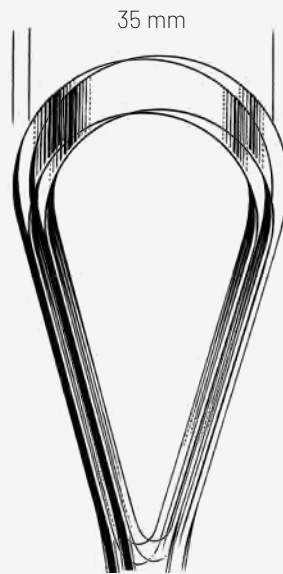

35 mm

Fig. 15



40 mm

Fig. 16



scharf, fest
 sharp, rigid
 tranchantes, rigides
 cortantes, rígidas

stumpf, fest
 blunt, rigid
 mouses, rigides
 romas, rígidas

scharf, biegsam
 sharp, malleable
 tranchantes, malléables
 cortantes, maleables

stumpf, biegsam
 blunt, malleable
 mouses, malléables
 romas, maleables

Fig. 14	32-1932.30	32-1934.30	32-1933.30	32-1935.30
Fig. 15	32-1932.35	32-1934.35	32-1933.35	32-1935.35
Fig. 16	32-1932.40	32-1934.40	32-1933.40	32-1935.40

BUMM

28 cm, 11"

Chapter 33

Table of Contents

Geburtshilfe / p. 484 - 492

Obstetrics / p. 484 - 492

Obstétrique / p. 484 - 492

Obstetricia / p. 484 - 492





33

Geburtszangen
Obstetrical Forceps
 Forceps
 Fórceps obstétricos



WRIGLEY

33-1110.23

23 cm, 9"



SIMPSON

33-1112.30

30 cm, 12"

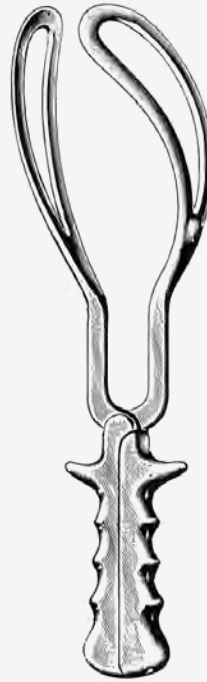

SIMPSON-BRAUN

33-1115.33

33 cm, 13"

33-1115.36

36 cm, 14"



DE LEE

33-1117.30

30 cm, 10 1/2"



DE LEE

33-1118.36

36 cm, 14"

33-1118.39

39 cm, 15 1/2"



ELLIOT

33-1125.32

32 cm, 12 3/4"

33-1125.38

38 cm, 15"

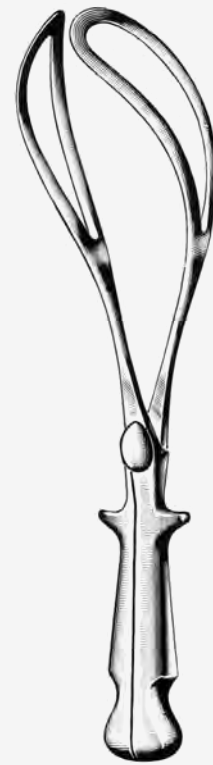

NAEGELE

33-1129.36

36 cm, 14"

33-1129.40

40 cm, 15 3/4"



KIELLAND

33-1120.41

41 cm, 16 1/4"



LUIKART

33-1135.40

40 cm, 15 3/4"



KILLAND-LUIKART

33-1137.40

40 cm, 15 3/4"



SIMPSON-LUIKART

33-1145.36

36 cm, 14"



McLEAN-TUCKER-LUIKART

33-1149.40

40 cm, 15 3/4"



McLEAN-TUCKER

33-1151.39

39 cm, 15 1/2"

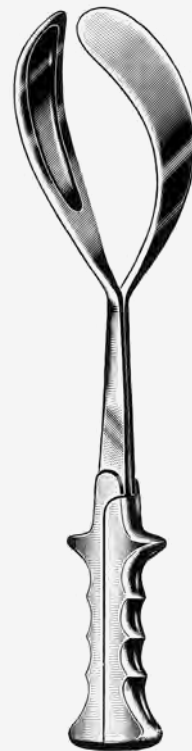

McLEAN-LUIKART

33-1153.39

39 cm, 15 1/2"



McLEAN

33-1155.36

36 cm, 14"

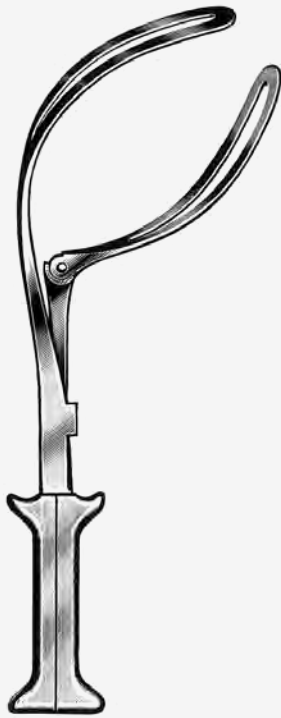

BARTON

33-1157.36

36 cm, 14"



BARTON

33-1158.17

17 cm, 6 3/4"



BOERMA

33-1161.29

29 cm, 11 1/4"



PIPER

33-1165.44

44 cm, 17 1/2"



PIPER

33-1167.40

40 cm, 15 3/4"



DEWEY

33-1170.37

37 cm, 14 1/4"

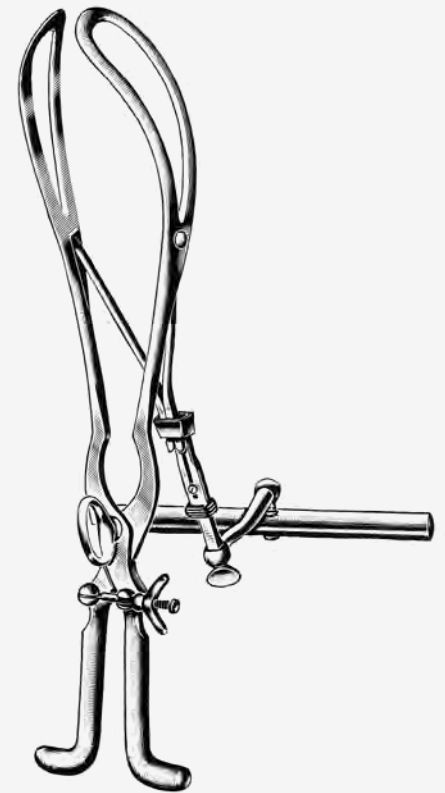

TARNIER

33-1172.40

40 cm, 15 3/4"

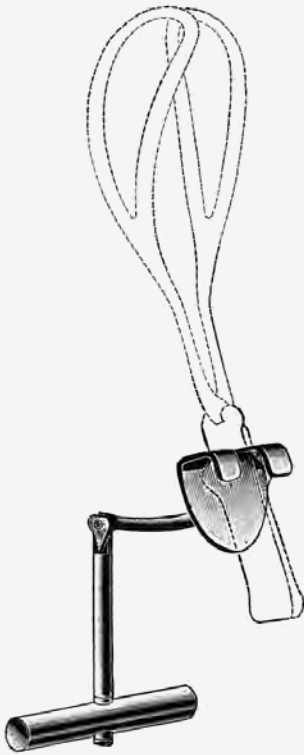

BILL

33-1180.00

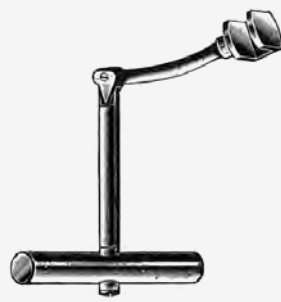

LUIKART-BILL

33-1181.21

21 cm, 8"



SMELLIE

33-1191.33

33 cm, 13"



SELLHEIM

33-1249.28

28 cm, 11"

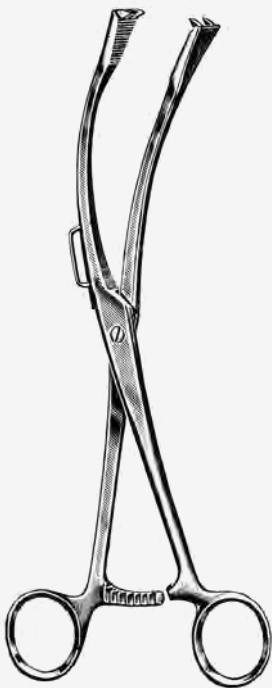

GAUSS

33-1193.27

27 cm, 10 1/2"

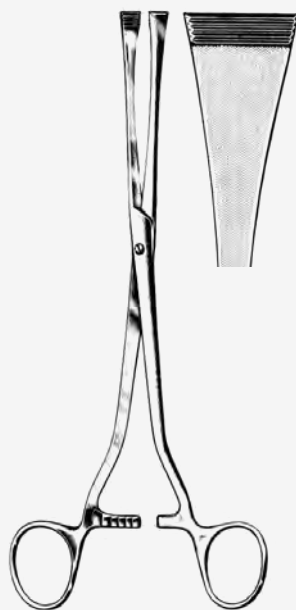

GREEN-ARMYTAGE

33-1194.21

21 cm, 8"



COLLIN

33-1197.09

9 cm, 3 1/2"

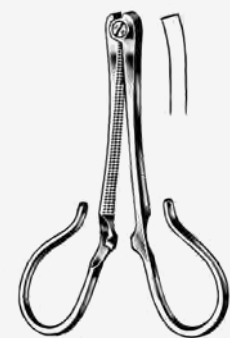

KANE

33-1199.09

8,5 cm, 3 1/4"



MARTIN
 33-1201.34
 34 cm, 13 1/4"

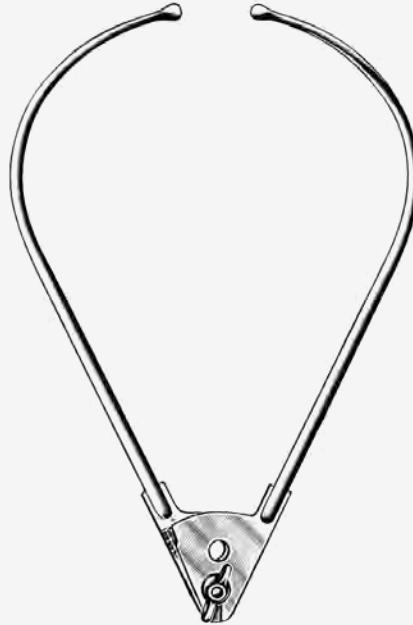

COLLIER
 33-1203.30
 30 cm, 12"



COLLIN
 33-1205.35
 35 cm, 13 3/4"

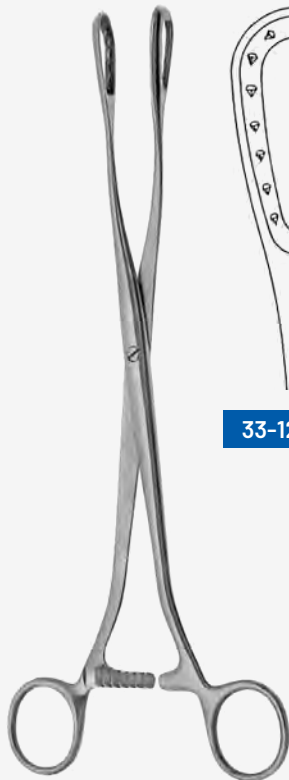

SAENGER
 27 cm, 10 1/2"

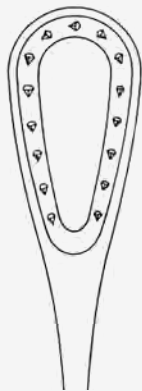

33-1232.27

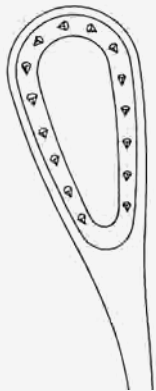

33-1233.27



WINTER
 28 cm, 11"



33-1234.01
 Fig. 1



33-1234.02
 Fig. 2

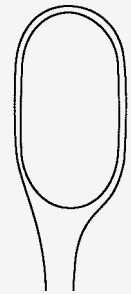

33-1234.03
 Fig. 3



33-1235.01
 Fig. 1



33-1235.02
 Fig. 2



33-1235.03
 Fig. 3

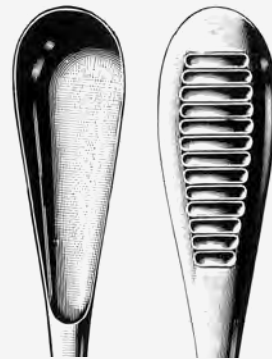

33-1244.14

14,5 mm

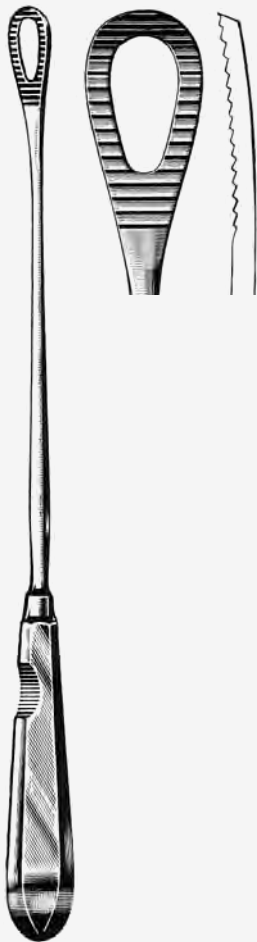

PESTALOZZA

33-1242.30

30 cm, 12"



CUZZI

30 cm, 12"



33-1244.18

18 mm



33-1244.21

21 mm



WALLICH

33-1246.42

42 cm, 17"

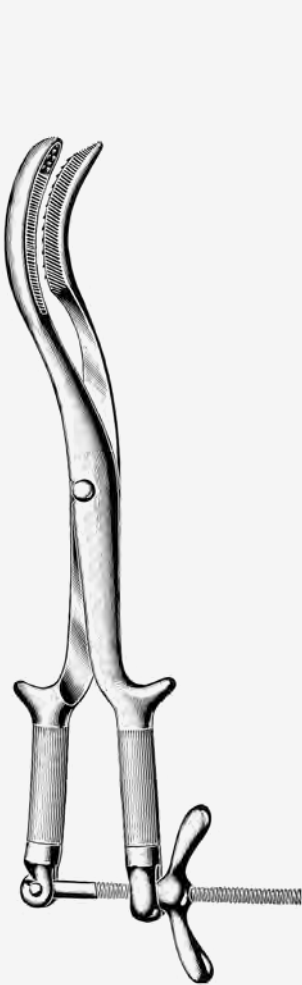
**BRAUN**

33-1250.42

42 cm, 17"

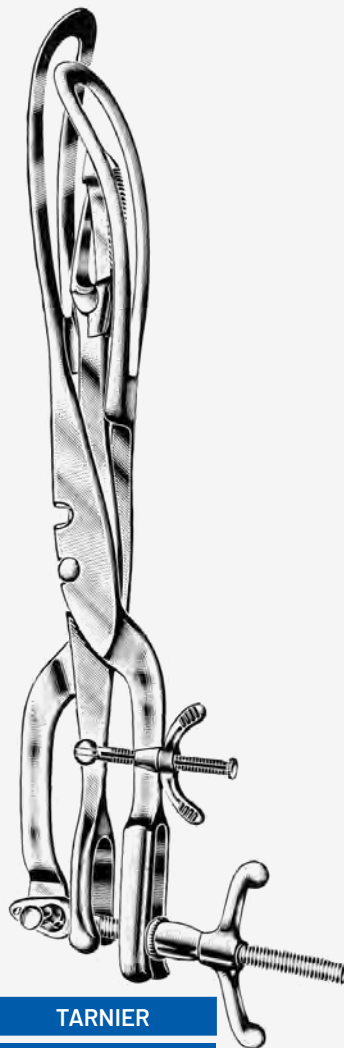
**TARNIER**

33-1254.46

46 cm, 18"

**SMELLIE**

33-1256.25

25 cm, 10"

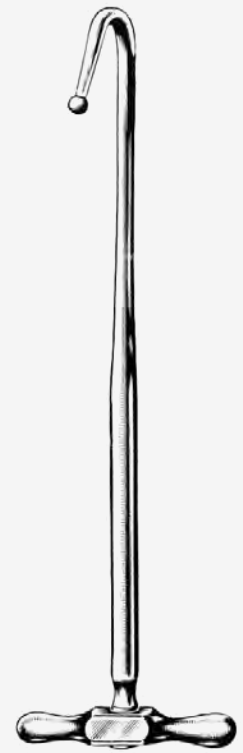
**BRAUN**

33-1259.30

30 cm, 12"

Chapter 34

Table of Contents

Dermatologie / p. 494 - 498

Dermatology / p. 494 - 498

Dermatologie / p. 494 - 498

Dermatología / p. 494 - 498







KILNER

34-1230.15

15 cm, 5 3/4"



SCHAMBERG

34-1241.10

10 cm, 4"



UNNA

34-1243.14

14 cm, 5 1/2"



UNNA

34-1245.14

14 cm, 5 1/2"



WALTON

34-1248.14

14 cm, 5 1/2"



SAALFELD

34-1251.10

10 cm, 4"



FOX



34-1258.03

3 mm



34-1258.04

4 mm



34-1258.05

5 mm



34-1258.06

6 mm



PIFFARD



34-1260.03

Fig. 1



34-1260.04

Fig. 2



34-1260.05

Fig. 3

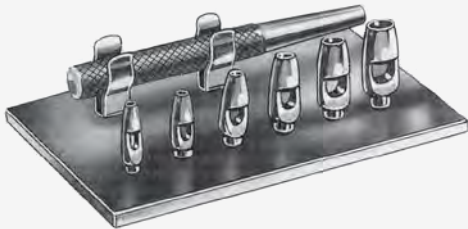

KEYES

34-1268.00

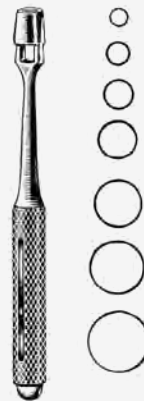

KEYES

34-1270.02	2 mm
34-1270.03	3 mm
34-1270.04	4 mm
34-1270.05	5 mm
34-1270.06	6 mm
34-1270.07	7 mm
34-1270.08	8 mm



34-1310.10



34-1314.10

10 cm, 4"



34-1315.10

10 cm, 4"



34-1356.10 10 cm, 4"

34-1356.12 12 cm, 4 3/4"



34-1348.10

10 cm, 4"



34-1349.10

10 cm, 4"



CREDO

34-1370.00

Ersatzklingen, 10 Stück
 Spare Blades, 10 pieces
 Lames de rechange, 10 pièces
 Hojas de repuseto, 10 piezas

CREDO

34-1369.14

14,5 cm, 5 1/2"



34-1317.14

14 cm, 5 1/2"



34-1320.14

14 cm, 5 1/2"



TURNBULL

34-1323.11

11,5 cm, 4 1/2"

34-1323.13

13,5 cm, 5 1/4"



34-1330.13

13 cm, 5"



34-1335.11

11 cm, 4 1/4"



34-1343.10

10,5 cm, 4"

Chapter 35

Table of Contents

Sterilisierbehälter, Instrumentenschalen, Lösungsschalen, Nadeldosen / **p. 500 - 506**

Trays, Instrument Cases, Solution Bowls, Needle Cases / **p. 500 - 506**

Boîtes et plateaux à instruments, tambours à stérilisation / Boîtes à aiguilles / **p. 500 - 506**

Tambores para esterilización, bandejas, cajas para agujas / **p. 500 - 506**







SAUERBRUCH

35-1120.21

210 x 125 x 17 mm



35-1124.00

150 x 95 x 13 mm



35-1122.65

65 x 15 mm



35-1123.65

65 x 15 mm



35-1251.10

100 x 20 mm



35-1130.18	180 x 80 x 40 mm
35-1130.20	200 x 100 x 60 mm
35-1130.22	220 x 120 x 40 mm
35-1130.25	250 x 120 x 40 mm
35-1130.30	300 x 125 x 40 mm
35-1130.32	320 x 150 x 40 mm
35-1130.40	400 x 60 x 75 mm
35-1130.50	500 x 200 x 120 mm



35-1144.01	45 x 25 mm
35-1144.02	50 x 28 mm
35-1144.03	55 x 30 mm
35-1144.04	60 x 32 mm
35-1144.05	70 x 36 mm
35-1144.06	80 x 40 mm
35-1144.07	100 x 50 mm



35-1140.04	40 mm
35-1140.06	60 mm
35-1140.08	80 mm
35-1140.10	100 mm
35-1140.12	120 mm
35-1140.15	150 mm

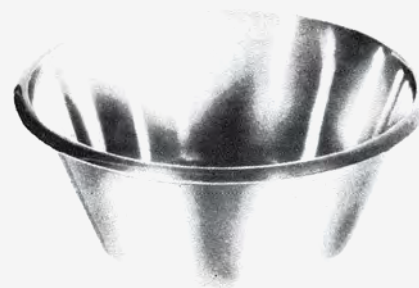

35-1143.16	0,75 l	165 x 60 mm
35-1143.17	1,0 l	175 x 70 mm
35-1143.22	2,0 l	220 x 80 mm
35-1143.23	2,5 l	225 x 90 mm
35-1143.24	3,0 l	240 x 110 mm
35-1143.25	4,0 l	255 x 115 mm
35-1143.27	5,0 l	275 x 115 mm
35-1143.29	6,0 l	290 x 125 mm
35-1143.31	6,0 l	310 x 120 mm
35-1143.34	8,5 l	345 x 125 mm
35-1143.38	11,0 l	380 x 130 mm
35-1143.41	14,0 l	415 x 140 mm



35-1150.02	0,25 l
35-1150.05	0,50 l
35-1150.10	1,00 l
35-1150.20	2,00 l

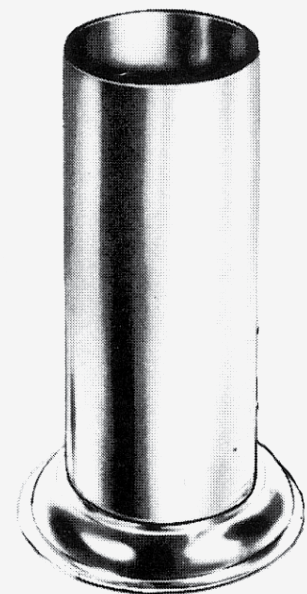

35-1252.01	30 x 90 mm
35-1252.02	50 x 100 mm
35-1252.03	50 x 130 mm
35-1252.04	50 x 175 mm
35-1252.05	75 x 100 mm
35-1252.06	75 x 130 mm
35-1252.07	75 x 175 mm
35-1252.08	100 x 175 mm
35-1252.09	100 x 200 mm



35-1149.17	170 x 100 x 30 mm
35-1149.20	200 x 120 x 35 mm
35-1149.25	250 x 140 x 40 mm
35-1149.27	275 x 150 x 50 mm
35-1149.30	300 x 160 x 50 mm
35-1149.40	400 x 200 x 60 mm



35-1253.21	210 x 160 x 10 mm
35-1253.24	240 x 180 x 10 mm
35-1253.29	290 x 190 x 10 mm
35-1253.30	310 x 150 x 10 mm
35-1253.32	300 x 200 x 20 mm
35-1253.33	300 x 245 x 16 mm
35-1253.35	350 x 240 x 10 mm
35-1253.38	385 x 265 x 10 mm
35-1253.40	400 x 270 x 20 mm
35-1253.42	420 x 280 x 10 mm
35-1253.43	430 x 298 x 16 mm
35-1253.49	485 x 320 x 16 mm
35-1253.51	510 x 380 x 30 mm
35-1253.59	590 x 380 x 30 mm

35-1254.20 / D	200 x 150 x 25 mm
35-1254.22 / D	230 x 155 x 30 mm
35-1254.28 / D	300 x 175 x 30 mm
35-1254.30 / D	300 x 175 x 40 mm
35-1254.32 / D	300 x 200 x 50 mm
35-1254.35 / D	350 x 220 x 40 mm
35-1254.37 / D	400 x 300 x 50 mm
35-1254.42 / D	450 x 350 x 50 mm



Mit oder ohne Deckel erhältlich / available with or without lid.
 Bei Bestellung mit Deckel- bitte „D“ hinter der Nummer angeben.
 Please add a D behind the item code.



35-2010.26	260 x 260 x 50 mm
35-2010.48	480 x 260 x 50 mm



35-1256.22	220 x 170 x 50 mm
35-1256.26	300 x 175 x 30 mm
35-1256.28	300 x 175 x 40 mm
35-1256.32	300 x 200 x 50 mm
35-1256.35	350 x 240 x 36 mm
35-1256.37	400 x 300 x 50 mm
35-1256.42	450 x 350 x 50 mm



SCHIMMELBUSCH

35-1325.08	Ø 125 x 80 mm
35-1325.10	Ø 125 x 100 mm
35-1325.25	Ø 125 x 125 mm
35-1350.08	Ø 150 x 80 mm
35-1350.10	Ø 150 x 100 mm
35-1350.13	Ø 150 x 130 mm
35-1350.15	Ø 150 x 150 mm
35-1350.19	Ø 150 x 190 mm

35-1359.14	Ø 190 x 145 mm
35-1359.16	Ø 190 x 165 mm
35-1359.19	Ø 190 x 190 mm
35-1359.24	Ø 190 x 240 mm
35-1365.14	Ø 240 x 145 mm
35-1365.16	Ø 240 x 165 mm
35-1365.19	Ø 240 x 190 mm
35-1365.24	Ø 240 x 240 mm
35-1365.29	Ø 240 x 290 mm
35-1365.34	Ø 240 x 340 mm
35-1365.39	Ø 240 x 390 mm
35-1366.14	Ø 290 x 145 mm
35-1366.16	Ø 290 x 165 mm
35-1366.19	Ø 290 x 190 mm
35-1366.24	Ø 290 x 240 mm
35-1366.29	Ø 290 x 290 mm
35-1366.34	Ø 290 x 340 mm

35-1366.39	Ø 290 x 390 mm
35-1370.14	Ø 340 x 145 mm
35-1370.16	Ø 340 x 165 mm
35-1370.19	Ø 340 x 190 mm
35-1370.24	Ø 340 x 240 mm
35-1370.29	Ø 340 x 290 mm
35-1370.34	Ø 340 x 340 mm
35-1370.39	Ø 340 x 390 mm
35-1371.14	Ø 390 x 145 mm
35-1371.16	Ø 390 x 165 mm
35-1371.19	Ø 390 x 190 mm
35-1371.24	Ø 390 x 240 mm
35-1371.29	Ø 390 x 290 mm
35-1371.34	Ø 390 x 340 mm
35-1371.39	Ø 390 x 390 mm
35-1371.49	Ø 390 x 490 mm
35-1371.59	Ø 390 x 590 mm



KONRICH

35-1383.08	Ø 125 x 80 mm
35-1383.10	Ø 125 x 100 mm
35-1383.25	Ø 125 x 125 mm
35-1384.08	Ø 150 x 80 mm
35-1384.10	Ø 150 x 100 mm
35-1384.13	Ø 150 x 130 mm
35-1384.15	Ø 150 x 150 mm
35-1384.19	Ø 150 x 190 mm

35-1385.14	Ø 190 x 145 mm
35-1385.16	Ø 190 x 165 mm
35-1385.19	Ø 190 x 190 mm
35-1385.24	Ø 190 x 240 mm
35-1388.14	Ø 240 x 145 mm
35-1388.16	Ø 240 x 165 mm
35-1388.19	Ø 240 x 190 mm
35-1388.24	Ø 240 x 240 mm
35-1388.29	Ø 240 x 290 mm
35-1388.34	Ø 240 x 340 mm
35-1388.39	Ø 240 x 390 mm
35-1390.14	Ø 290 x 145 mm
35-1390.16	Ø 290 x 165 mm
35-1390.19	Ø 290 x 190 mm
35-1390.24	Ø 290 x 240 mm
35-1390.29	Ø 290 x 290 mm
35-1390.34	Ø 290 x 340 mm

35-1390.39	Ø 290 x 390 mm
35-1391.14	Ø 340 x 145 mm
35-1391.16	Ø 340 x 165 mm
35-1391.19	Ø 340 x 190 mm
35-1391.24	Ø 340 x 240 mm
35-1391.29	Ø 340 x 290 mm
35-1391.34	Ø 340 x 340 mm
35-1391.39	Ø 340 x 390 mm
35-1395.14	Ø 390 x 145 mm
35-1395.16	Ø 390 x 165 mm
35-1395.19	Ø 390 x 190 mm
35-1395.24	Ø 390 x 240 mm
35-1395.29	Ø 390 x 290 mm
35-1395.34	Ø 390 x 340 mm
35-1395.39	Ø 390 x 390 mm
35-1395.49	Ø 390 x 490 mm
35-1395.59	Ø 390 x 590 mm

Alphanumeric Index

Item Numbers at a Glance

Item #		02-2013.00	19	03-0112.22	25	04-1120.20	34	04-1141.16	34
01-1010.00	10	02-2021.00	19	03-0112.23	25	04-1121.10	34	04-1142.14	53
01-1109.00	10	02-2023.00	19	03-0112.24	25	04-1121.11	34	04-1142.16	53
01-1110.00	10	02-2030.00	20	03-0112.25	25	04-1121.13	34	04-1143.14	53
01-1111.00	10	02-2032.00	20	03-0112.34	25	04-1121.14	34	04-1143.16	53
01-1112.01	11	02-2041.00	19	03-0112.36	25	04-1121.15	34	04-1220.14	35
01-1112.02	11	02-2041.01	19	03-0113.24	25	04-1121.16	34	04-1224.14	35
01-1113.00	11	02-2041.02	19	03-0113.36	25	04-1121.18	34	04-1225.14	35
01-1114.00	11	02-2041.03	19	03-0120.09	26	04-1121.20	34	04-1234.14	54
01-1200.00	11	02-2041.04	19	03-0121.09	26	04-1122.14	53	04-1235.14	54
01-1210.00	11	02-2045.00	19	03-0124.13	26	04-1122.16	53	04-1242.14	35
01-1220.00	11	02-2045.01	19	03-0220.01	27	04-1123.14	53	04-1243.14	35
01-1300.90	12	02-2045.02	19	03-0220.02	27	04-1123.16	53	04-1252.14	54
01-1300.91	12	02-2045.03	19	03-0220.03	27	04-1130.10	34	04-1253.14	54
01-1300.92	12	02-2045.04	19	03-0220.04	27	04-1130.11	34	04-1256.14	35
01-1310.00	12	02-2046.00	20	03-0220.05	27	04-1130.13	34	04-1257.14	35
01-1310.01	12	02-2046.01	20	03-0220.06	27	04-1130.14	34	04-1260.14	36
01-1312.00	12	02-2046.03	20	03-0220.07	27	04-1130.15	34	04-1260.17	36
01-1312.01	12	02-2046.04	20	03-0220.08	27	04-1130.16	34	04-1260.23	36
01-1312.06	12	02-2050.28	21	03-0220.09	27	04-1130.18	34	04-1261.14	36
01-1405.00	13	02-2050.37	21	03-0220.10	27	04-1130.20	34	04-1261.17	36
01-1406.00	13	02-2051.01	21	03-0224.01	28	04-1131.10	34	04-1261.23	36
01-1500.17	14	02-2051.02	21	03-0224.02	28	04-1131.11	34	04-1264.14	54
01-1500.20	14	02-2055.02	21	03-0306.05	29	04-1131.13	34	04-1264.17	54
01-1504.16	14	02-2056.00	21	03-0308.05	29	04-1131.14	34	04-1264.23	54
01-1510.22	14	03-0100.03	24	03-0318.13	28	04-1131.15	34	04-1265.14	54
01-1511.24	14	03-0100.13	24	03-0318.16	28	04-1131.16	34	04-1265.17	54
01-1513.20	14	03-0102.04	24	03-0318.19	28	04-1131.18	34	04-1265.23	54
01-1514.20	14	03-0102.14	24	03-0318.22	28	04-1131.20	34	04-1270.15	36
01-1515.17	14	03-0103.07	24	03-0318.28	28	04-1132.14	53	04-1270.17	36
01-1517.18	14	03-0103.17	24	03-0320.17	28	04-1132.16	53	04-1271.15	36
01-1610.01	15	03-0104.08	24	03-0320.20	28	04-1133.14	53	04-1271.17	36
01-1615.01	15	03-0105.10	25	03-0420.00	30	04-1133.16	53	04-1274.15	55
01-1620.19	15	03-0105.11	25	03-0420.01	30	04-1140.10	34	04-1274.17	55
01-1625.10	15	03-0105.12	25	03-0420.02	30	04-1140.11	34	04-1275.15	55
01-1625.20	15	03-0105.13	25	03-0510.25	29	04-1140.13	34	04-1275.17	55
01-1625.30	15	03-0105.14	25	03-0590.16	29	04-1140.14	34	04-1280.17	37
01-1625.50	15	03-0105.15	25	03-0590.20	29	04-1140.15	34	04-1281.17	37
01-1627.15	15	03-0105.16	25	03-0590.24	29	04-1140.16	34	04-1300.16	36
02-1002.10	18	03-0105.17	25	04-1120.10	34	04-1140.18	34	04-1300.21	36
02-1004.08	18	03-0106.12	25	04-1120.11	34	04-1140.20	34	04-1301.16	36
02-1005.27	18	03-0106.15	25	04-1120.13	34	04-1141.10	34	04-1301.21	36
02-1010.17	18	03-0112.18	25	04-1120.14	34	04-1141.11	34	04-1304.16	55
02-1010.20	18	03-0112.19	25	04-1120.15	34	04-1141.13	34	04-1304.21	55
02-1010.25	18	03-0112.20	25	04-1120.16	34	04-1141.14	34	04-1305.16	55
02-2011.00	19	03-0112.21	25	04-1120.18	34	04-1141.15	34	04-1305.21	55

04-1310.10	37	04-1336.23	56	04-1435.17	41	04-1571.16	45	04-1755.18	59
04-1311.10	37	04-1336.25	56	04-1437.17	41	04-1573.15	45	04-1761.23	51
04-1314.10	55	04-1336.28	56	04-1445.18	42	04-1580.14	45	04-1763.20	52
04-1315.10	55	04-1337.15	56	04-1447.19	42	04-1580.22	45	04-1763.22	52
04-1320.11	37	04-1337.18	56	04-1449.17	42	04-1590.11	46	04-1770.14	52
04-1320.15	37	04-1337.20	56	04-1480.11	42	04-1591.11	46	04-1773.23	52
04-1320.18	37	04-1337.23	56	04-1483.21	43	04-1592.15	46	04-1775.23	52
04-1320.20	37	04-1337.25	56	04-1483.24	43	04-1593.15	46	04-1777.23	52
04-1320.23	37	04-1337.28	56	04-1490.25	43	04-1601.22	46	04-1779.23	59
04-1320.25	37	04-1339.12	38	04-1490.40	43	04-1610.18	47	04-1780.20	52
04-1320.28	37	04-1341.18	38	04-1490.60	43	04-1611.18	47	04-1782.15	52
04-1320.30	37	04-1345.18	57	04-1494.25	58	04-1614.19	47	04-1782.18	52
04-1321.11	37	04-1350.14	38	04-1494.40	58	04-1617.17	47	05-1120.11	62
04-1321.15	37	04-1351.14	38	04-1494.60	58	04-1619.17	47	05-1122.11	62
04-1321.18	37	04-1352.14	39	04-1501.16	43	04-1621.30	48	05-1124.12	62
04-1321.20	37	04-1353.14	39	04-1501.23	43	04-1623.19	47	05-1125.11	62
04-1321.23	37	04-1360.12	39	04-1501.28	43	04-1623.25	47	05-1127.11	62
04-1321.25	37	04-1360.15	39	04-1502.16	43	04-1631.24	48	05-1129.11	62
04-1321.28	37	04-1364.12	57	04-1502.23	43	04-1641.23	48	05-1131.10	62
04-1321.30	37, 56	04-1364.15	57	04-1502.28	43	04-1650.21	49	05-1133.10	62
04-1324.11	56	04-1370.15	39	04-1503.16	43	04-1652.21	49	05-1135.10	63
04-1324.15	56	04-1371.15	39	04-1503.23	43	04-1654.21	49	05-1137.10	63
04-1324.18	56	04-1374.15	57	04-1503.28	43	04-1660.09	49	05-1140.08	63
04-1324.20	56	04-1375.15	57	04-1505.15	42	04-1662.11	49	05-1141.08	63
04-1324.23	56	04-1380.09	39	04-1507.15	42	04-1663.13	49	05-1143.11	63
04-1324.25	56	04-1380.11	39	04-1521.22	44	04-1664.14	49	05-1145.11	63
04-1324.28	56	04-1381.09	39	04-1523.22	44	04-1669.15	49	05-1147.11	63
04-1324.30	56	04-1381.11	39	04-1525.22	58	04-1670.13	50	05-1152.18	64
04-1325.11	56	04-1384.11	57	04-1525.23	58	04-1671.13	50	05-1153.18	64
04-1325.15	56	04-1385.11	57	04-1527.22	58	04-1674.12	50	05-1156.18	64
04-1325.18	56	04-1391.09	40	04-1530.20	44	04-1675.12	50	05-1157.18	64
04-1325.20	56	04-1393.09	40	04-1530.23	44	04-1677.12	50	06-0200.10	68
04-1325.23	56	04-1394.11	40	04-1531.20	44	04-1731.12	51	06-0200.11	68
04-1325.25	56	04-1395.11	40	04-1531.23	44	04-1735.12	59	06-0200.13	68
04-1325.28	56	04-1396.11	40	04-1534.23	58	04-1740.10	51	06-0200.14	68
04-1331.15	38	04-1397.11	40	04-1543.24	44	04-1741.10	51	06-0200.16	68
04-1331.18	38	04-1400.11	40	04-1545.22	44	04-1742.10	51	06-0200.18	68
04-1331.20	38	04-1401.11	40	04-1550.17	44	04-1743.10	51	06-0200.20	68
04-1331.23	38	04-1404.11	57	04-1551.17	44	04-1748.15	51	06-0200.25	68
04-1332.15	38	04-1405.11	57	04-1556.27	45	04-1748.16	51	06-0200.30	68
04-1332.18	38	04-1406.11	41	04-1557.27	45	04-1748.18	51	06-0208.11	68
04-1332.20	38	04-1407.11	41	04-1560.16	46	04-1748.20	51	06-0208.13	68
04-1332.23	38	04-1408.18	41	04-1560.18	46	04-1751.11	51	06-0208.14	68
04-1336.15	56	04-1410.15	41	04-1561.16	46	04-1751.14	51	06-0208.16	68
04-1336.18	56	04-1415.16	41	04-1561.18	46	04-1751.18	51	06-0208.18	68
04-1336.20	56	04-1431.14	42	04-1570.10	45	04-1751.20	51	06-0208.20	68

GENERAL SURGERY.

06-0208.25	68	06-1223.16	71	06-5344.20	74	07-0070.12	82	07-0623.18	85
06-0208.30	68	06-1223.18	71	06-5344.25	74	07-0071.07	82	07-0623.21	85
06-0212.14	70	06-1223.20	71	06-5862.11	76	07-0071.08	82	07-0650.19	97
06-0212.16	70	06-1223.25	71	06-5864.11	76	07-0071.10	82	07-0651.19	97
06-0312.12	68	06-1234.13	71	06-5866.11	76	07-0071.12	82	07-0652.19	97
06-0312.13	68	06-1234.14	71	06-5867.11	76	07-0150.06	82	07-0653.19	97
06-0312.14	68	06-1234.16	71	06-5902.07	76	07-0150.07	82	07-0655.18	97
06-0312.15	68	06-1245.13	71	06-5902.09	76	07-0150.09	82	07-0671.14	93
06-0312.18	68	06-1245.14	71	06-5902.11	76	07-0150.11	82	07-0700.14	87
06-0312.21	68	06-1245.16	71	06-5906.10	76	07-0151.06	82	07-0710.15	96
06-0312.25	68	06-1312.12	71	06-5907.10	76	07-0151.07	82	07-0711.15	96
06-0320.15	68	06-1312.13	71	06-5908.10	76	07-0151.09	82	07-0712.15	96
06-0320.17	68	06-1312.14	71	06-5909.10	76	07-0151.11	82	07-0713.15	96
06-0350.12	68	06-1312.15	71	06-5920.09	76	07-0160.04	83	07-0726.14	87
06-0350.15	68	06-1312.18	71	06-5920.11	76	07-0160.05	83	07-0727.14	87
06-0351.12	68	06-1312.21	71	06-5932.13	77	07-0161.04	83	07-0730.20	97
06-0351.15	68	06-1312.25	71	06-5933.13	77	07-0161.05	83	07-0731.20	97
06-0360.15	68	06-1320.15	72	06-5934.14	77	07-0170.50	83	07-0733.20	97
06-0370.18	69	06-1332.14	72	06-5935.11	77	07-0170.55	83	07-0751.24	101
06-0371.18	69	06-1334.14	72	06-5935.14	77	07-0170.65	83	07-0774.20	96
06-0373.18	69	06-1342.18	72	06-5938.15	77	07-0170.70	83	07-0774.26	96
06-0380.12	69	06-1344.18	72	06-7022.12	78	07-0170.75	83	07-0775.20	96
06-0380.15	69	06-1350.12	72	06-7022.15	78	07-0170.90	83	07-0775.26	96
06-0384.12	70	06-1350.15	72	06-7022.18	78	07-0171.50	83	07-0776.20	96
06-0384.15	70	06-1351.12	72	06-7023.12	78	07-0171.55	83	07-0776.26	96
06-0386.12	69	06-1351.15	72	06-7023.15	78	07-0171.65	83	07-0777.20	96
06-0390.17	69	06-1366.15	72	06-7023.18	78	07-0171.70	83	07-0777.26	96
06-0420.18	69	06-1370.18	73	06-8014.16	78	07-0171.75	83	07-0800.14	86
06-0420.21	69	06-1371.18	73	06-8014.20	78	07-0171.90	83	07-0801.14	86
06-0420.25	69	06-1373.18	73	06-8014.24	78	07-0520.10	84	07-0802.16	86
06-0424.18	70	06-1380.12	73	06-8014.30	78	07-0521.10	84	07-0803.16	86
06-0424.21	70	06-1380.15	73	06-8016.16	78	07-0522.10	84	07-0820.14	86
06-0424.25	70	06-1386.12	73	06-8016.20	78	07-0523.10	84	07-0820.16	87
06-1200.10	71	06-1390.17	73	06-8016.24	78	07-0600.12	84	07-0821.14	86
06-1200.11	71	06-1420.18	73	06-8028.16	78	07-0601.12	84	07-0822.14	86
06-1200.13	71	06-1420.21	73	06-8028.20	78	07-0602.12	84	07-0823.14	86
06-1200.14	71	06-1420.25	73	06-8028.24	78	07-0603.12	84	07-0824.16	87
06-1200.16	71	06-5020.10	74	06-8028.30	78	07-0620.12	85	07-0826.16	87
06-1200.18	71	06-5110.15	74	06-8029.16	78	07-0620.14	85	07-0827.16	87
06-1200.20	71	06-5110.20	74	06-8029.20	78	07-0620.18	85	07-0828.16	87
06-1200.25	71	06-5146.15	74	06-8029.24	78	07-0620.21	85	07-0829.16	87
06-1200.30	71	06-5210.15	74	06-8029.30	78	07-0621.12	85	07-0840.15	104
06-1208.11	71	06-5210.20	74	06-8030.16	78	07-0621.14	85	07-0841.15	104
06-1208.13	71	06-5210.25	74	06-8030.20	78	07-0621.18	85	07-0860.16	92
06-1208.14	71	06-5260.23	75	06-8030.24	78	07-0621.21	85	07-0860.20	92
06-1208.16	71	06-5270.23	75	06-8030.30	78	07-0622.12	85	07-0861.16	92
06-1208.18	71	06-5314.07	74	06-8032.16	78	07-0622.14	85	07-0861.20	92
06-1208.20	71	06-5320.20	74	06-8032.20	78	07-0622.18	85	07-0920.14	94
06-1208.25	71	06-5330.23	75	07-0070.07	82	07-0622.21	85	07-0930.14	87
06-1223.13	71	06-5340.12	74	07-0070.08	82	07-0623.12	85	07-0931.14	87
06-1223.14	71	06-5344.16	74	07-0070.10	82	07-0623.14	85	07-0940.13	88

07-0940.14	88	07-1083.21	100	07-4501.19	94	08-9111.11	115	09-0586.04	128
07-0940.16	88	07-1109.28	102	07-4504.15	94	08-9111.13	115	09-0586.12	128
07-0940.18	88	07-1115.28	102	07-4524.16	93	08-9121.13	115	09-0586.13	128
07-0940.20	88	07-1521.14	103	07-4525.16	93	08-9306.13	118	09-0586.14	128
07-0940.22	88	07-1521.18	103	07-4542.16	95	08-9346.25	118	09-0591.02	131
07-0940.24	88	07-1523.15	104	07-4601.23	106	08-9380.20	116	09-0591.03	131
07-0940.26	88	07-1523.18	104	07-4613.25	109	08-9380.25	116	09-0591.04	131
07-0940.28	88	07-1539.26	104	07-4621.23	107	08-9381.20	116	09-0591.06	131
07-0940.30	88	07-1551.19	105	07-4623.20	106	08-9381.25	116	09-0591.12	131
07-0941.13	89	07-1551.23	105	07-4623.22	107	08-9500.25	118	09-0591.13	131
07-0941.14	89	07-1559.20	105	07-4623.24	107	08-9503.25	118	09-0591.14	131
07-0941.16	89	07-1563.22	104	07-4626.23	106	08-9510.22	116	09-0591.16	131
07-0941.18	89	07-1563.25	104	07-4627.23	106	08-9510.25	116	09-0610.16	124
07-0941.20	89	07-1563.28	104	07-4825.18	105	08-9511.22	116	09-0611.16	124
07-0941.22	89	07-1573.22	103	07-4837.21	106	08-9511.25	116	09-0836.16	130
07-0941.24	89	07-1583.14	105	07-4841.21	106	08-9520.18	117	09-0836.26	130
07-0941.26	89	07-1583.16	105	07-4853.22	107	08-9520.25	117	09-0850.20	129
07-0941.28	89	07-1583.18	104	07-4853.23	107	08-9521.18	117	09-0850.21	129
07-0941.30	89	07-1583.23	104	07-4855.22	107	08-9521.25	117	09-0856.12	129
07-1028.14	92	07-1701.01	99	07-4855.23	107	08-9522.18	117	09-0856.14	129
07-1029.14	92	07-1701.02	99	07-4865.23	104	08-9522.20	117	09-0856.16	129
07-1030.13	90	07-1701.03	100	07-6100.21	108	08-9522.25	117	09-0856.18	129
07-1030.14	90	07-1701.04	100	07-6101.21	108	08-9523.18	117	09-0940.08	129
07-1030.16	90	07-1711.03	98	07-6127.21	107	08-9523.20	117	09-0940.10	129
07-1030.18	90	07-1711.04	98	07-6135.23	108	08-9523.25	117	09-0940.12	129
07-1030.20	90	07-1711.05	98	07-6136.23	108	08-9544.25	117	09-0940.14	129
07-1030.22	90	07-1711.06	98	07-6223.20	108	08-9545.25	117	09-0940.16	129
07-1030.24	90	07-1711.07	98	07-6243.20	108	08-9546.25	117	09-0940.18	129
07-1030.26	90	07-1713.01	98	07-6245.20	109	08-9547.13	118	09-1061.01	131
07-1030.28	90	07-1713.02	98	07-6321.20	109	08-9570.26	119	09-1061.02	131
07-1030.30	90	07-1713.03	98	07-6323.20	109	08-9579.26	119	09-1061.03	131
07-1031.13	91	07-1713.04	98	07-9900.15	110	09-0136.13	127	09-1061.04	131
07-1031.14	91	07-1713.05	98	07-9900.18	110	09-0136.18	127	09-1061.06	131
07-1031.16	91	07-1713.06	98	07-9900.20	110	09-0350.12	127	09-1061.11	131
07-1031.18	91	07-1713.07	98	07-9902.15	110	09-0351.12	127	09-1061.12	131
07-1031.20	91	07-1743.13	98	07-9902.18	110	09-0362.01	127	09-1061.13	131
07-1031.22	91	07-1743.16	98	07-9902.20	110	09-0362.02	127	09-1061.14	131
07-1031.24	91	07-1743.18	99	07-9906.14	109	09-0516.01	127	09-1061.16	131
07-1031.26	91	07-1743.20	99	07-9912.16	109	09-0516.02	127	09-1071.01	130
07-1031.28	91	07-1743.23	99	08-9013.09	114	09-0516.05	127	09-1071.02	130
07-1031.30	91	07-1743.25	99	08-9015.09	114	09-0516.07	127	09-1071.03	130
07-1050.14	92	07-1743.28	99	08-9021.09	114	09-0516.10	127	09-1071.04	130
07-1051.14	92	07-1745.18	99	08-9043.18	115	09-0556.01	128	09-1071.05	130
07-1059.01	101	07-1745.22	99	08-9050.20	115	09-0556.02	128	09-1071.06	130
07-1059.02	102	07-1745.25	99	08-9065.09	114	09-0556.03	128	09-1124.08	136
07-1066.24	101	07-1745.28	99	08-9065.11	114	09-0556.04	128	09-1124.18	136
07-1067.24	101	07-4310.13	95	08-9065.13	114	09-0556.11	128	09-1145.08	135
07-1070.22	100	07-4312.13	95	08-9065.15	114	09-0556.12	128	09-1155.40	135
07-1071.22	100	07-4350.14	95	08-9067.11	114	09-0556.13	128	09-1155.50	135
07-1080.21	100	07-4372.15	94	08-9069.13	114	09-0556.14	128	09-1155.60	135
07-1081.21	100	07-4377.15	94	08-9101.16	115	09-0586.02	128	09-1155.70	136
07-1082.21	100	07-4501.14	94	08-9103.19	115	09-0586.03	128	09-1172.01	132

GENERAL SURGERY.

09-1172.02	132	09-2240.08	126	09-2766.37	125	09-6040.10	151	10-0082.10	159
09-1172.03	132	09-2240.09	126	09-2780.12	125	09-6041.60	151	10-0100.13	158
09-1172.04	132	09-2241.25	125	09-2780.17	125	09-6041.80	151	10-0100.14	158
09-1172.05	132	09-2241.38	125	09-2780.25	125	09-6050.10	151	10-0100.16	158
09-1181.01	132	09-2241.50	125	09-5107.04	142	09-6214.16	148	10-0100.18	158
09-1181.02	132	09-2252.22	140	09-5107.14	142	09-6215.14	148	10-0100.20	158
09-1181.03	132	09-2252.38	140	09-5110.04	143	09-6230.45	153	10-0101.14	159
09-1181.04	132	09-2252.45	140	09-5110.14	143	09-6230.70	153	10-0110.13	158
09-1181.05	132	09-2252.65	140	09-5130.04	143	09-6230.80	153	10-0110.14	158
09-1191.60	133	09-2255.25	141	09-5130.14	143	09-6232.09	150	10-0110.16	158
09-1233.00	133	09-2255.45	141	09-5134.34	141	09-6240.18	150	10-0110.18	158
09-1233.01	153	09-2255.60	141	09-5134.44	141	09-6244.20	150	10-0502.13	159
09-1233.02	152	09-2255.75	141	09-5211.23	143	09-6244.25	150	10-0502.14	159
09-1233.03	152	09-2268.22	139	09-5211.43	143	09-6320.10	153	10-0642.15	161
09-1233.04	152	09-2268.27	139	09-5213.34	143	09-6320.55	152	10-0712.12	161
09-1233.05	133	09-2269.45	140	09-5213.44	143	09-6320.65	152	10-0712.14	161
09-1233.06	133	09-2269.73	140	09-5214.34	144	09-6324.10	152	10-0712.16	161
09-1233.07	133	09-2269.82	140	09-5214.44	144	09-6324.98	152	10-0712.18	161
09-1233.08	133	09-2324.40	136	09-5216.34	144	09-6330.10	153	10-0712.23	161
09-1233.09	133	09-2324.50	136	09-5216.44	144	09-6810.10	148	10-0732.12	161
09-1239.28	130	09-2324.60	137	09-5220.34	144	09-6812.85	148	10-0732.14	161
09-1242.12	130	09-2324.70	137	09-5220.44	144	09-6830.09	146	10-0732.16	161
09-1254.18	133	09-2335.85	138	09-5312.03	143	09-6830.14	147	10-0732.18	161
09-1254.20	133	09-2342.25	137	09-5312.13	143	09-6830.16	147	10-0732.23	161
09-1254.25	133	09-2345.45	137	09-5363.11	143	09-6830.18	147	10-0815.12	161
09-1254.30	133	09-2345.55	137	09-5364.11	143	09-6831.18	149	10-0815.14	161
09-1254.40	134	09-2345.65	137	09-5445.44	145	09-6832.18	149	10-0815.16	161
09-1275.10	133	09-2361.35	138	09-5620.44	144	09-7915.03	134	10-0815.18	161
09-1275.15	134	09-2361.50	138	09-5620.84	144	09-7924.10	134	10-0816.12	161
09-1275.20	135	09-2361.55	138	09-5626.44	144	10-0010.11	158	10-0816.14	161
09-2010.20	135	09-2361.60	138	09-5626.84	144	10-0010.13	158	10-0816.16	161
09-2010.26	135	09-2371.38	139	09-5681.44	145	10-0010.14	158	10-0816.18	161
09-2050.22	134	09-2371.57	139	09-5693.45	145	10-0010.16	158	10-0828.12	161
09-2061.50	141	09-2395.16	124	09-5702.77	145	10-0010.18	158	10-0828.18	161
09-2061.90	141	09-2500.19	124	09-5854.18	145	10-0010.20	158	10-1150.45	161
09-2074.28	123	09-2516.00	122	09-5855.18	146	10-0010.25	158	10-5650.00	159
09-2074.36	123	09-2516.13	124	09-5910.00	148	10-0052.11	158	10-5650.02	159
09-2074.44	123	09-2516.25	124	09-5910.01	148	10-0052.13	158	10-5650.03	159
09-2074.52	123	09-2517.11	124	09-5910.40	148	10-0052.14	158	10-5650.06	159
09-2075.00	123	09-2543.00	122	09-5910.45	148	10-0052.16	158	10-5650.09	159
09-2076.65	123	09-2545.00	122	09-5910.50	148	10-0052.18	158	10-5650.12	159
09-2078.38	123	09-2563.00	122	09-5910.55	148	10-0052.20	158	10-5650.15	159
09-2232.25	125	09-2568.00	122	09-5910.60	148	10-0052.25	158	10-5650.80	159
09-2232.40	125	09-2589.00	122	09-5910.95	148	10-0053.11	158	10-5650.90	159
09-2232.62	125	09-2591.00	122	09-5912.00	149	10-0053.13	158	10-5681.04	160
09-2240.01	126	09-2751.28	125	09-5912.01	148	10-0053.14	158	10-5681.06	160
09-2240.02	126	09-2763.25	125	09-5912.40	148	10-0053.16	158	10-5681.07	160
09-2240.03	126	09-2763.32	125	09-5912.45	148	10-0053.18	158	10-5681.08	160
09-2240.04	126	09-2763.40	125	09-5912.50	148	10-0053.20	158	10-5681.10	160
09-2240.05	126	09-2763.50	125	09-5912.55	148	10-0053.25	158	10-5681.12	160
09-2240.06	126	09-2766.18	125	09-5912.60	148	10-0065.14	158	10-5681.14	160
09-2240.07	126	09-2766.30	125	09-5912.95	149	10-0065.16	158	10-5682.12	160

11-2130.40	164	11-5230.12	167	12-2514.14	181	12-5222.14	178	13-1015.03	188
11-2130.50	164	11-5232.07	167	12-2514.17	181	12-5222.16	178	13-1015.04	188
11-2131.30	164	11-5232.10	167	12-2516.14	174	12-5222.18	178	13-1019.01	188
11-2135.30	165	11-5232.12	167	12-2516.18	174	12-5222.20	178	13-1019.02	188
11-3004.00	164	11-5240.05	167	12-2518.14	181	12-5222.24	178	13-1019.03	188
11-3010.30	164	11-5240.10	167	12-2518.18	181	12-5222.26	178	13-1019.04	188
11-3010.35	164	11-5270.14	167	12-2520.17	175	12-5222.30	178	13-1021.01	188
11-3010.40	164	11-5270.20	167	12-2522.17	181	12-5224.16	171	13-1021.02	188
11-3010.45	164	12-2458.23	171	12-2524.16	175	12-5224.18	171	13-1021.03	188
11-3010.50	164	12-2460.23	179	12-2528.16	181	12-5224.20	171	13-1021.04	188
11-3010.55	164	12-2461.21	172	12-2530.16	182	12-5228.16	178	13-1023.01	188
11-3010.60	164	12-2463.21	179	12-2530.18	182	12-5228.18	178	13-1023.02	188
11-3012.30	164	12-2466.27	172	12-2530.20	182	12-5228.20	178	13-1023.03	188
11-3012.35	164	12-2468.27	180	12-2530.23	182	12-5302.15	171	13-1023.04	188
11-3012.40	164	12-2470.27	172	12-2530.26	182	12-5302.18	171	13-1027.00	187
11-3012.45	164	12-2472.27	180	12-2532.11	175	12-5302.20	171	13-1027.01	187
11-3012.50	164	12-2474.27	172	12-2534.13	175	12-5312.15	177	13-1027.02	187
11-3012.55	164	12-2476.27	180	12-2534.15	175	12-5312.18	177	13-1027.03	187
11-3012.60	164	12-2477.20	179	12-2536.12	175	12-5312.20	177	13-2030.01	189
11-3020.25	165	12-2477.24	179	12-2538.16	175	12-5320.15	171	13-2035.25	189
11-3020.30	165	12-2477.26	179	12-2540.16	182	12-5322.15	177	13-2068.19	189
11-3020.33	165	12-2478.18	172	12-2541.14	176	12-5450.15	178	13-2069.19	189
11-3020.35	165	12-2480.18	172	12-2544.14	176	12-5450.18	178	13-2089.20	189
11-3034.10	166	12-2481.27	173	12-2546.10	176	12-5450.20	178	13-2110.22	189
11-3034.12	166	12-2485.20	173	12-2547.10	176	12-5450.23	178	13-2111.22	189
11-3034.14	166	12-2485.27	173	12-2549.13	176, 182	12-5450.26	178	13-2125.18	189
11-3034.16	166	12-2487.20	180	12-2552.14	176	12-5450.28	178	13-2125.27	189
11-3034.18	166	12-2487.27	180	12-2553.14	176	12-5450.30	178	13-5711.18	195
11-3034.20	166	12-2488.18	173	12-2555.14	182	12-5456.13	179	13-5720.12	195
11-3034.22	166	12-2488.26	173	12-2556.13	176	12-5456.15	179	13-5730.12	195
11-3034.24	166	12-2490.18	179	12-2557.14	182	12-5456.18	179	13-5732.12	195
11-3034.26	166	12-2490.26	179	12-2558.13	182	12-5456.20	179	13-5734.12	195
11-3034.28	166	12-2492.23	173	12-5024.12	170	12-5456.23	179	13-5821.16	197
11-3040.00	165	12-2494.23	179	12-5026.12	177	13-0714.13	187	13-5821.20	197
11-3115.30	165	12-2496.15	174	12-5028.13	170	13-0715.13	187	13-5821.24	197
11-3154.18	165	12-2498.18	174	12-5030.13	170	13-0717.24	187	13-8010.01	190
11-3810.35	166	12-2500.18	182	12-5032.13	170	13-0718.24	187	13-8010.02	190
11-3810.70	166	12-2503.25	173	12-5034.13	170	13-0721.21	186	13-8010.03	190
11-3812.70	166	12-2504.14	174	12-5036.13	177	13-0721.24	186	13-8010.04	190
11-3812.99	166	12-2504.17	174	12-5038.13	177	13-0721.27	186	13-8010.05	190
11-3814.70	166	12-2504.20	174	12-5040.13	170	13-0723.21	186	13-8010.06	190
11-3814.99	166	12-2504.24	174	12-5042.13	171	13-0723.24	186	13-8010.07	190
11-3816.70	166	12-2506.14	181	12-5042.14	171	13-0723.27	186	13-8010.08	190
11-3818.99	166	12-2506.17	181	12-5046.13	177	13-0725.21	186	13-8010.09	190
11-3830.14	166	12-2506.20	181	12-5048.14	177	13-0725.24	186	13-8010.10	190
11-3830.18	166	12-2506.24	181	12-5220.14	171	13-0725.27	186	13-8010.11	190
11-3830.64	166	12-2508.17	174	12-5220.16	171	13-0727.21	186	13-8010.12	190
11-3830.68	166	12-2508.20	174	12-5220.18	171	13-0727.24	186	13-8010.13	190
11-3851.00	166	12-2510.17	181	12-5220.20	171	13-0727.27	186	13-8010.14	190
11-5220.00	167	12-2510.20	181	12-5220.24	171	13-0765.19	187	13-8010.15	190
11-5230.07	167	12-2512.14	174	12-5220.26	171	13-1015.01	188	13-8010.16	190
11-5230.10	167	12-2512.17	174	12-5220.30	171	13-1015.02	188	13-8011.01	190

GENERAL SURGERY.

13-8011.02	190	13-8016.01	192	13-9510.11	196	15-0151.14	214	15-1022.12	227
13-8011.03	190	13-8016.02	192	13-9510.12	196	15-0151.17	214	15-1022.14	227
13-8011.04	190	13-8016.03	192	13-9510.14	196	15-0151.19	214	15-1022.16	227
13-8011.05	190	13-8016.04	192	13-9510.16	196	15-0151.22	214	15-1024.08	227
13-8011.06	190	13-8016.05	192	13-9510.18	196	15-0200.15	214	15-1024.10	227
13-8011.07	190	13-8016.10	192	13-9510.20	196	15-0201.15	214	15-1024.12	227
13-8011.08	190	13-8016.20	192	13-9510.22	196	15-0210.19	214	15-1024.14	227
13-8011.09	190	13-8016.30	192	13-9514.60	196	15-0211.19	214	15-1024.16	227
13-8011.10	190	13-8018.01	193	13-9952.20	197	15-0219.25	234	15-1050.18	211
13-8011.11	190	13-8018.02	193	13-9952.30	197	15-0221.68	234	15-1051.18	211
13-8011.12	190	13-8018.03	193	13-9954.23	197	15-0228.32	235	15-1055.23	210
13-8011.13	190	13-8018.04	193	13-9955.27	197	15-0228.92	235	15-1061.23	211
13-8011.14	190	13-8018.05	193	13-9956.20	197	15-0230.25	235	15-1062.02	228
13-8011.15	190	13-8018.06	193	13-9956.28	197	15-0230.40	235	15-1062.03	228
13-8011.16	190	13-8020.01	193	13-9957.20	197	15-0231.75	235	15-1062.04	228
13-8012.01	191	13-8020.02	193	13-9957.28	197	15-0300.27	215	15-1062.05	228
13-8012.02	191	13-8020.03	193	13-9960.12	198	15-0301.27	215	15-1062.06	228
13-8012.03	191	13-8020.04	193	13-9962.14	198	15-0305.27	215	15-1062.07	228
13-8012.04	191	13-8020.05	193	14-0600.23	202	15-0307.23	214	15-1062.08	228
13-8012.05	191	13-8020.06	193	14-0600.26	202	15-0531.12	208	15-1064.02	228
13-8012.06	191	13-8021.01	193	14-0600.37	202	15-0533.14	208	15-1064.03	228
13-8012.07	191	13-8021.02	193	14-0620.24	202	15-0535.90	208	15-1064.04	228
13-8012.08	191	13-8021.03	193	14-0622.19	202	15-0540.15	208	15-1064.05	228
13-8012.09	191	13-8021.04	193	14-0710.14	202	15-0544.14	208	15-1064.06	228
13-8012.10	191	13-8021.05	193	14-0712.18	202	15-0544.17	208	15-1064.07	228
13-8012.11	191	13-8021.10	193	14-0810.11	204	15-0561.17	208	15-1064.08	228
13-8012.12	191	13-8021.20	193	14-0810.22	204	15-0563.16	208	15-1065.23	211
13-8012.13	191	13-8022.01	194	14-0810.50	204	15-0576.30	209	15-1072.02	228
13-8012.14	191	13-8022.02	194	14-0810.65	204	15-0576.45	209	15-1072.03	228
13-8012.15	191	13-8022.03	194	14-0811.50	204	15-0576.90	209	15-1072.04	228
13-8012.16	191	13-8022.04	194	14-0811.65	204	15-0636.16	210	15-1072.05	228
13-8013.01	191	13-8022.05	194	14-0812.13	204	15-0637.16	210	15-1072.06	228
13-8013.02	191	13-8022.10	194	14-0920.28	203	15-0638.18	210	15-1072.07	228
13-8013.03	191	13-8022.20	194	14-0922.30	203	15-0639.18	210	15-1072.08	228
13-8013.04	191	13-8023.01	194	14-0924.28	203	15-0650.17	209	15-1074.02	228
13-8013.05	191	13-8023.02	194	14-0930.23	203	15-0651.17	209	15-1074.03	228
13-8013.06	191	13-8023.03	194	14-0932.20	203	15-0655.01	209	15-1074.04	228
13-8013.07	191	13-8023.04	194	14-0934.18	203	15-0655.02	209	15-1074.05	228
13-8013.08	191	13-8023.05	194	14-0936.18	203	15-0670.20	210	15-1074.06	228
13-8013.09	191	13-8023.10	194	14-0953.18	203	15-0671.20	210	15-1074.07	228
13-8015.01	192	13-8023.20	194	14-0953.24	203	15-0677.20	209	15-1074.08	228
13-8015.02	192	13-9010.12	196	15-0093.23	235	15-1000.15	211	15-1090.26	212
13-8015.03	192	13-9010.14	196	15-0100.45	234	15-1001.15	211	15-1091.22	212
13-8015.04	192	13-9010.16	196	15-0100.90	234	15-1011.18	210	15-1091.26	212
13-8015.05	192	13-9010.18	196	15-0110.19	214	15-1013.18	210	15-1095.23	212
13-8015.06	192	13-9010.20	196	15-0120.20	234	15-1020.08	227	15-1112.04	227
13-8015.07	192	13-9060.12	195	15-0144.34	234	15-1020.10	227	15-1112.06	227
13-8015.08	192	13-9061.13	195	15-0145.26	234	15-1020.12	227	15-1112.08	227
13-8015.09	192	13-9067.13	195	15-0150.14	214	15-1020.14	227	15-1112.10	227
13-8015.10	192	13-9069.14	195	15-0150.17	214	15-1020.16	227	15-1112.12	227
13-8015.11	192	13-9500.00	196	15-0150.19	214	15-1022.08	227	15-1112.14	227
13-8015.12	192	13-9510.07	196	15-0150.22	214	15-1022.10	227	15-1114.04	227

15-1114.06	227	15-1200.06	230	15-1251.32	231	15-1661.43	242	15-2096.50	224
15-1114.08	227	15-1200.08	230	15-1252.06	232	15-1662.22	242	15-2096.51	224
15-1114.10	227	15-1200.10	230	15-1252.13	232	15-1662.33	242	15-2096.52	224
15-1114.12	227	15-1200.12	230	15-1252.19	232	15-1664.24	242	15-2096.53	224
15-1114.14	227	15-1200.15	230	15-1252.25	232	15-1665.22	243	15-2096.54	224
15-1128.05	213	15-1210.06	230	15-1252.32	232	15-2002.20	220	15-2096.55	224
15-1128.08	213	15-1210.15	230	15-1254.06	232	15-2003.20	220	15-2096.56	224
15-1130.10	229	15-1210.20	230	15-1254.13	232	15-2008.19	221	15-2131.19	216
15-1130.15	229	15-1210.25	230	15-1254.19	232	15-2017.33	223	15-2144.51	224
15-1130.20	229	15-1210.30	230	15-1254.25	232	15-2017.42	223	15-2144.52	224
15-1130.25	229	15-1210.38	230	15-1254.32	232	15-2017.50	223	15-2144.53	224
15-1132.10	229	15-1210.44	230	15-1255.06	232	15-2017.51	223	15-2144.54	224
15-1132.15	229	15-1211.06	230	15-1255.13	232	15-2017.52	223	15-2144.55	224
15-1132.20	229	15-1211.15	230	15-1255.19	232	15-2017.53	223	15-2144.56	224
15-1132.25	229	15-1211.20	230	15-1255.25	232	15-2017.54	223	15-2150.21	216
15-1133.31	211	15-1211.25	230	15-1255.32	232	15-2027.24	223	15-2151.01	225
15-1134.10	229	15-1211.30	230	15-1613.22	233	15-2027.33	223	15-2151.02	225
15-1134.15	229	15-1211.38	230	15-1620.16	233	15-2027.42	223	15-2151.03	225
15-1134.20	229	15-1211.44	230	15-1625.60	244	15-2027.50	223	15-2152.21	216
15-1134.25	229	15-1230.06	231	15-1628.01	233	15-2027.51	223	15-2171.15	225
15-1135.24	212	15-1230.09	231	15-1628.02	233	15-2027.52	223	15-2171.24	225
15-1150.04	229	15-1230.10	231	15-1630.00	233	15-2027.53	223	15-2171.33	225
15-1150.06	229	15-1230.13	231	15-1630.26	243	15-2027.54	223	15-2171.42	225
15-1150.08	229	15-1230.16	231	15-1631.26	243	15-2027.55	223	15-2171.50	225
15-1150.10	229	15-1230.19	231	15-1633.17	244	15-2027.56	223	15-2171.51	225
15-1150.12	229	15-1230.25	231	15-1635.16	244	15-2035.19	221	15-2200.15	220
15-1154.04	229	15-1230.32	231	15-1636.60	244	15-2037.24	223	15-2200.25	220
15-1154.06	229	15-1231.06	231	15-1636.80	244	15-2037.33	223	15-2200.26	220
15-1154.08	229	15-1231.09	231	15-1637.16	244	15-2037.42	223	15-2200.27	220
15-1154.10	229	15-1231.10	231	15-1638.01	245	15-2037.50	223	15-2205.15	219
15-1154.12	229	15-1231.13	231	15-1638.02	245	15-2037.51	223	15-2205.19	219
15-1156.03	229	15-1231.16	231	15-1638.03	245	15-2037.52	223	15-2205.24	219
15-1156.05	229	15-1231.19	231	15-1639.19	245	15-2037.53	223	15-2205.26	219
15-1156.06	229	15-1231.25	231	15-1640.19	245	15-2037.54	223	15-2205.28	219
15-1156.08	229	15-1231.32	231	15-1641.22	245	15-2037.55	223	15-2310.13	226
15-1156.09	229	15-1234.06	231	15-1642.22	245	15-2037.56	223	15-2310.14	226
15-1160.07	230	15-1234.09	231	15-1644.01	246	15-2039.17	220	15-2310.17	226
15-1160.10	230	15-1234.10	231	15-1644.02	246	15-2041.13	221	15-2313.23	216
15-1160.15	230	15-1234.13	231	15-1644.03	246	15-2046.33	224	15-2313.26	216
15-1160.20	230	15-1234.16	231	15-1644.04	246	15-2046.42	224	15-2314.13	226
15-1160.25	230	15-1234.19	231	15-1644.05	246	15-2046.50	224	15-2314.16	226
15-1160.30	230	15-1234.25	231	15-1649.45	240	15-2046.51	224	15-2314.20	226
15-1162.21	213	15-1234.32	231	15-1649.65	240	15-2046.52	224	15-2315.26	216
15-1163.21	213	15-1250.06	231	15-1650.22	246	15-2046.53	224	15-2320.22	216
15-1164.07	230	15-1250.13	231	15-1651.24	246	15-2046.54	224	15-2320.27	216
15-1164.10	230	15-1250.19	231	15-1654.24	232	15-2046.55	224	15-2320.30	216
15-1164.15	230	15-1250.25	231	15-1655.27	246	15-2046.56	224	15-2323.00	226
15-1164.20	230	15-1250.32	231	15-1657.30	246	15-2084.20	221	15-2323.01	226
15-1164.25	230	15-1251.06	231	15-1660.08	241	15-2085.20	221	15-2323.12	226
15-1164.30	230	15-1251.13	231	15-1660.18	241	15-2091.23	221	15-2330.22	217
15-1200.03	230	15-1251.19	231	15-1660.43	241	15-2096.33	224	15-2330.26	217
15-1200.04	230	15-1251.25	231	15-1660.70	241	15-2096.42	224	15-2330.33	217

GENERAL SURGERY.

15-2331.19	217	15-3564.04	237	16-7430.16	254	16-7552.25	257	16-7580.20	259
15-2331.23	217	15-3564.05	237	16-7430.22	254	16-7552.28	257	16-7580.25	259
15-2331.26	217	15-3564.06	237	16-7431.14	254	16-7552.30	257	16-7580.30	259
15-2333.00	226	15-3564.07	237	16-7432.00	254	16-7552.32	257	16-7580.35	259
15-2333.01	226	15-4070.20	238	16-7433.00	254	16-7552.35	257	16-7580.40	259
15-2333.12	226	15-4071.20	238	16-7440.00	255	16-7552.40	257	16-7580.45	259
15-2340.15	217	15-4169.06	239	16-7441.00	255	16-7552.50	257	16-7580.50	259
15-2340.17	217	15-4169.12	239	16-7450.00	255	16-7554.10	257	16-7582.20	259
15-2340.21	217	15-4169.19	239	16-7451.00	255	16-7554.15	257	16-7582.25	259
15-2342.15	217	15-4169.25	239	16-7500.16	256	16-7554.20	257	16-7582.30	259
15-2342.17	217	15-4181.17	239	16-7500.92	256	16-7554.25	257	16-7582.35	259
15-2342.21	217	15-4183.19	239	16-7510.20	256	16-7554.28	257	16-7582.40	259
15-2360.33	218	15-4185.30	240	16-7520.00	256	16-7554.30	257	16-7582.45	259
15-2360.45	218	16-0206.00	250	16-7521.00	256	16-7554.32	257	16-7582.50	259
15-2362.33	218	16-1100.00	250	16-7530.02	262	16-7554.35	257	16-7584.20	259
15-2362.45	218	16-1230.30	251	16-7530.03	262	16-7554.40	257	16-7584.25	259
15-2400.15	222	16-1235.31	251	16-7530.04	262	16-7554.50	257	16-7584.30	259
15-2401.00	222	16-1250.00	251	16-7530.05	262	16-7554.60	257	16-7584.35	259
15-2401.18	222	16-1250.03	251	16-7530.06	262	16-7560.24	263	16-7584.40	259
15-2401.30	222	16-1250.05	251	16-7530.07	262	16-7560.32	263	16-7584.45	259
15-2402.01	222	16-1250.07	251	16-7530.08	262	16-7560.48	263	16-7584.50	259
15-2402.02	222	16-1677.23	251	16-7530.09	262	16-7560.64	263	16-7586.17	259
15-2410.13	222	16-1678.00	252	16-7530.10	262	16-7562.04	257	16-7586.22	259
15-2410.18	222	16-1678.01	252	16-7530.11	262	16-7562.06	257	16-7586.27	259
15-2410.20	222	16-1679.13	252	16-7530.12	262	16-7562.08	257	16-7586.32	259
15-3010.15	236	16-1680.00	252	16-7530.15	262	16-7562.10	257	16-7586.37	259
15-3011.15	236	16-1680.01	252	16-7531.00	256	16-7562.12	257	16-7586.42	259
15-3021.18	236	16-7401.00	253	16-7531.21	262	16-7562.14	257	16-7586.47	259
15-3031.10	236	16-7401.05	253	16-7532.00	256	16-7562.16	257	16-7587.00	259
15-3031.15	236	16-7401.08	253	16-7532.17	262	16-7562.24	263	16-7588.00	259
15-3031.20	236	16-7401.10	253	16-7533.00	256	16-7562.32	263	16-7590.00	259
15-3031.25	236	16-7401.12	253	16-7533.18	262	16-7562.48	263	16-7592.14	258
15-3057.01	239	16-7401.16	253	16-7534.15	262	16-7562.64	263	16-7595.21	258
15-3057.02	239	16-7401.25	253	16-7536.14	262	16-7564.04	257	16-7602.20	266
15-3057.03	239	16-7401.30	253	16-7540.16	263	16-7564.06	257	16-7606.10	260
15-3057.04	239	16-7401.35	253	16-7542.15	263	16-7564.08	257	16-7606.12	260
15-3116.65	236	16-7401.40	253	16-7545.22	263	16-7564.10	257	16-7606.14	260
15-3171.15	236	16-7401.90	253	16-7550.20	257	16-7564.12	257	16-7606.15	260
15-3504.22	238	16-7402.10	253	16-7550.25	257	16-7564.14	257	16-7606.16	260
15-3505.22	238	16-7402.15	253	16-7550.30	257	16-7564.16	257	16-7606.18	260
15-3510.17	237	16-7402.20	253	16-7550.32	257	16-7566.12	257	16-7606.20	260
15-3511.17	237	16-7410.00	254	16-7550.35	257	16-7568.08	257	16-7606.22	260
15-3520.17	237	16-7410.30	254	16-7550.40	257	16-7568.10	257	16-7612.10	260
15-3521.17	237	16-7410.90	254	16-7550.50	257	16-7570.12	257	16-7612.12	260
15-3529.29	238	16-7420.00	253	16-7550.60	257	16-7570.15	257	16-7612.14	260
15-3533.16	236	16-7420.25	253	16-7550.70	257	16-7572.08	257	16-7612.15	260
15-3533.20	236	16-7420.30	253	16-7552.10	257	16-7572.10	257	16-7612.16	260
15-3540.29	238	16-7420.35	253	16-7552.12	257	16-7572.12	257	16-7612.18	260
15-3541.28	238	16-7420.90	253	16-7552.15	257	16-7574.07	258	16-7612.20	260
15-3564.01	237	16-7430.00	254	16-7552.18	257	16-7576.13	258	16-7612.22	260
15-3564.02	237	16-7430.09	254	16-7552.20	257	16-7577.25	258	16-7614.10	260
15-3564.03	237	16-7430.14	254	16-7552.22	257	16-7578.08	258	16-7614.12	260

16-7614.14	260	16-7690.16	260	18-1017.23	270	18-1253.07	276	18-1420.55	282
16-7614.15	260	16-7690.18	260	18-1017.26	270	18-1253.11	276	18-1422.03	280
16-7614.16	260	16-7690.20	260	18-1019.14	270	18-1253.15	276	18-1422.05	280
16-7614.18	260	16-7690.21	260	18-1020.00	271	18-1253.18	276	18-1422.53	282
16-7614.20	260	16-7702.16	261	18-1021.00	271	18-1260.08	276	18-1424.03	280
16-7614.22	260	16-7702.21	261	18-1025.01	271	18-1260.11	276	18-1424.05	280
16-7616.10	260	16-7712.09	261	18-1025.02	271	18-1260.14	276	18-1424.48	282
16-7616.12	260	16-7712.10	261	18-1026.35	271	18-1260.17	276	18-1426.03	280
16-7616.14	260	16-7712.12	261	18-1026.50	271	18-1290.21	277	18-1426.05	280
16-7616.15	260	16-7712.15	261	18-1027.00	271	18-1295.06	277	18-1426.50	282
16-7616.16	260	16-7712.20	261	18-1028.00	271	18-1295.07	277	18-1426.68	282
16-7616.18	260	16-7714.18	261	18-1051.20	272	18-1295.08	277	18-1427.03	280
16-7616.20	260	16-7714.27	261	18-1052.20	272	18-1295.09	277	18-1427.05	280
16-7616.22	260	16-7715.01	261	18-1053.20	272	18-1295.10	277	18-1429.03	280
16-7616.25	260	16-7716.02	261	18-1056.19	272	18-1295.11	277	18-1429.05	280
16-7620.25	266	16-7718.01	261	18-1056.28	272	18-1295.12	277	18-1430.60	282
16-7622.25	266	16-7718.02	261	18-1058.19	272	18-1297.06	277	18-1431.73	283
16-7624.24	266	16-7719.01	261	18-1058.28	272	18-1297.07	277	18-1432.60	282
16-7628.25	266	16-7719.02	261	18-1061.16	272	18-1297.08	277	18-1433.73	283
16-7628.35	266	16-7971.26	264	18-1064.18	273	18-1297.09	277	18-1434.50	282
16-7631.10	260	16-7973.35	264	18-1068.20	272	18-1297.10	277	18-1435.63	283
16-7631.12	260	16-7981.25	264	18-1069.20	272	18-1297.11	277	18-1438.75	282
16-7631.14	260	16-7981.30	264	18-1070.29	273	18-1297.12	277	18-1440.68	282
16-7631.15	260	16-7981.35	264	18-1080.19	273	18-1298.12	277	18-1442.65	282
16-7631.16	260	16-7981.40	264	18-1081.19	273	18-1301.16	277	18-1444.58	282
16-7631.18	260	16-7981.50	264	18-1083.19	273	18-1305.17	277	18-1450.80	282
16-7631.20	260	16-7982.25	264	18-1090.33	274	18-1305.27	277	18-1451.00	283
16-7631.22	260	16-7982.30	264	18-1092.30	274	18-1320.01	278	18-1452.75	282
16-7631.25	260	16-7982.35	264	18-1092.40	274	18-1320.02	278	18-1453.93	283
16-7632.10	260	16-7982.40	264	18-1092.50	274	18-1320.03	278	18-1454.65	282
16-7632.12	260	16-7982.50	264	18-1092.60	274	18-1322.01	278	18-1455.80	283
16-7632.15	260	16-7983.35	264	18-1092.70	274	18-1322.02	278	18-1461.12	283
16-7632.16	260	16-7983.40	264	18-1094.00	274	18-1322.03	278	18-1463.11	283
16-7632.18	260	16-7983.60	264	18-1096.21	273	18-1330.01	278	18-1470.30	281
16-7632.20	260	16-7986.21	264	18-1141.25	274	18-1330.02	278	18-1470.68	282
16-7632.22	260	16-7988.21	264	18-1143.21	274	18-1330.03	278	18-1471.30	281
16-7632.25	260	16-7990.00	265	18-1145.21	274	18-1332.01	278	18-1472.30	281
16-7635.18	266	16-7990.01	265	18-1147.21	274	18-1332.02	278	18-1480.35	281
16-7635.23	266	16-7990.02	265	18-1149.22	275	18-1332.03	278	18-1480.38	282
16-7639.22	266	16-7990.03	265	18-1151.24	275	18-1340.01	278	18-1481.35	281
16-7680.45	267	16-7990.04	265	18-1155.20	275	18-1340.02	278	18-1482.35	281
16-7680.70	267	16-7996.29	265	18-1161.01	275	18-1340.03	278	18-1483.35	281
16-7681.05	267	16-7996.37	265	18-1161.02	275	18-1342.01	278	18-1484.33	281
16-7682.45	267	16-7996.42	265	18-1161.03	275	18-1342.02	278	18-1490.30	281
16-7682.70	267	16-7996.49	265	18-1170.20	275	18-1342.03	278	18-1492.35	281
16-7683.25	267	16-7998.30	265	18-1210.23	276	18-1344.25	279	18-1494.35	281
16-7683.35	267	18-1011.15	270	18-1211.23	276	18-1352.01	279	18-1496.33	281
16-7683.50	267	18-1011.19	270	18-1213.23	276	18-1352.02	279	18-1498.30	281
16-7684.00	267	18-1013.15	270	18-1250.07	276	18-1352.03	279	18-1510.40	281
16-7690.13	260	18-1013.19	270	18-1250.11	276	18-1358.20	279	18-1511.40	281
16-7690.14	260	18-1015.23	270	18-1250.15	276	18-1420.03	280	18-1512.38	281
16-7690.15	260	18-1015.26	270	18-1250.18	276	18-1420.05	280	18-1513.38	281

GENERAL SURGERY.

18-1514.35	281	19-1180.01	288	19-1351.01	294	19-1485.13	298	19-2850.65	316
18-1515.35	281	19-1180.02	288	19-1351.02	294	19-1487.14	298	19-2850.70	316
18-1518.50	281	19-1180.03	288	19-1351.03	294	19-1501.06	298	19-2850.80	316
18-1566.40	281	19-1181.01	288	19-1353.13	293	19-1501.10	298	19-2850.90	316
18-1572.21	283	19-1181.02	288	19-1355.13	293	19-1501.12	298	19-2851.00	316
18-1574.21	283	19-1181.03	288	19-1357.13	294	19-1511.13	299	19-2851.01	316
18-4800.01	280	19-1183.13	288	19-1363.01	294	19-1513.14	299	19-3515.28	315
18-4800.02	280	19-1185.13	288	19-1363.02	294	19-1515.14	299	19-3516.28	315
18-4800.03	280	19-1187.13	289	19-1370.12	294	19-1517.09	299	19-3517.45	315
18-4800.04	280	19-1202.01	289	19-1372.13	294	19-1521.12	299	19-3518.00	315
18-4800.05	280	19-1202.02	289	19-1373.13	294	19-1523.12	299	19-3519.00	315
18-4850.01	280	19-1202.03	289	19-1376.13	294	19-1525.05	299	19-3520.00	315
18-4850.02	280	19-1208.12	292	19-1377.13	295	19-1525.07	299	19-3521.00	315
18-4850.03	280	19-1209.12	292	19-1380.13	295	19-1525.10	299	19-3910.00	316
18-4850.04	280	19-1210.01	289	19-1381.13	295	19-1542.12	300	19-3912.00	316
18-4850.05	280	19-1210.02	289	19-1383.13	295	19-1544.12	300	19-5010.05	310
18-4880.01	280	19-1210.03	289	19-1386.13	295	19-1546.13	300	19-5010.10	310
18-4880.02	280	19-1211.12	289	19-1402.05	295	19-1548.13	300	19-5012.05	310
18-4880.03	280	19-1214.04	289	19-1402.10	295	19-1583.07	300	19-5012.10	310
18-4880.04	280	19-1214.08	289	19-1402.15	295	19-1589.13	300	19-5020.11	309
18-4880.05	280	19-1218.12	290	19-1402.18	295	19-1590.06	300	19-5022.11	309
19-0100.03	286	19-1221.11	290	19-1402.20	295	19-1593.09	300	19-7010.01	302
19-0100.04	286	19-1226.12	290	19-1402.25	295	19-1602.01	301	19-7011.01	302
19-0101.07	286	19-1228.12	290	19-1402.35	295	19-1602.02	301	19-7011.02	302
19-0102.05	286	19-1231.12	290	19-1402.40	295	19-1602.03	301	19-7012.01	302
19-0102.07	286	19-1233.13	290	19-1402.45	295	19-1605.12	301	19-7013.01	302
19-0103.08	286	19-1240.01	291	19-1404.10	296	19-1605.34	301	19-7013.02	302
19-0104.07	286	19-1240.02	291	19-1404.20	296	19-1605.56	301	19-7020.07	302
19-0104.09	286	19-1240.03	291	19-1404.25	296	19-1608.12	301	19-7021.07	302
19-0105.08	286	19-1240.04	291	19-1404.30	296	19-1614.00	301	19-7022.07	302
19-0106.07	286	19-1245.12	290	19-1404.35	296	19-1614.01	301	19-7023.07	302
19-0107.07	286	19-1253.12	290, 291	19-1407.13	297	19-1614.12	301	19-7030.01	303
19-0108.05	286	19-1256.12	291	19-1410.01	296	19-1614.23	301	19-7031.01	303
19-0110.07	286	19-1258.12	291	19-1410.02	296	19-1614.34	301	19-7031.02	303
19-0111.07	286	19-1262.12	291	19-1412.01	296	19-1614.45	301	19-7032.01	303
19-0112.05	287	19-1271.11	291	19-1412.02	296	19-1614.56	301	19-7033.01	303
19-0112.07	287	19-1273.13	292	19-1414.02	297	19-1614.67	301	19-7033.02	303
19-0113.08	287	19-1304.12	292	19-1420.01	296	19-1614.78	301	19-7050.07	307
19-0115.08	287	19-1305.12	292	19-1420.02	296	19-1616.00	301	19-7052.07	307
19-0130.07	287	19-1310.13	292	19-1420.03	296	19-1616.01	301	19-7054.10	307
19-0132.07	287	19-1311.13	292	19-1424.13	297	19-1616.12	301	19-7061.07	304
19-0190.08	287	19-1314.13	292	19-1441.01	297	19-1616.23	301	19-7063.07	304
19-0192.08	287	19-1321.12	292	19-1441.02	297	19-1616.34	301	19-7081.07	304
19-0193.07	287	19-1325.13	292	19-1443.13	297	19-1616.45	301	19-7091.07	304
19-0194.03	287	19-1327.12	293	19-1445.13	297	19-1616.56	301	19-7093.07	304
19-0195.07	287	19-1330.13	293	19-1447.13	297	19-1616.67	301	19-7095.07	304
19-0301.11	287	19-1331.11	293	19-1449.01	297	19-1616.78	301	19-7102.08	306
19-1120.00	288	19-1332.12	293	19-1449.02	297	19-1750.17	317	19-7104.08	306
19-1120.01	288	19-1334.12	293	19-1461.13	298	19-2810.00	316	19-7106.08	306
19-1120.02	288	19-1336.12	293	19-1462.13	298	19-2850.50	316	19-7108.08	306
19-1120.03	288	19-1340.13	293	19-1467.13	298	19-2850.55	316	19-7120.08	303
19-1142.13	288	19-1342.12	293	19-1482.20	298	19-2850.60	316	19-7121.08	303

19-7122.08	303	19-7730.09	310	20-3570.03	322	20-4631.04	324	20-4875.08	330
19-7123.08	303	19-7751.10	308	20-3570.04	322	20-4631.05	324	20-5010.40	330
19-7210.01	312	19-7753.10	308	20-3570.05	322	20-4633.01	324	20-5012.55	330
19-7210.03	312	19-7755.20	308	20-3571.00	322	20-4633.02	324	20-5013.55	330
19-7210.05	312	19-7755.27	308	20-3874.01	323	20-4633.03	324	20-5015.55	330
19-7210.10	312	19-7757.08	307	20-4075.00	323	20-4633.04	324	20-5017.55	330
19-7210.15	312	19-7801.09	306	20-4076.01	323	20-4633.05	324	20-5020.70	330
19-7211.05	312	19-7810.01	305	20-4080.00	323	20-4650.18	325	20-5021.70	330
19-7211.10	312	19-7810.02	305	20-4091.00	323	20-4651.16	325	20-5022.70	330
19-7211.15	312	19-7812.10	305	20-4191.00	324	20-4653.16	325	20-5050.40	331
19-7231.07	304	19-7814.10	305	20-4191.01	324	20-4660.15	325	20-5052.40	331
19-7233.07	304	19-7816.11	306	20-4191.03	324	20-4662.18	326	20-5053.60	331
19-7235.07	305	19-7818.11	306	20-4191.04	324	20-4664.17	326	20-5055.60	331
19-7237.07	305	19-7820.11	306	20-4191.15	324	20-4665.17	326	20-5057.40	331
19-7240.07	312	19-7840.09	305	20-4191.17	324	20-4670.12	326	20-5059.40	331
19-7242.10	312	19-7842.09	305	20-4191.22	324	20-4671.12	326	20-5060.35	331
19-7244.10	312	19-7875.05	308	20-4596.50	324	20-4680.01	326	20-5062.45	331
19-7250.08	313	19-7910.09	317	20-4596.75	324	20-4680.02	326	20-5063.45	331
19-7252.08	313	19-7916.08	317	20-4597.10	324	20-4680.03	326	20-5065.45	331
19-7255.10	313	19-7924.09	317	20-4597.15	324	20-4690.01	327	20-5067.50	331
19-7257.10	313	19-7936.09	317	20-4609.00	325	20-4690.02	327	20-5069.50	331
19-7360.01	314	19-7940.09	317	20-4610.00	325	20-4692.01	327	20-5070.50	331
19-7360.02	314	19-7951.10	317	20-4610.01	325	20-4692.02	327	20-5070.70	331
19-7362.11	314	20-2010.00	320	20-4610.02	325	20-4692.03	327	20-5071.40	331
19-7405.10	311	20-2010.30	320	20-4610.03	325	20-4692.04	327	20-5073.30	331
19-7411.10	310	20-2010.45	320	20-4610.04	325	20-4701.12	327	20-5075.60	331
19-7412.10	310	20-2010.55	320	20-4610.05	325	20-4703.12	327	20-5077.60	331
19-7421.10	311	20-2010.65	320	20-4611.00	325	20-4706.14	327	20-5081.30	331
19-7423.10	311	20-2010.75	320	20-4612.00	325	20-4706.16	327	20-5083.30	331
19-7427.07	310	20-2012.00	320	20-4612.01	325	20-4720.16	328	20-5085.01	332
19-7451.10	311	20-2012.55	320	20-4612.02	325	20-4722.17	328	20-5085.02	332
19-7453.10	311	20-2012.65	320	20-4612.03	325	20-4725.02	328	20-5087.01	332
19-7455.10	311	20-2012.75	320	20-4612.04	325	20-4841.12	328	20-5087.02	332
19-7457.09	310	20-2014.00	320	20-4612.05	325	20-4841.14	328	20-5110.00	332
19-7463.07	311	20-2014.45	320	20-4614.00	325	20-4843.14	328	20-5112.00	332
19-7475.06	311	20-2014.55	320	20-4615.00	325	20-4845.12	328	20-5113.00	332
19-7477.06	311	20-2014.65	320	20-4615.01	325	20-4851.10	329	20-5115.00	332
19-7570.10	307	20-2014.75	320	20-4615.02	325	20-4853.11	329	20-5117.00	332
19-7571.10	308	20-2015.00	320	20-4615.03	325	20-4855.08	330	20-5119.00	332
19-7576.10	307	20-2015.45	320	20-4615.04	325	20-4857.08	330	20-5120.00	333
19-7609.01	314	20-2015.55	320	20-4615.05	325	20-4861.08	329	20-5122.00	333
19-7609.02	314	20-2015.65	320	20-4616.00	325	20-4861.14	329	20-5123.00	333
19-7609.03	314	20-2015.75	320	20-4617.00	325	20-4861.16	329	20-5125.00	333
19-7620.09	314	20-2018.00	321	20-4617.01	325	20-4863.08	329	20-5127.00	333
19-7622.09	314	20-2018.50	321	20-4617.02	325	20-4863.14	329	20-5129.00	333
19-7636.09	314	20-2018.60	321	20-4617.03	325	20-4865.08	329	20-5130.00	333
19-7702.09	309	20-2018.70	321	20-4617.04	325	20-4867.20	329	20-5132.00	333
19-7703.09	309	20-2018.80	321	20-4617.05	325	20-4867.25	329	20-5133.00	333
19-7704.09	309	20-2030.04	321	20-4631.00	324	20-4867.30	329	20-5135.00	333
19-7705.09	309	20-2036.03	321	20-4631.01	324	20-4869.30	329	20-5137.00	333
19-7710.11	309	20-3570.01	322	20-4631.02	324	20-4871.08	330	20-5139.00	333
19-7720.09	309	20-3570.02	322	20-4631.03	324	20-4873.08	329	20-5139.08	333

GENERAL SURGERY.

20-5140.00	333	20-5333.00	335	20-6006.35	337	20-6147.03	339	21-6531.19	345
20-5142.00	333	20-5334.00	335	20-6009.10	337	20-6147.06	339	21-6539.12	347
20-5143.00	333	20-5335.00	335	20-6009.14	337	20-6147.10	339	21-6539.14	347
20-5145.00	333	20-5337.00	335	20-6009.16	337	20-6151.16	339	21-6539.16	347
20-5147.00	333	20-5339.00	335	20-6009.20	337	20-6153.16	339	21-6539.18	347
20-5149.00	333	20-5340.00	335	20-6009.26	337	20-6155.16	339	21-6551.15	347
20-5210.00	334	20-5341.00	335	20-6009.28	337	20-6157.16	339	21-6551.18	347
20-5211.00	334	20-5343.00	335	20-6009.30	337	20-6200.01	339	21-6554.20	347
20-5213.00	334	20-5345.00	335	20-6110.15	338	20-6200.02	339	21-6561.16	348
20-5214.00	334	20-5346.00	335	20-6111.15	338	20-6202.01	339	21-6561.20	348
20-5215.00	334	20-5347.00	335	20-6113.15	338	20-6202.02	339	21-6565.20	348
20-5216.00	334	20-5348.00	335	20-6115.15	338	20-6266.35	340	21-6567.18	348
20-5217.00	334	20-5349.00	335	20-6120.03	338	20-6266.40	340	21-6569.18	348
20-5219.00	334	20-5550.00	336	20-6120.06	338	20-6266.45	340	21-6571.14	348
20-5220.00	334	20-5551.00	336	20-6120.10	338	20-6266.50	340	21-6573.14	348
20-5221.00	334	20-5553.00	336	20-6122.03	338	20-6302.16	340	21-6581.01	349
20-5222.00	334	20-5554.00	336	20-6122.06	338	20-6303.16	340	21-6581.02	349
20-5223.00	334	20-5555.00	336	20-6122.10	338	20-6305.16	340	21-6581.03	349
20-5225.00	334	20-5556.00	336	20-6122.12	338	20-6307.20	340	21-6585.18	349
20-5227.00	334	20-5557.00	336	20-6122.15	338	20-6310.02	340	21-6591.01	349
20-5228.00	334	20-5559.00	336	20-6122.20	338	20-6310.03	340	21-6591.02	349
20-5229.00	334	20-5560.00	336	20-6122.25	338	20-6312.13	340	21-6591.03	349
20-5231.00	334	20-5561.00	336	20-6124.03	338	21-6450.01	344	21-6591.04	349
20-5233.00	334	20-5562.00	336	20-6124.06	338	21-6450.02	344	21-6595.01	349
20-5234.00	334	20-5563.00	336	20-6124.10	338	21-6450.03	344	21-6595.02	349
20-5235.00	334	20-5565.00	336	20-6124.12	338	21-6450.04	344	21-6597.01	349
20-5237.00	334	20-5567.00	336	20-6124.15	338	21-6450.05	344	21-6597.02	349
20-5239.00	334	20-5586.00	336	20-6124.20	338	21-6450.06	344	21-6630.60	350
20-5240.00	334	20-5587.00	336	20-6124.25	338	21-6450.07	344	21-6631.01	350
20-5241.00	334	20-5588.00	336	20-6125.05	338	21-6460.01	344	21-6631.02	350
20-5243.00	334	20-5589.00	336	20-6125.10	338	21-6460.02	344	21-6635.05	350
20-5245.00	334	20-5650.00	336	20-6130.03	339	21-6460.03	344	21-6635.07	350
20-5246.00	335	20-5651.00	336	20-6130.06	339	21-6502.01	344	21-6635.09	350
20-5247.00	335	20-5653.00	336	20-6130.10	339	21-6502.02	344	21-6635.11	350
20-5248.00	335	20-5654.00	336	20-6132.03	339	21-6502.03	344	21-6637.05	350
20-5249.00	335	20-5655.00	336	20-6132.06	339	21-6512.01	344	21-6637.07	350
20-5310.00	334	20-5657.00	336	20-6132.10	339	21-6512.02	344	21-6637.09	350
20-5311.00	334	20-5659.00	336	20-6133.05	338	21-6512.03	344	21-6651.21	351
20-5313.00	334	20-5660.00	336	20-6133.10	338	21-6513.03	345	21-6703.03	351
20-5314.00	334	20-5662.00	336	20-6135.05	338	21-6516.13	345	21-6703.04	351
20-5315.00	334	20-5663.00	336	20-6135.10	338	21-6520.35	345	21-6703.05	351
20-5316.00	334	20-5665.00	336	20-6136.15	338	21-6520.50	345	21-6703.06	351
20-5317.00	334	20-5667.00	336	20-6137.15	338	21-6520.75	345	21-6705.01	351
20-5319.00	334	20-5686.00	336	20-6141.03	339	21-6520.90	345	21-6711.10	352
20-5320.00	334	20-5687.00	336	20-6141.06	339	21-6524.35	346	21-6711.25	352
20-5322.00	335	20-5688.00	336	20-6141.10	339	21-6524.50	346	21-6711.40	352
20-5323.00	335	20-5689.00	336	20-6143.03	339	21-6524.75	346	21-6715.20	352
20-5325.00	335	20-6001.01	337	20-6143.06	339	21-6524.90	346	21-6720.20	351
20-5327.00	335	20-6001.02	337	20-6143.10	339	21-6526.35	346	21-6723.19	352
20-5328.00	335	20-6003.15	337	20-6145.03	339	21-6526.50	346	21-6725.19	352
20-5329.00	335	20-6004.15	337	20-6145.06	339	21-6526.75	346	21-6740.15	353
20-5331.00	335	20-6005.15	337	20-6145.10	339	21-6526.90	346	21-6740.18	353

21-6740.20	353	21-6870.05	358	21-7007.01	364	22-7572.13	372	23-7843.24	378
21-6741.03	353	21-6870.06	358	21-7007.02	364	22-7574.09	372	23-7851.19	378
21-6751.26	353	21-6870.07	358	21-7007.03	364	22-7574.11	372	23-7865.22	379
21-6752.24	353	21-6872.10	359	21-7007.04	364	22-7574.13	372	23-7867.22	379
21-6755.03	353	21-6872.12	359	21-7007.05	364	22-7574.15	372	23-7881.19	379
21-6770.16	354	21-6872.14	359	21-7007.06	364	22-7580.11	373	23-7883.19	379
21-6771.16	354	21-6872.16	359	21-7020.01	364	22-7580.13	373	23-7885.19	379
21-6772.16	354	21-6873.01	358	21-7020.02	364	22-7580.15	373	23-7887.19	379
21-6773.16	354	21-6873.02	358	21-7020.03	364	22-7581.11	373	23-7891.19	379
21-6774.15	354	21-6873.03	358	21-7020.04	364	22-7581.13	373	23-7893.19	379
21-6775.19	354	21-6882.05	359	21-7020.05	364	22-7581.15	373	23-7902.19	380
21-6776.16	354	21-6884.04	359	21-7020.06	364	22-7585.09	372	23-7903.19	380
21-6779.16	354	21-6884.06	359	21-7030.01	365	22-7585.11	372	23-7905.18	380
21-6780.15	354	21-6884.08	359	21-7030.02	365	22-7585.13	372	23-7905.23	380
21-6782.15	355	21-6886.16	359	21-7030.03	365	22-7585.15	372	23-7907.21	380
21-6784.15	355	21-6887.16	359	21-7030.04	365	22-7610.00	373	23-7909.20	380
21-6785.15	355	21-6889.16	359	21-7036.01	365	22-7610.01	373	23-7911.21	380
21-6790.03	355	21-6902.16	360	21-7036.02	365	22-7610.02	373	23-7913.21	380
21-6790.04	355	21-6904.18	360	21-7036.03	365	22-7610.03	373	23-7919.22	380
21-6790.05	355	21-6907.18	360	21-7036.04	365	22-7610.04	373	23-7931.14	381
21-6792.03	355	21-6907.19	360	21-7041.01	366	22-7610.05	373	23-7950.28	381
21-6792.04	355	21-6911.21	360	21-7041.02	366	22-7610.10	373	23-7952.28	381
21-6792.05	355	21-6913.21	360	21-7041.03	366	22-7615.00	374	23-7956.28	381
21-6798.16	355	21-6914.16	360	21-7042.01	366	22-7615.01	374	23-7957.40	381
21-6810.04	356	21-6916.16	360	21-7042.02	366	22-7615.02	374	23-7957.50	381
21-6810.05	356	21-6918.21	360	21-7042.03	366	22-7615.03	374	23-7959.03	381
21-6813.19	356	21-6920.21	361	22-7502.16	370	22-7615.10	374	23-7960.00	381
21-6815.18	356	21-6922.01	361	22-7505.16	370	22-7620.00	374	23-7970.00	382
21-6817.19	356	21-6922.03	361	22-7507.19	370	22-7620.01	374	23-7990.02	382
21-6819.19	356	21-6922.05	361	22-7509.19	370	22-7620.02	374	23-7990.05	382
21-6821.23	356	21-6922.07	361	22-7511.15	370	22-7620.03	374	23-7990.10	382
21-6823.22	356	21-6922.09	361	22-7515.01	370	22-7620.10	374	23-7993.00	382
21-6825.16	357	21-6926.16	361	22-7515.02	370	22-7660.10	375	23-7993.45	382
21-6825.19	357	21-6927.16	361	22-7517.11	370	22-7665.10	375	23-7993.90	382
21-6826.22	356	21-6929.16	361	22-7519.14	370	22-7671.01	375	24-8001-22	386
21-6828.21	357	21-6932.19	362	22-7527.14	371	22-7671.02	375	24-8003-22	386
21-6830.22	357	21-6934.19	362	22-7527.16	371	22-7671.03	375	24-8011.18	386
21-6850.04	357	21-6935.01	362	22-7527.18	371	22-7701.22	375	24-8015.01	386
21-6851.04	357	21-6935.02	362	22-7529.12	371	22-7701.23	375	24-8015.02	386
21-6854.04	357	21-6951.16	363	22-7529.14	371	22-7701.24	375	24-8015.03	386
21-6854.07	357	21-6956.14	362	22-7529.16	371	22-7703.22	375	24-8015.04	386
21-6854.09	357	21-6956.16	362	22-7530.11	371	22-7703.23	375	24-8021.24	386
21-6854.12	357	21-6957.17	362	22-7535.19	371	22-7703.24	375	24-8030.00	387
21-6855.06	357	21-6959.20	362	22-7550.16	371	23-7803.18	378	24-8031.20	387
21-6858.04	358	21-6960.18	362	22-7550.18	371	23-7803.20	378	24-8032.20	387
21-6858.07	358	21-6962.18	362	22-7555.16	371	23-7803.22	378	24-8032.30	387
21-6858.09	358	21-6971.23	363	22-7555.99	371	23-7809.24	378	24-8032.40	387
21-6858.12	358	21-6972.23	363	22-7565.12	372	23-7811.23	378	24-8032.50	387
21-6860.04	358	21-6973.23	363	22-7565.14	372	23-7831.22	378	24-8032.60	387
21-6860.07	358	21-6975.23	363	22-7567.12	372	23-7833.22	378	24-8050.00	387
21-6860.12	358	21-6995.15	363	22-7570.16	372	23-7835.23	378	24-8052.00	387
21-6870.04	358	21-7001.21	364	22-7570.19	372	23-7839.25	378	24-8054.00	387

GENERAL SURGERY.

24-8055.00	387	24-8170.18	388	25-1123.33	392	25-1351.23	394	27-1411.21	404
24-8057.00	387	24-8170.20	388	25-1130.16	392	25-1352.16	394	27-1423.35	404
24-8058.02	387	24-8170.22	388	25-1130.23	392	25-1352.23	394	27-1425.35	404
24-8058.03	387	24-8170.24	388	25-1131.16	392	25-1353.16	394	27-1426.34	404
24-8060.02	387	24-8170.26	388	25-1131.23	392	25-1353.23	394	27-1431.26	405
24-8060.03	387	24-8170.28	388	25-1140.16	392	25-1354.16	394	27-1437.27	405
24-8062.00	387	24-8170.30	388	25-1140.23	392	25-1354.23	394	27-1441.36	405
24-8064.01	387	24-8172.08	388	25-1141.16	392	26-1075.75	398	27-1447.28	405
24-8064.02	387	24-8172.10	388	25-1141.23	392	26-1075.90	398	27-1510.16	406
24-8066.00	387	24-8172.12	388	25-1142.16	392	26-1113.14	398	27-1510.20	406
24-8068.01	387	24-8172.14	388	25-1142.23	392	26-1114.14	398	27-1510.25	406
24-8068.02	387	24-8172.16	388	25-1143.16	392	26-1115.07	398	27-1513.13	406
24-8068.03	387	24-8172.18	388	25-1143.23	392	26-1116.15	398	27-1513.17	406
24-8068.04	387	24-8172.20	388	25-1216.16	393	26-1117.17	398	27-1513.18	406
24-8070.00	387	24-8172.22	388	25-1216.23	393	26-1118.16	398	27-1514.75	407
24-8072.01	387	24-8172.24	388	25-1222.16	393	26-1119.16	398	27-1534.75	407
24-8072.02	387	24-8172.26	388	25-1222.23	393	26-1122.16	399	27-1536.25	407
24-8074.00	387	24-8172.28	388	25-1232.16	393	26-1124.16	399	27-1542.18	408
24-8076.00	387	24-8172.30	388	25-1232.23	393	26-1130.13	399	27-1542.26	408
24-8130.01	388	24-8174.12	388	25-1242.16	393	26-1151.05	399	27-1542.30	408
24-8130.02	388	24-8176.10	388	25-1242.23	393	26-1151.07	399	27-1544.13	408
24-8130.03	388	25-1110.16	392	25-1291.16	394	26-1151.09	399	27-1550.06	409
24-8130.04	388	25-1110.23	392	25-1291.23	394	26-1220.04	399	27-1550.07	409
24-8130.05	388	25-1110.26	392	25-1292.16	394	26-1220.05	399	27-1550.12	409
24-8130.06	388	25-1110.33	392	25-1292.23	394	26-1220.06	399	27-1560.09	409
24-8130.07	388	25-1111.16	392	25-1301.16	394	26-1220.07	399	27-1564.16	409
24-8140.01	388	25-1111.23	392	25-1301.23	394	26-1220.08	399	27-1570.00	410
24-8140.02	388	25-1111.26	392	25-1301.26	394	26-1220.09	399	27-1580.19	410
24-8140.03	388	25-1111.33	392	25-1301.33	394	26-1220.10	399	27-1582.14	410
24-8140.04	388	25-1112.16	392	25-1302.16	394	26-1220.11	399	27-1584.16	410
24-8140.05	388	25-1112.23	392	25-1302.23	394	26-1220.12	399	27-1586.16	410
24-8140.06	388	25-1112.26	392	25-1302.26	394	26-1220.13	399	27-1689.32	411
24-8140.07	388	25-1112.33	392	25-1302.33	394	26-1240.04	399	27-1690.20	411
24-8150.01	388	25-1113.16	392	25-1304.16	394	26-1240.05	399	27-1691.20	411
24-8150.02	388	25-1113.23	392	25-1304.23	394	26-1240.06	399	27-1701.30	412
24-8150.03	388	25-1113.26	392	25-1311.16	394	26-1240.07	399	27-1703.29	412
24-8150.04	388	25-1113.33	392	25-1311.23	394	26-1240.08	399	27-1707.24	412
24-8150.05	388	25-1120.16	392	25-1312.16	394	26-1240.09	399	27-1709.22	412
24-8150.06	388	25-1120.23	392	25-1312.23	394	26-1240.10	399	27-1711.22	412
24-8150.07	388	25-1120.26	392	25-1313.16	394	26-1240.11	399	27-1713.22	412
24-8160.01	388	25-1120.33	392	25-1313.23	394	26-1240.12	399	27-1717.23	413
24-8160.02	388	25-1121.16	392	25-1314.16	394	26-1240.13	399	27-1719.23	413
24-8160.03	388	25-1121.23	392	25-1314.23	394	26-1270.00	400	27-1721.23	413
24-8160.04	388	25-1121.26	392	25-1341.16	394	26-1301.15	400	27-1723.23	413
24-8160.05	388	25-1121.33	392	25-1341.23	394	26-1303.16	400	27-1725.15	414
24-8160.06	388	25-1122.16	392	25-1342.16	394	26-1311.21	400	27-1727.26	414
24-8160.07	388	25-1122.23	392	25-1342.23	394	26-1320.15	400	27-1729.26	414
24-8170.08	388	25-1122.26	392	25-1343.16	394	26-1320.20	400	28-1001.23	418
24-8170.10	388	25-1122.33	392	25-1343.23	394	26-1327.17	400	28-1003.23	418
24-8170.12	388	25-1123.16	392	25-1344.16	394	27-1402.23	404	28-1006.20	418
24-8170.14	388	25-1123.23	392	25-1344.23	394	27-1405.22	404	28-1007.20	418
24-8170.16	388	25-1123.26	392	25-1351.16	394	27-1407.22	404	28-1010.20	418

28-1011.20	418	29-1040.20	426	29-1166.24	431	30-1501.24	443	30-1519.22	444
28-1017.22	418	29-1060.16	427	29-1170.15	432	30-1501.26	443	30-1519.24	444
28-1025.28	419	29-1060.18	427	29-1172.07	432	30-1501.28	443	31-1105.22	448
28-1028.35	419	29-1060.20	427	29-1172.10	432	30-1501.30	443	31-1110.15	448
28-1030.13	419	29-1060.24	427	29-1174.00	432	30-1501.32	443	31-1115.15	448
28-1030.18	419	29-1064.16	427	29-1180.05	432	30-1501.34	443	31-1121.22	448
28-1030.21	419	29-1064.20	427	29-1180.07	432	30-1501.36	443	31-1125.17	448
28-1042.34	419	29-1068.16	427	29-1180.10	432	30-1505.08	443	31-1130.19	448
28-1049.00	420	29-1068.20	427	29-1182.26	432	30-1505.09	443	31-1147.00	449
28-1050.00	420	29-1070.18	427	29-1184.08	432	30-1505.10	443	31-1150.15	449
28-1050.01	420	29-1070.20	427	29-1184.23	432	30-1505.11	443	31-1160.00	449
28-1050.02	420	29-1072.20	427	29-1190.30	433	30-1505.12	443	31-1210.22	450
28-1050.03	420	29-1072.23	427	29-1191.30	433	30-1505.14	443	31-1212.16	450
28-1050.04	420	29-1074.20	427	29-1210.15	434	30-1505.16	443	31-1212.19	450
28-1050.05	420	29-1080.16	428	29-1210.21	434	30-1505.18	443	31-1212.22	450
28-1050.06	420	29-1082.22	428	29-1210.29	434	30-1505.20	443	31-1220.05	450
28-1050.07	420	29-1110.18	428	29-1210.35	434	30-1505.22	443	31-1220.10	450
28-1050.08	420	29-1110.21	428	29-1220.00	435	30-1505.24	443	31-1220.14	450
28-1050.09	420	29-1110.23	428	29-1221.00	435	30-1505.26	443	31-1220.20	450
28-1050.10	420	29-1111.18	428	30-1301.21	438	30-1505.28	443	31-1224.21	450
28-1050.11	420	29-1111.21	428	30-1303.21	438	30-1505.30	443	31-1224.27	450
28-1050.12	420	29-1111.23	428	30-1305.21	438	30-1505.32	443	31-1251.01	451
28-1050.13	420	29-1116.16	428	30-1306.20	438	30-1505.34	443	31-1251.02	451
28-1070.21	419	29-1116.18	428	30-1311.23	438	30-1505.36	443	31-1251.03	451
28-1075.27	419	29-1116.21	428	30-1313.23	438	30-1505.38	443	31-1261.41	451
28-1078.01	419	29-1116.23	428	30-1323.23	439	30-1505.39	443	31-1263.30	451
28-1078.02	419	29-1117.16	428	30-1325.24	439	30-1505.40	443	31-1301.28	452
28-1080.17	419	29-1117.18	428	30-1347.27	440	30-1511.08	444	31-1301.35	452
28-1080.21	419	29-1117.21	428	30-1349.27	440	30-1511.10	444	31-1301.42	452
28-1080.24	419	29-1117.23	428	30-1350.00	439	30-1511.12	444	31-1302.28	452
28-1080.27	419	29-1120.22	429	30-1360.00	440	30-1511.14	444	31-1302.35	452
28-1110.32	422	29-1120.25	429	30-1363.00	439	30-1511.16	444	31-1302.42	452
28-1121.21	422	29-1120.28	429	30-1365.00	439	30-1511.18	444	31-1303.28	452
28-1123.21	422	29-1121.22	429	30-1368.20	441	30-1511.20	444	31-1303.35	452
28-1131.01	421	29-1121.25	429	30-1368.28	441	30-1511.22	444	31-1303.42	452
28-1131.02	421	29-1121.28	429	30-1370.00	441	30-1511.24	444	31-1304.28	452
28-1131.03	421	29-1126.22	429	30-1370.01)	441	30-1513.08	444	31-1304.35	452
28-1131.04	421	29-1126.25	429	30-1475.08	441	30-1513.10	444	31-1304.42	452
28-1131.05	421	29-1126.28	429	30-1477.11	441	30-1513.12	444	31-1311.23	452
28-1131.06	421	29-1127.22	429	30-1480.26	442	30-1513.14	444	31-1311.33	452
29-1002.14	426	29-1127.25	429	30-1484.39	442	30-1513.16	444	31-1311.40	452
29-1010.15	426	29-1127.28	429	30-1485.35	442	30-1513.18	444	31-1321.23	452
29-1020.15	426	29-1130.25	430	30-1500.00	443	30-1513.20	444	31-1321.33	452
29-1020.19	426	29-1131.25	430	30-1501.00	443	30-1513.22	444	31-1321.40	452
29-1020.22	426	29-1136.25	430	30-1501.08	443	30-1513.24	444	31-1402.21	451
29-1020.24	426	29-1137.25	430	30-1501.10	443	30-1519.08	444	32-1010.01	456
29-1024.16	426	29-1141.23	431	30-1501.12	443	30-1519.10	444	32-1010.02	456
29-1024.20	426	29-1147.23	431	30-1501.14	443	30-1519.12	444	32-1010.03	456
29-1024.25	426	29-1151.30	431	30-1501.16	443	30-1519.14	444	32-1020.01	456
29-1030.15	426	29-1151.60	431	30-1501.18	443	30-1519.16	444	32-1020.02	456
29-1040.15	426	29-1151.75	431	30-1501.20	443	30-1519.18	444	32-1020.03	456
29-1040.19	426	29-1160.24	431	30-1501.22	443	30-1519.20	444	32-1030.01	456

GENERAL SURGERY.

32-1030.02	456	32-1150.00	460	32-1610.01	464	32-1620.13	465	32-1780.32	471
32-1030.03	456	32-1151.00	460	32-1610.02	464	32-1620.15	465	32-1781.32	471
32-1031.00	456	32-1152.00	460	32-1610.03	464	32-1620.17	465	32-1782.32	471
32-1032.00	456	32-1160.01	461	32-1610.04	464	32-1620.19	465	32-1783.32	471
32-1040.01	457	32-1160.02	461	32-1610.05	464	32-1620.21	465	32-1784.28	471
32-1040.02	457	32-1161.01	461	32-1610.06	464	32-1620.23	465	32-1790.04	472
32-1040.03	457	32-1161.02	461	32-1610.07	464	32-1620.25	465	32-1792.01	472
32-1042.00	457	32-1162.01	461	32-1610.08	464	32-1624.08	465	32-1792.02	472
32-1050.01	457	32-1162.02	461	32-1610.09	464	32-1624.13	465	32-1792.03	472
32-1050.02	457	32-1171.01	461	32-1610.10	464	32-1625.08	465	32-1792.04	472
32-1050.03	457	32-1171.02	461	32-1610.11	464	32-1626.08	465	32-1794.12	472
32-1060.01	457	32-1171.03	461	32-1610.12	464	32-1626.13	465	32-1794.40	472
32-1060.02	457	32-1181.01	461	32-1610.13	464	32-1630.10	466	32-1796.40	472
32-1060.03	457	32-1181.02	461	32-1610.14	464	32-1630.12	466	32-1801.21	473
32-1080.01	458	32-1181.03	461	32-1610.15	464	32-1630.14	466	32-1804.21	473
32-1080.02	458	32-1191.00	461	32-1610.16	464	32-1630.16	466	32-1804.28	473
32-1080.03	458	32-1191.01	461	32-1610.17	464	32-1630.18	466	32-1805.26	473
32-1090.01	458	32-1191.02	461	32-1610.18	464	32-1630.20	466	32-1806.24	473
32-1090.02	458	32-1191.03	461	32-1610.19	464	32-1635.06	466	32-1809.23	473
32-1110.01	458	32-1201.01	462	32-1610.20	464	32-1636.08	466	32-1811.25	473
32-1110.02	458	32-1201.02	462	32-1610.21	464	32-1641.34	466	32-1813.20	474
32-1110.03	458	32-1201.03	462	32-1610.22	464	32-1643.29	466	32-1815.01	474
32-1111.01	458	32-1203.01	462	32-1610.23	464	32-1645.29	466	32-1815.02	474
32-1111.02	458	32-1203.02	462	32-1610.24	464	32-1702.25	467	32-1817.04	474
32-1111.03	458	32-1203.03	462	32-1610.25	464	32-1704.25	467	32-1818.23	474
32-1112.01	458	32-1203.04	462	32-1610.26	464	32-1705.24	467	32-1821.01	475
32-1112.02	458	32-1205.01	462	32-1610.27	464	32-1707.28	467	32-1822.00	475
32-1112.03	458	32-1205.02	462	32-1610.28	464	32-1708.17	467	32-1824.01	476
32-1120.01	459	32-1205.03	462	32-1610.29	464	32-1710.18	467	32-1824.02	476
32-1120.02	459	32-1205.04	462	32-1610.30	464	32-1712.20	468	32-1824.03	476
32-1121.01	459	32-1507.00	462	32-1615.01	464	32-1714.24	468	32-1824.04	476
32-1121.02	459	32-1509.00	462	32-1615.02	464	32-1715.24	468	32-1824.11	476
32-1122.01	459	32-1510.20	463	32-1615.03	464	32-1724.06	468	32-1824.12	476
32-1122.02	459	32-1510.25	463	32-1615.04	464	32-1724.08	468	32-1824.13	476
32-1130.01	459	32-1510.30	463	32-1615.05	464	32-1724.10	468	32-1824.14	476
32-1130.02	459	32-1510.35	463	32-1615.06	464	32-1725.06	468	32-1825.04	475
32-1130.03	459	32-1510.40	463	32-1615.07	464	32-1725.08	468	32-1826.00	475
32-1131.01	459	32-1513.20	463	32-1615.08	464	32-1725.10	468	32-1827.00	477
32-1131.02	459	32-1513.25	463	32-1615.09	464	32-1731.23	469	32-1828.00	477
32-1131.03	459	32-1513.30	463	32-1615.10	464	32-1732.21	469	32-1830.00	477
32-1132.01	459	32-1513.35	463	32-1615.11	464	32-1733.21	469	32-1832.01	478
32-1132.02	459	32-1513.40	463	32-1615.12	464	32-1736.28	469	32-1832.02	478
32-1132.03	459	32-1515.40	463	32-1615.13	464	32-1739.26	469	32-1832.03	478
32-1140.01	460	32-1519.28	463	32-1615.14	464	32-1740.27	470	32-1832.04	478
32-1140.02	460	32-1519.38	463	32-1615.15	464	32-1742.20	470	32-1832.11	478
32-1140.03	460	32-1551.10	463	32-1615.16	464	32-1743.32	470	32-1832.12	478
32-1141.01	460	32-1560.24	463	32-1620.01	465	32-1745.27	470	32-1832.13	478
32-1141.02	460	32-1604.14	464	32-1620.03	465	32-1747.23	470	32-1832.14	478
32-1141.03	460	32-1604.26	464	32-1620.05	465	32-1749.25	470	32-1841.17	479
32-1142.01	460	32-1605.14	464	32-1620.07	465	32-1759.26	469	32-1843.27	479
32-1142.02	460	32-1606.14	464	32-1620.09	465	32-1765.28	471	32-1845.01	479
32-1142.03	460	32-1606.26	464	32-1620.11	465	32-1767.26	471	32-1845.02	479

32-1845.03	479	32-1924.08	482	33-1129.40	486	34-1258.06	496	35-1143.27	503
32-1850.00	479	32-1924.09	482	33-1135.40	487	34-1260.03	496	35-1143.29	503
32-1902.01	480	32-1924.11	482	33-1137.40	487	34-1260.04	496	35-1143.31	503
32-1902.02	480	32-1924.12	482	33-1145.36	487	34-1260.05	496	35-1143.34	503
32-1902.03	480	32-1924.14	482	33-1149.40	487	34-1268.00	497	35-1143.38	503
32-1902.04	480	32-1924.15	482	33-1151.39	487	34-1270.02	497	35-1143.41	503
32-1902.05	480	32-1924.16	482	33-1153.39	487	34-1270.03	497	35-1144.01	503
32-1902.06	480	32-1924.19	482	33-1155.36	487	34-1270.04	497	35-1144.02	503
32-1904.27	480	32-1924.20	482	33-1157.36	488	34-1270.05	497	35-1144.03	503
32-1912.05	481	32-1925.07	482	33-1158.17	488	34-1270.06	497	35-1144.04	503
32-1912.06	481	32-1925.08	482	33-1161.29	488	34-1270.07	497	35-1144.05	503
32-1912.07	481	32-1925.09	482	33-1165.44	488	34-1270.08	497	35-1144.06	503
32-1912.08	481	32-1925.11	482	33-1167.40	488	34-1310.10	497	35-1144.07	503
32-1912.09	481	32-1925.12	482	33-1170.37	488	34-1314.10	497	35-1149.17	504
32-1912.11	481	32-1925.14	482	33-1172.40	488	34-1315.10	497	35-1149.20	504
32-1912.12	481	32-1925.15	482	33-1180.00	489	34-1317.14	498	35-1149.25	504
32-1912.14	481	32-1925.16	482	33-1181.21	489	34-1320.14	498	35-1149.27	504
32-1913.05	481	32-1925.19	482	33-1191.33	489	34-1323.11	498	35-1149.30	504
32-1913.06	481	32-1925.20	482	33-1193.27	489	34-1323.13	498	35-1149.40	504
32-1913.07	481	32-1927.07	482	33-1194.21	489	34-1330.13	498	35-1150.02	504
32-1913.08	481	32-1927.08	482	33-1197.09	489	34-1335.11	498	35-1150.05	504
32-1913.09	481	32-1927.09	482	33-1199.09	489	34-1343.10	498	35-1150.10	504
32-1913.11	481	32-1927.11	482	33-1201.34	490	34-1348.10	497	35-1150.20	504
32-1913.12	481	32-1927.12	482	33-1203.30	490	34-1349.10	497	35-1251.10	502
32-1913.14	481	32-1927.14	482	33-1205.35	490	34-1356.10	497	35-1252.01	504
32-1914.05	481	32-1927.15	482	33-1232.27	490	34-1356.12	497	35-1252.02	504
32-1914.06	481	32-1927.16	482	33-1233.27	490	34-1369.14	497	35-1252.03	504
32-1914.07	481	32-1927.19	482	33-1234.01	490	34-1370.00	497	35-1252.04	504
32-1914.08	481	32-1927.20	482	33-1234.02	490	35-1120.21	502	35-1252.05	504
32-1914.09	481	32-1932.30	483	33-1234.03	490	35-1122.65	502	35-1252.06	504
32-1914.11	481	32-1932.35	483	33-1235.01	490	35-1123.65	502	35-1252.07	504
32-1914.12	481	32-1932.40	483	33-1235.02	490	35-1124.00	502	35-1252.08	504
32-1914.14	481	32-1933.30	483	33-1235.03	490	35-1130.18	503	35-1252.09	504
32-1915.05	481	32-1933.35	483	33-1242.30	491	35-1130.20	503	35-1253.21	505
32-1915.06	481	32-1933.40	483	33-1244.14	491	35-1130.22	503	35-1253.24	505
32-1915.07	481	32-1934.30	483	33-1244.18	491	35-1130.25	503	35-1253.29	505
32-1915.08	481	32-1934.35	483	33-1244.21	491	35-1130.30	503	35-1253.30	505
32-1915.09	481	32-1934.40	483	33-1246.42	491	35-1130.32	503	35-1253.32	505
32-1915.11	481	32-1935.30	483	33-1249.28	489	35-1130.40	503	35-1253.33	505
32-1915.12	481	32-1935.35	483	33-1250.42	492	35-1130.50	503	35-1253.35	505
32-1915.14	481	32-1935.40	483	33-1254.46	492	35-1140.04	503	35-1253.38	505
32-1922.07	482	33-1110.23	486	33-1256.25	492	35-1140.06	503	35-1253.40	505
32-1922.08	482	33-1112.30	486	33-1259.30	492	35-1140.08	503	35-1253.42	505
32-1922.09	482	33-1115.33	486	34-1230.15	496	35-1140.10	503	35-1253.43	505
32-1922.11	482	33-1115.36	486	34-1241.10	496	35-1140.12	503	35-1253.49	505
32-1922.12	482	33-1117.30	486	34-1243.14	496	35-1140.15	503	35-1253.51	505
32-1922.14	482	33-1118.36	486	34-1245.14	496	35-1143.16	503	35-1253.59	505
32-1922.15	482	33-1118.39	486	34-1248.14	496	35-1143.17	503	35-1256.22	505
32-1922.16	482	33-1120.41	487	34-1251.10	496	35-1143.22	503	35-1256.26	505
32-1922.19	482	33-1125.32	486	34-1258.03	496	35-1143.23	503	35-1256.28	505
32-1922.20	482	33-1125.38	486	34-1258.04	496	35-1143.24	503	35-1256.32	505
32-1924.07	482	33-1129.36	486	34-1258.05	496	35-1143.25	503	35-1256.35	505

GENERAL SURGERY.

35-1256.37	505	35-1385.14	506
35-1256.42	505	35-1385.16	506
35-1325.08	506	35-1385.19	506
35-1325.10	506	35-1385.24	506
35-1325.25	506	35-1388.14	506
35-1350.08	506	35-1388.16	506
35-1350.10	506	35-1388.19	506
35-1350.13	506	35-1388.24	506
35-1350.15	506	35-1388.29	506
35-1350.19	506	35-1388.34	506
35-1359.14	506	35-1388.39	506
35-1359.16	506	35-1390.14	506
35-1359.19	506	35-1390.16	506
35-1359.24	506	35-1390.19	506
35-1365.14	506	35-1390.24	506
35-1365.16	506	35-1390.29	506
35-1365.19	506	35-1390.34	506
35-1365.24	506	35-1390.39	506
35-1365.29	506	35-1391.14	506
35-1365.34	506	35-1391.16	506
35-1365.39	506	35-1391.19	506
35-1366.14	506	35-1391.24	506
35-1366.16	506	35-1391.29	506
35-1366.19	506	35-1391.34	506
35-1366.24	506	35-1391.39	506
35-1366.29	506	35-1395.14	506
35-1366.34	506	35-1395.16	506
35-1366.39	506	35-1395.19	506
35-1370.14	506	35-1395.24	506
35-1370.16	506	35-1395.29	506
35-1370.19	506	35-1395.34	506
35-1370.24	506	35-1395.39	506
35-1370.29	506	35-1395.49	506
35-1370.34	506	35-1395.59	506
35-1370.39	506	35-2010.26	505
35-1371.14	506	35-2010.48	505
35-1371.16	506		
35-1371.19	506		
35-1371.24	506		
35-1371.29	506		
35-1371.34	506		
35-1371.39	506		
35-1371.49	506		
35-1371.59	506		
35-1383.08	506		
35-1383.10	506		
35-1383.25	506		
35-1384.08	506		
35-1384.10	506		
35-1384.13	506		
35-1384.15	506		
35-1384.19	506		

¹Any companies mentioned in this catalogue including their brand names and related products are protected under intellectual property laws. The use of them does not imply any affiliation with or endorsement by them.

²Specifications, design and accessories in this catalogue are subject to change without any notice or obligation on the part of the manufacturer.

Copyright by Ackermann Instrumente GmbH. All rights reserved. Specifications, design and accessories in this catalogue are subject to change without any notice or obligation on the part of the manufacturer. No part may be copied or reproduced in any form. Revision 10/21



www.rolan-instruments.de



Ackermann Instrumente GmbH
Eisenbahnstrasse 65-67
78604 Rietheim-Weilheim, Germany